

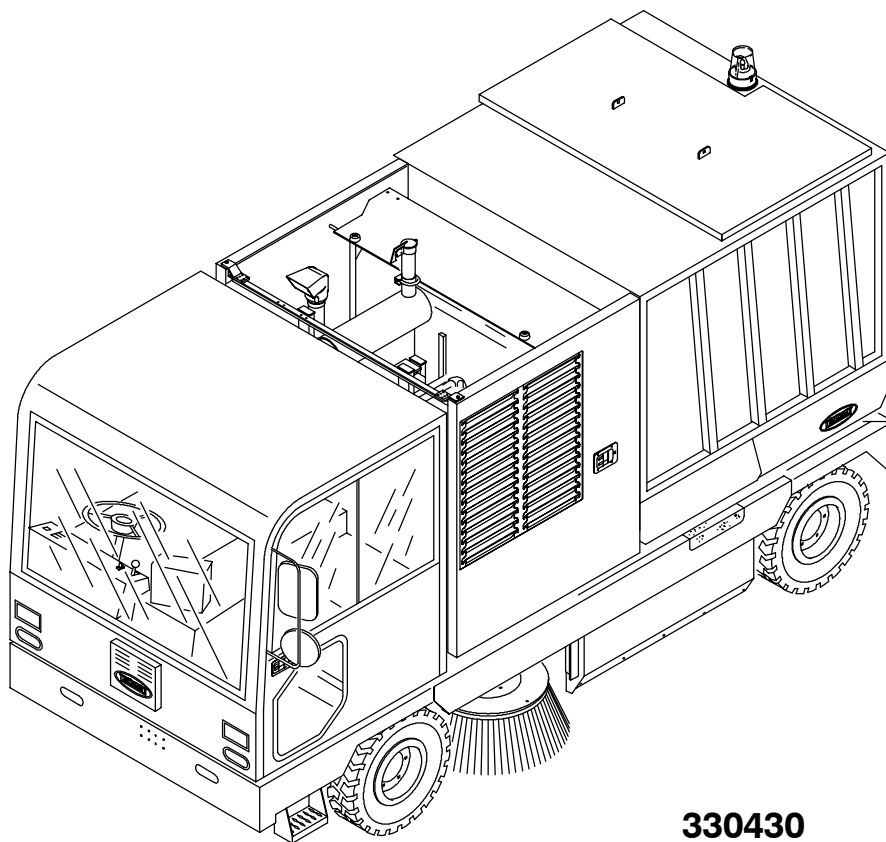

830-II

Operator Manual



330430

Rev. 06





This manual is furnished with each new TENNANT Model 830-II. It provides necessary operating and preventive maintenance instructions. Read this manual completely and understand the machine before operating or servicing it.

This machine will provide excellent service. However, the best results will be obtained at minimum costs if:

- The machine is operated with reasonable care.
- The machine is maintained regularly - per the maintenance instructions provided.
- The machine is maintained with TENNANT supplied or equivalent parts.

Manual Number - 330430

Revision: 06

Published: 12-02



CALIFORNIA PROPOSITION 65 WARNING: Engine exhaust from this product contains chemicals known to the State of California to cause cancer, birth defects, or other reproductive harm.

CONTENTS

	Page		Page
SAFETY PRECAUTIONS	4	ENGINE SHUTDOWN	
OPERATION	8	OVERRIDE SWITCH	30
OPERATOR RESPONSIBILITY	8	PARKING BRAKE SWITCH	30
MACHINE COMPONENTS	9	LEFT SIDE BRUSH	
CONTROL PANEL SYMBOLS	10	WATER VALVE KNOB (OPTION) .	31
CONTROLS AND INSTRUMENTS	12	VARIO SWEEPING BRUSH™ LEFT	
OPERATION OF CONTROLS	17	WATER VALVE KNOB (OPTION) .	31
OPERATOR SEAT	17	VARIO SWEEPING BRUSH™ RIGHT	
SEAT BELTS	17	WATER VALVE KNOB (OPTION) .	32
STEERING WHEEL	18	RIGHT SIDE BRUSH	
STEERING WHEEL TILT LEVER	18	WATER VALVE KNOB (OPTION) .	32
PARKING LIGHTS, HEADLIGHTS,		FUSES	33
BRIGHT HEADLIGHTS, SIGNAL,		ENGINE WATER	
AND HORN SWITCH	19	TEMPERATURE GAUGE	34
WINDSHIELD WIPER AND		FUEL LEVEL GAUGE	34
WASHER SWITCH	19	ENGINE OIL PRESSURE GAUGE ..	34
IGNITION SWITCH	20	VOLTMETER	35
PROPELLING PEDAL	20	HOURMETER	35
BRAKE PEDAL	20	ODOMETER	35
VARIO SWEEPING BRUSH™		SPEEDOMETER	35
LOCK PIN (OPTION)	21	TACHOMETER	36
VARIO SWEEPING BRUSH™		SWITCH PANEL	37
JOYSTICK (OPTION)	21	HOPPER TILT BACK SWITCH	37
VARIO SWEEPING BRUSH™		HOPPER TILT FORWARD SWITCH .	37
SWING SWITCH (OPTION)	22	HOPPER LIFT SWITCH	
VARIO SWEEPING BRUSH™		(High Dump Model)	38
FRONT ANGLE		HOPPER LOWER SWITCH	
SWITCH (OPTION)	22	(High Dump Model)	38
VARIO SWEEPING BRUSH™		HOPPER DOOR OPEN SWITCH	39
SIDE ANGLE SWITCH (OPTION)	23	HOPPER DOOR CLOSE SWITCH ..	39
VARIO SWEEPING BRUSH™		WATER PUMP SWITCH (OPTION) ..	39
ON-OFF SWITCH (OPTION)	23	LEFT SIDE BRUSH	
ACCESSORY POWER SOCKET	24	SWITCH (OPTION)	40
DIRECTIONAL LEVER	24	RIGHT SIDE BRUSH SWITCH	40
THROTTLE LEVER	24	FILTER SHAKER SWITCH	40
BRIGHT HEADLIGHTS LIGHT	25	CONVEYOR REVERSE SWITCH ...	41
PARKING BRAKE LIGHT	25	VACUUM FAN SWITCH	41
SIGNAL LIGHT	25	SWEEP SWITCH	42
GLOW PLUGS LIGHT	25	4-WAY WARNING LIGHTS SWITCH .	43
CLOGGED ENGINE		HAZARD LIGHT SWITCH	43
AIR FILTER LIGHT	26	SIDE BRUSH SPOT LIGHT(S)	
WATER TANK LOW LIGHT (OPTION)	26	SWITCH	43
VACUUM WAND DOOR		REAR NIGHT SWEEPING LIGHT	
LIGHT (OPTION)	27	SWITCH (OPTION)	44
HOPPER OVERLOAD LIGHT	27	FRONT NIGHT SWEEPING LIGHT	
HEATER KNOB	28	SWITCH (OPTION)	44
FAN KNOB	28	HIGH PRESSURE WASHER	
AIR CONDITIONER KNOB (OPTION)	28	SWITCH (OPTION)	44
AIR CIRCULATION VENTS	29	DOME AND MAP LIGHT SWITCH ...	45
LOW BRAKE PRESSURE LIGHT ...	29	RADIO AND CASSETTE PLAYER	
INCLINE LIGHT (High Dump Model) .	29	(OPTION)	45
		LATCHES	45
		HOPPER SUPPORT PIN	46
		HOPPER SUPPORT BAR	
		(High Dump Model)	47

CONTENTS

	Page		Page
HOW THE MACHINE WORKS	48	ENGINE	90
PRE-OPERATION CHECKLIST	48	COOLING SYSTEM	90
STARTING THE MACHINE	49	AIR FILTER	91
SWEEPING AND BRUSH INFORMATION	52	AIR INTAKE SCREEN	92
SWEEPING	53	FUEL FILTER	92
STOP SWEEPING	57	FUEL WATER SEPARATOR	92
EMPTYING THE HOPPER	59	FUEL LINES	93
STOP THE MACHINE	63	PRIMING FUEL SYSTEM	94
POST-OPERATION CHECKLIST	64	TO PRIME FUEL SYSTEM	94
ENGAGING HOPPER SUPPORT PIN ..	65	CAB FILTERS	96
DISENGAGING HOPPER SUPPORT PIN	66	WET DUST CONTROL	
ENGAGING HOPPER SUPPORT BAR		FILTER (OPTION)	96
(High Dump Model)	67	WINDSHIELD WIPER BLADES	97
DISENGAGING HOPPER SUPPORT BAR		WINDSHIELD WASHER FLUID	97
(High Dump Model)	69	BATTERY	97
OPERATION ON INCLINES	70	BELTS AND CHAINS	98
OPTIONS	71	ENGINE BELT	98
VARIO SWEEPING BRUSH™	71	AIR CONDITIONER BELT (OPTION)	98
WET DUST CONTROL SYSTEM	73	STATIC DRAG CHAIN	98
VACUUM WAND	75	DEBRIS HOPPER	99
MACHINE TROUBLESHOOTING	78	HOPPER DUST FILTER	99
MAINTENANCE	80	TO REMOVE OR REPLACE	
MAINTENANCE CHART	80	HOPPER DUST FILTER	99
LUBRICATION	82	THERMO SENTRY™	100
A. HOPPER TILT (LOW DUMP)	83	CONVEYOR	101
B. HOPPER LIFT/TILT		BRUSHES	102
(HIGH DUMP OPTION)	83	MAIN BRUSH	102
C. AXLE LEAF SPRINGS	83	TO REPLACE MAIN BRUSH	102
D. STEERING CYLINDER	84	TO CHECK AND ADJUST MAIN	
E. WHEEL PIVOTS POINTS	84	BRUSH PATTERN	105
F. SIDE BRUSH PIVOT	84	SIDE BRUSH	106
G. VARIO SWEEPING BRUSH™		TO REPLACE SIDE BRUSH	106
(OPTION)	85	SKIRTS AND SEALS	107
H. MAIN BRUSH SUPPORT RODS .	85	BRUSH ACCESS DOOR SKIRTS ...	107
I. CONVEYOR BEARINGS	85	BRUSH COMPARTMENT	
J. CONVEYOR CHAIN	86	REAR SKIRT	107
K. ENGINE	86	CONVEYOR SKIRTS	107
L. DIFFERENTIAL	86	DOOR SEALS	108
HYDRAULICS	87	CONVEYOR SEALS	108
HYDRAULIC FLUID RESERVOIR ...	87	HOPPER SEALS	108
HYDRAULIC FLUID	88	SKIDS	109
HYDRAULIC HOSES	89	SKIDS	109
PURGING AIR FROM THE HYDRAULIC			
CONVEYOR LIFT SYSTEM	89		

	Page
BRAKES AND TIRES	109
SERVICE BRAKES	109
PARKING BRAKE	109
TIRES	110
WHEEL ALIGNMENT	110
WHEEL NUTS	110
PUSHING OR TOWING THE MACHINE	111
TRANSPORTING THE MACHINE	112
MACHINE JACKING	114
STORING MACHINE	115
FREEZE PROTECTION FOR WET DUST CONTROL SYSTEM .	115
SPECIFICATIONS	116
GENERAL MACHINE DIMENSIONS/CAPACITIES	116
GENERAL MACHINE PERFORMANCE ..	117
POWER TYPE	117
STEERING	118
HYDRAULIC SYSTEM	118
BRAKING SYSTEM	118
TIRES	118
MACHINE DIMENSIONS	119
INDEX	120

SAFETY PRECAUTIONS

The following precautions are used throughout this manual as indicated in their description:



WARNING: To warn of hazards or unsafe practices which could result in severe personal injury or death.









FOR SAFETY: To identify actions which must be followed for safe operation of equipment.

The machine is suited to sweep disposable debris. Do not use the machine other than described in this Operator Manual.

The following information signals potentially dangerous conditions to the operator or equipment:

FOR SAFETY:

1. **Do not operate machine:**
 - Unless trained and authorized.
 - Unless operation manual is read and understood.
 - In flammable or explosive areas unless designed for use in those areas.
2. **Before starting machine:**
 - Check for fuel leaks.
 - Keep sparks and open flame away from refueling area.
 - Make sure all safety devices are in place and operate properly.
 - Check brakes and steering for proper operation.
3. **When starting machine:**
 - Keep foot on brake and directional pedal in neutral.
4. **When using machine:**
 - Use brakes to stop machine.
 - Go slow on inclines and slippery surfaces.
 - Use care when reversing machine.
 - Move machine with care when hopper is raised.
 - Only dump the hopper on a level surface.
 - Make sure adequate clearance is available before raising hopper.
 - Do not carry riders on machine.
 - Always follow safety and traffic rules.
 - Report machine damage or faulty operation immediately.
5. **Before leaving or servicing machine:**
 - Stop on level surface.
 - Set parking brake.
 - Turn off machine and remove key.
6. **When servicing machine:**
 - Avoid moving parts. do not wear loose jackets, shirts, or sleeves.
 - Block machine tires before jacking machine up.
 - Jack machine up at designated locations only. Block machine up with jack stands.
 - Use hoist or jack that will support the weight of the machine.
 - Wear eye and ear protection when using pressurized air or water.
 - Disconnect battery connections before working on machine.
 - Avoid contact with battery acid.
 - Avoid contact with hot engine coolant.
 - Allow engine to cool.
 - Keep flames and sparks away from fuel system service area. Keep area well ventilated.
 - Use cardboard to locate leaking hydraulic fluid under pressure.
 - Use Tennant supplied or approved replacement parts.
7. **When loading/unloading machine onto/off truck or trailer:**
 - Turn off machine.
 - Use truck or trailer that will support the weight of the machine.
 - Use winch. Do not drive the machine onto/off the truck or trailer unless the load height is 380 mm (15 in) or less from the ground.
 - Set parking brake after machine is loaded.
 - Block machine tires.
 - Tie machine down to truck or trailer.

-  **WARNING: Machine can emit excessive noise. Consult with your regulatory agency for exposure limits. Hearing loss can result. Wear hearing protection.**
-  **WARNING: Raised hopper may fall. Engage hopper support bar.**
-  **WARNING: Raised hopper may fall. Engage hopper support pin.**
-  **WARNING: Brush linkage pinch points. Stay clear when linkage is moving.**
-  **WARNING: Side brush can move. Do not step on side brush.**
-  **WARNING: Hopper door pinch point. Stay clear of hopper door.**
-  **WARNING: High dump vertical clearance. Stay clear of overhead obstructions and power lines.**
-  **WARNING: Conveyor throws debris. Conveyor pinch point. Stay clear when in operation.**
-  **WARNING: Flammable materials can cause explosion or fire. Do not use flammable materials in tank. Only use water.**
-  **WARNING: Engine emits toxic gases. Severe respiratory damage or asphyxiation can result. Provide adequate ventilation. Consult with your regulatory agency for exposure limits. Keep engine properly tuned.**
-  **WARNING: Lift arm pinch point. Stay clear of hopper lift arms.**
-  **WARNING: Raised cab may fall. Engage cab support bar.**

SAFETY PRECAUTIONS

The following safety labels are mounted on the machine in the locations indicated. If these or any label becomes damaged or illegible, install a new label in its place.

EMISSIONS LABEL -
Located on the upper console.



HIGH DUMP LABEL -
Located on the upper console.



FOR SAFETY LABEL -
Located on the upper console.

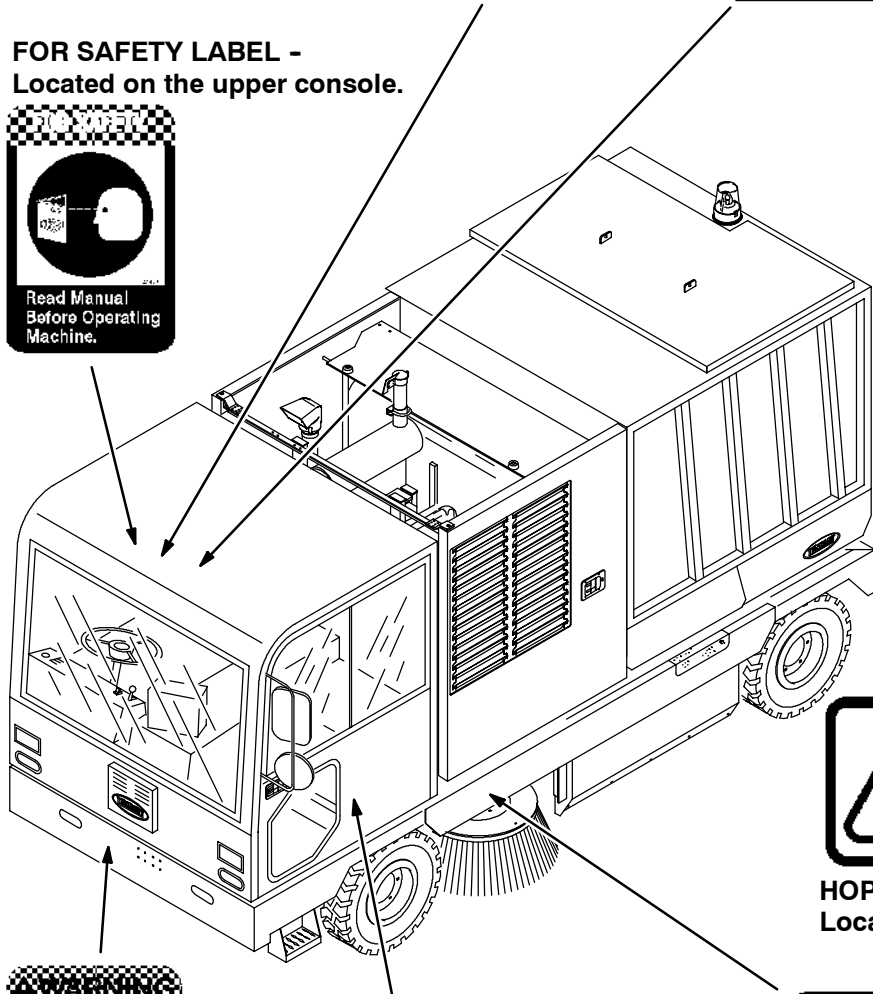

HOPPER DOOR LABEL -
Located below the hopper door.



BRUSH LINKAGE LABEL
(VARIO SWEEPING BRUSH™) -
Located on the front of the machine.



RAISED CAB LABEL -
Located below the cab on the frame.



SIDE BRUSH LABEL -
Located above the side brush(es).

HOPPER SUPPORT PIN LABEL -
Located on both sides of the support pin.
On low dump models, one is located on the upper support cylinder.
On high dump models, one is located on the drivers side of the hopper lift.



FLAMMABLE MATERIALS LABEL (Wet Dust Control Option) -
Located on the drivers side below the water fill spout.



CONVEYOR LABEL -
Located at the back of the conveyor.



VACUUM WAND OPTION NOISE LABEL -
Located on the hopper door.



HOPPER SUPPORT BAR LABEL (High Dump) - Located on both sides of the support bar, on the rear center of the hopper lift, and on both sides of the hopper lift.

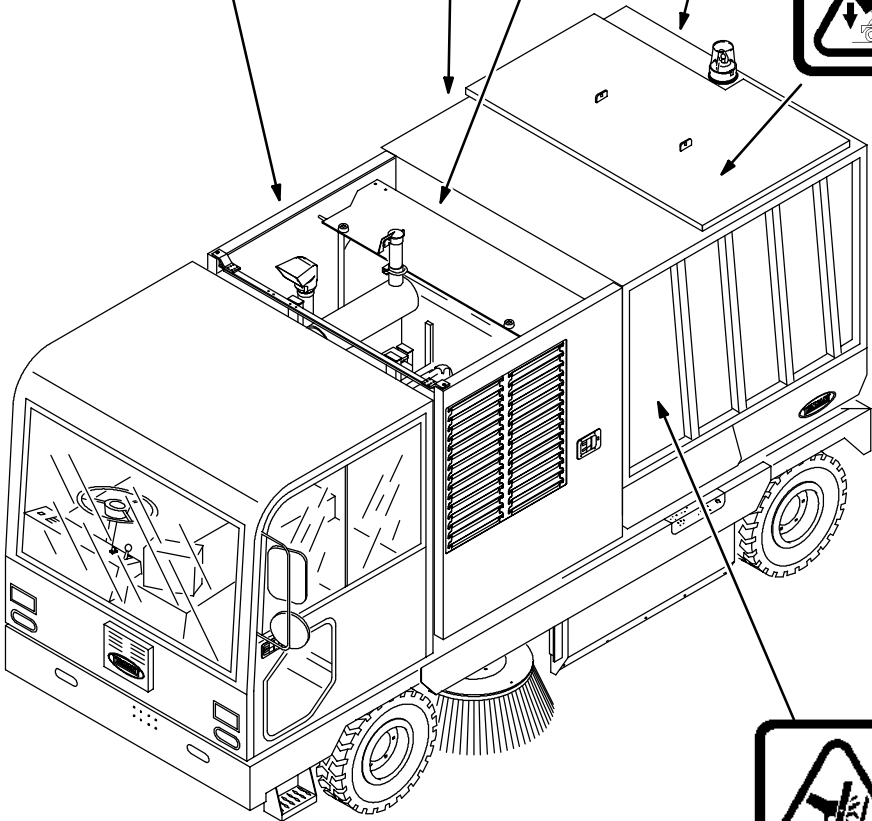

LIFT ARMS LABEL (High Dump) -
Located on the side of the hopper lift.

OPERATOR RESPONSIBILITY

- The operator's responsibility is to take care of the daily maintenance and checkups of the machine to keep it in good working condition. The operator must inform the service mechanic or supervisor when the required maintenance intervals occur as stated in the *MAINTENANCE* section of this manual.
- Read this manual carefully before operating this machine. View the operation video supplied with the machine.

FOR SAFETY: Do not operate machine, unless operation manual is read and understood.

- Check the machine for shipping damage. Check to make sure machine is complete per shipping instructions.
- Keep your machine regularly maintained by following the maintenance information in this manual. We recommend taking advantage of a regularly scheduled service contract from your TENNANT representative.
- Order parts and supplies directly from your authorized TENNANT representative. Use the parts manual provided when ordering parts.
- The model 830-II has a GVWR of 9072 kg (20,000 lb) or 4536 kg (10,000 lb) per axle. Operate only on surfaces capable of supporting this weight.

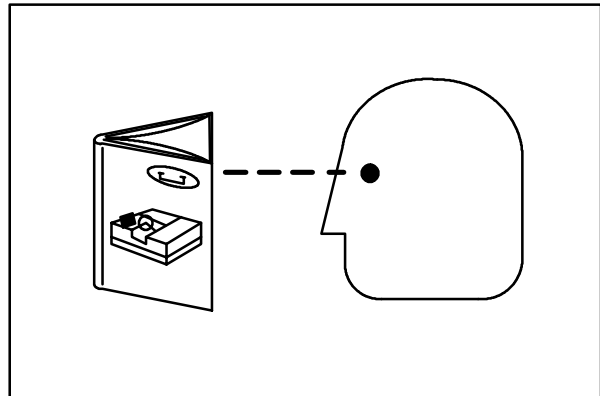

07324

MACHINE COMPONENTS

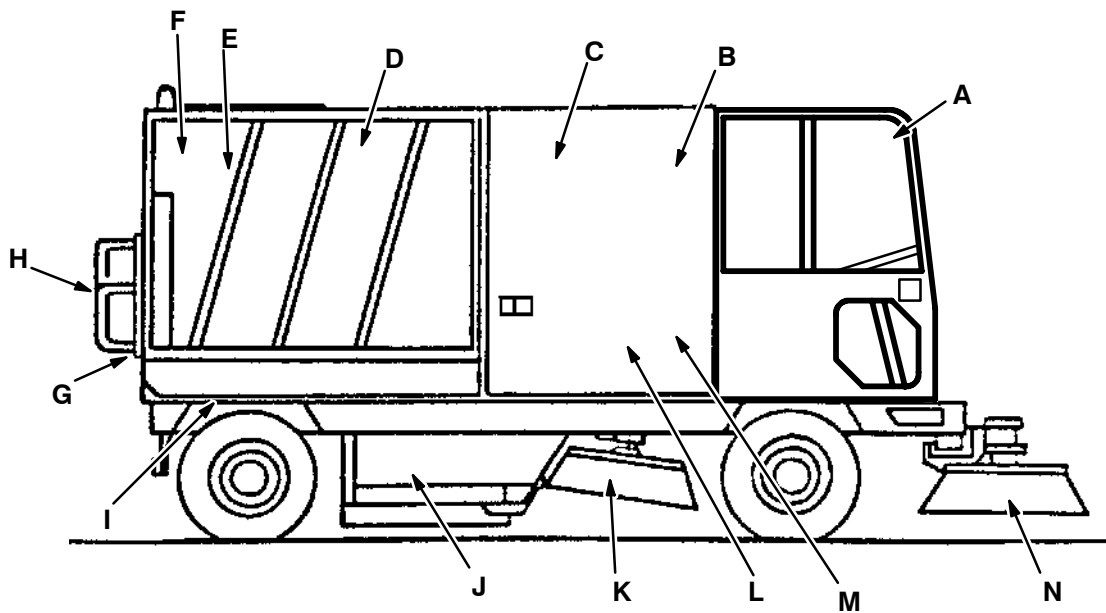

351928

- A. Cab
- B. Diesel Engine
- C. Conveyor
- D. Hopper
- E. Dust Filters
- F. Vacuum Fan
- G. Hopper Door
- H. Vacuum Wand (Option)
- I. Hopper Lift
- J. Main Brush
- K. Side Brush(es)
- L. Water Tank (right side)
- M. Fuel Tank (right side)
- N. Vario Sweeping Brush™ (Option)

OPERATION

CONTROL PANEL SYMBOLS

These symbols identify controls and displays on the machine:



Vario Sweeping Brush™ Up



Vario Sweeping Brush™ Right



Vario Sweeping Brush™ Down



Vario Sweeping Brush™ Left



Vario Sweeping Brush™ Left Side



Vario Sweeping Brush™ Right Side



Vario Sweeping Brush™ Front Tilt Up



Vario Sweeping Brush™ Front Tilt Down



Vario Sweeping Brush™ Side Tilt Left



Vario Sweeping Brush™ Side Tilt Right



Vario Sweeping Brush™ Rotation
Counter-clockwise



Vario Sweeping Brush™
Rotation Clockwise



Forward



Reverse



Fast Engine Speed



Idle Engine Speed



Bright Headlights



Parking Brake



Signal Light



Glow Plug (Preheat)



Clogged Engine Air Cleaner



Water Tank Low



Vacuum Wand Door



Hopper Overload



Heater



Fan



Air Conditioner



Flow Rate



Incline Light



Hopper Door Open



Low Brake Pressure



Hopper Door Close



Engine Shutdown Override



Left Side Brush



Water Spray



Right Side Brush



Left Side Brush



Filter Shaker



Right Side Brush



Conveyor Reverse



Engine Water Temperature



Sweep



Fuel



4-way Warning Lights



Engine Oil Pressure



Hazard Light



Voltmeter



Side Brush Spot Light



Hourmeter



Rear Night Sweeping Light



Brush Down



Front Night Sweeping Light



Hopper Tilt Back



High Pressure Washer



Hopper Tilt Forward



Hopper Lift



Hopper Lower

CONTROLS AND INSTRUMENTS

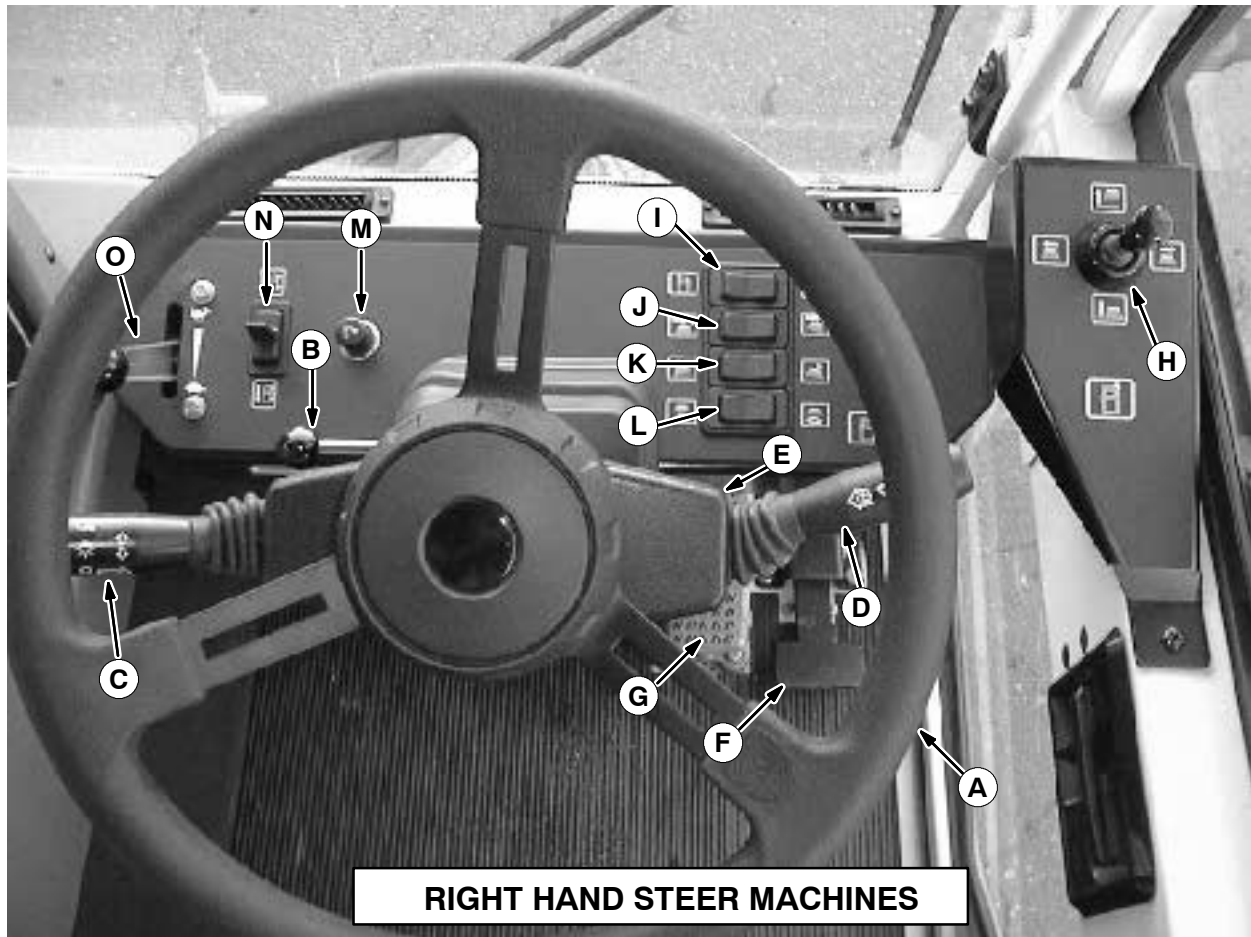

- A. Steering Wheel
- B. Steering Wheel Tilt Lever
- C. Parking Lights, Headlights, Bright Headlights, Signal And Horn Switch
- D. Windshield Wiper And Washer Switch
- E. Ignition Switch
- F. Propelling Pedal
- G. Brake Pedal
- H. Vario Sweeping Brush™ Joystick (Option)
- I. Vario Sweeping Brush™ Swing Switch (Option)
- J. Vario Sweeping Brush™ Front Angle Switch (Option)
- K. Vario Sweeping Brush™ Side Angle Switch (Option)
- L. Vario Sweeping Brush™ On-Off Switch (Option)
- M. Accessory Power Socket
- N. Directional Lever
- O. Throttle Lever

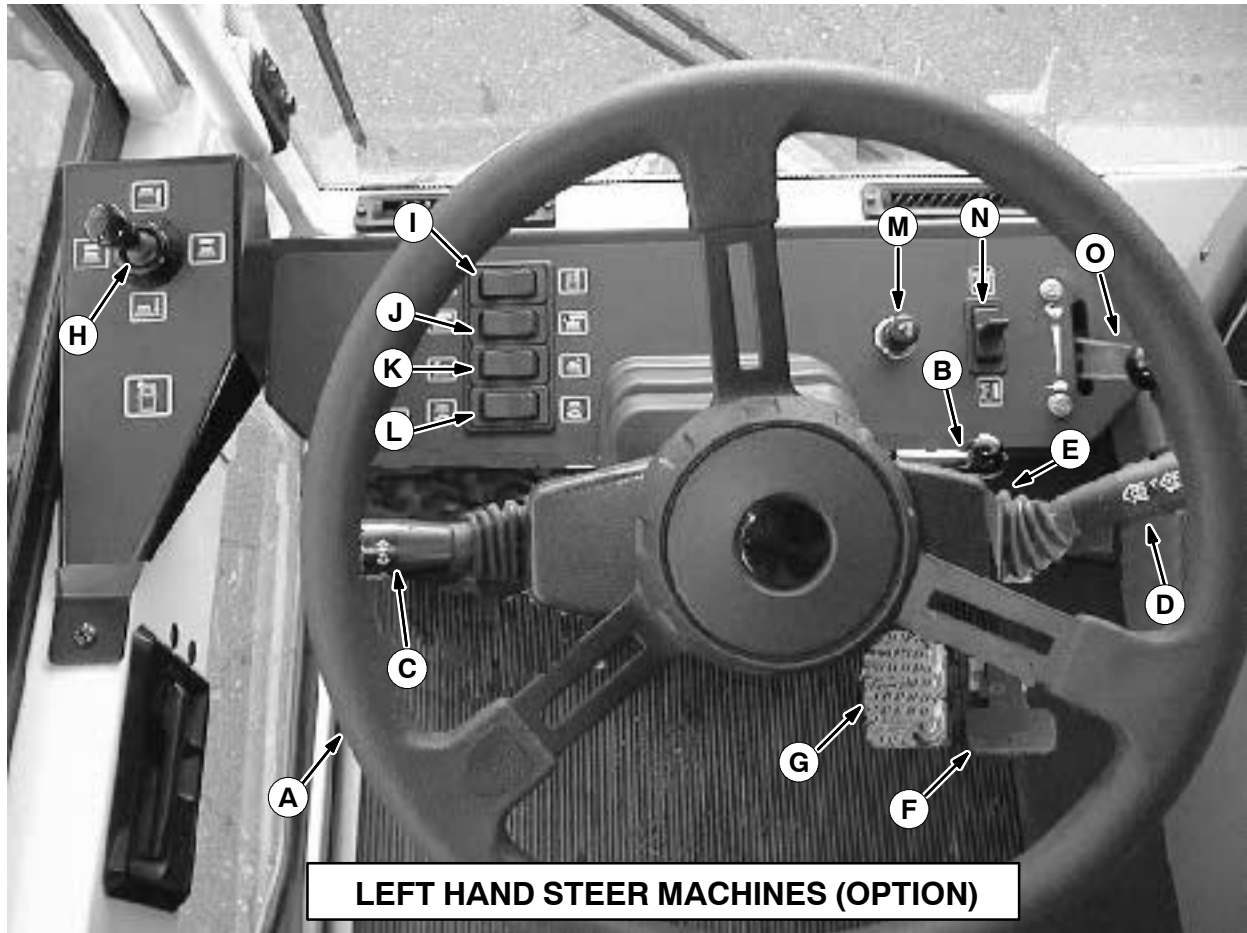

- A. Steering Wheel
- B. Steering Wheel Tilt Lever
- C. Parking Lights, Headlights, Bright Headlights, Signal And Horn Switch
- D. Windshield Wiper And Washer Switch
- E. Ignition Switch
- F. Propelling Pedal
- G. Brake Pedal
- H. Vario Sweeping Brush™ Joystick (Option)
- I. Vario Sweeping Brush™ Swing Switch (Option)
- J. Vario Sweeping Brush™ Front Angle Switch (Option)
- K. Vario Sweeping Brush™ Side Angle Switch (Option)
- L. Vario Sweeping Brush™ On-Off Switch (Option)
- M. Accessory Power Socket
- N. Directional Lever
- O. Throttle Lever

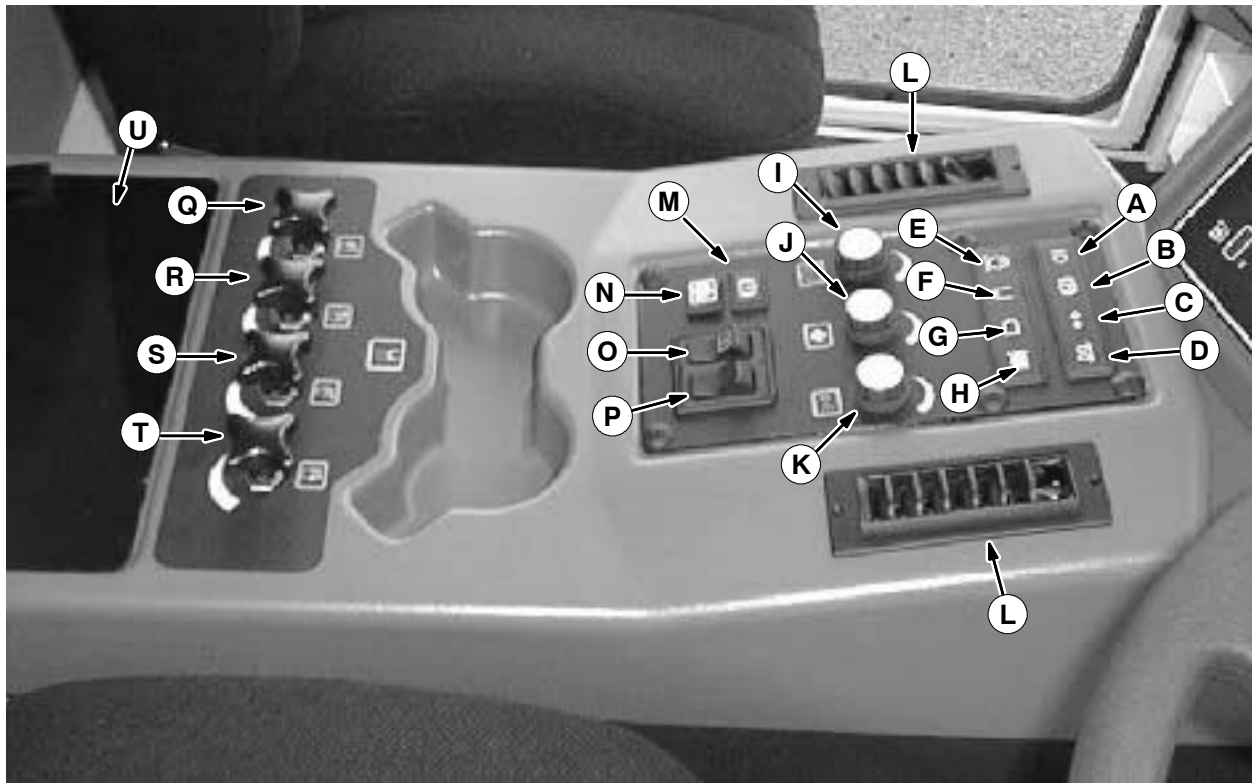

- A. Bright Headlights Light
- B. Parking Brake Light
- C. Signal Light
- D. Glow Plugs Light
- E. Clogged Engine Air Cleaner Light
- F. Water Tank Low Light (Option)
- G. Vacuum Wand Door Light (Option)
- H. Hopper Overload Light
- I. Heater Knob
- J. Fan Knob
- K. Air Conditioner Knob (Option)
- L. Air Circulation Vents
- M. Low Brake Pressure Light
- N. Incline Light (High Dump Model)
- O. Engine Shutdown Override Switch
- P. Parking Brake Switch
- Q. Left Side Brush Water Valve Knob (Option)
- R. Vario Sweeping Brush™ Left Water Valve Knob (Option)
- S. Vario Sweeping Brush™ Right Water Valve Knob (Option)
- T. Right Side Brush Water Valve Knob (Option)
- U. Fuses (Under fuse plate)

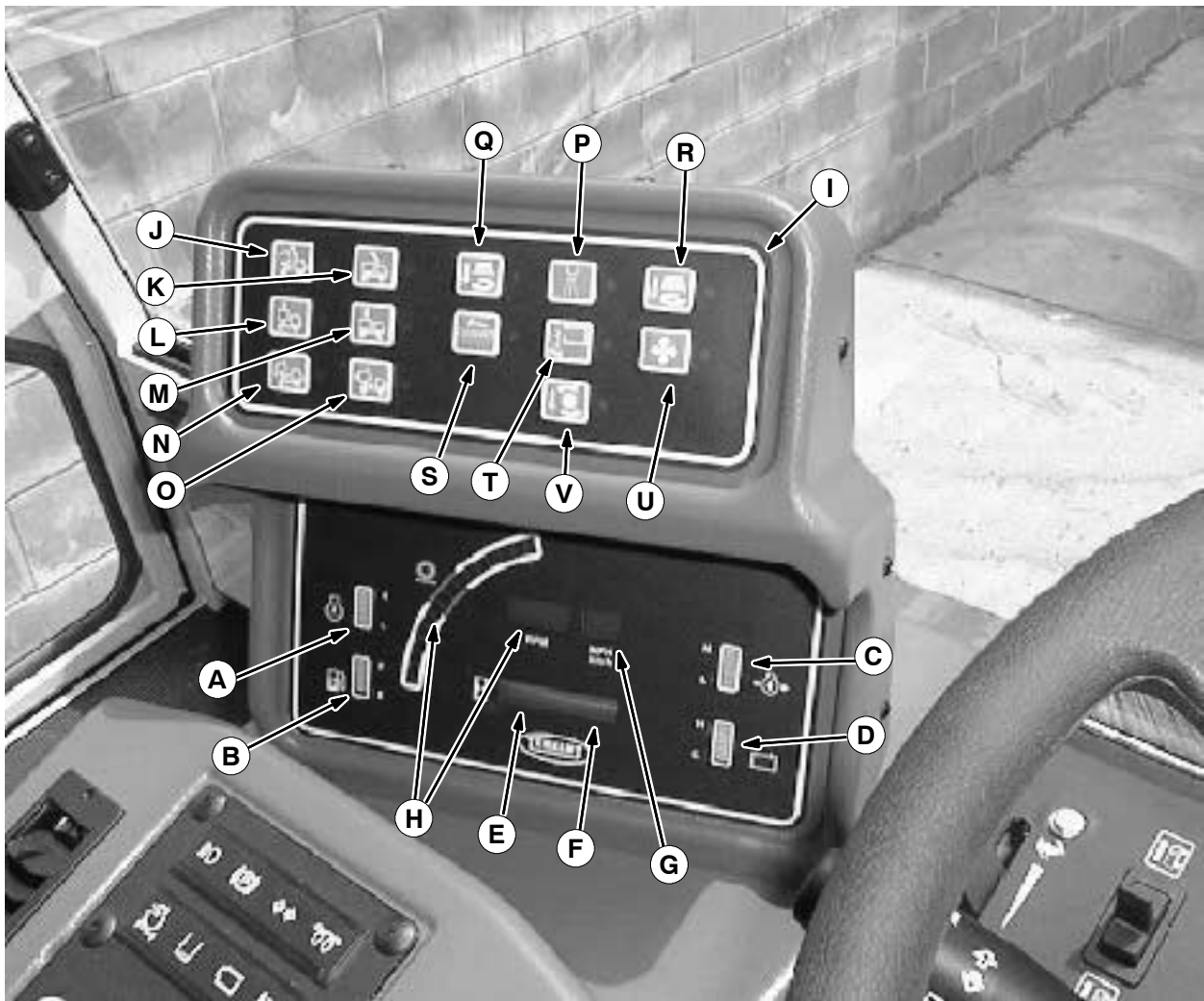

- A. Engine Water Temperature Gauge**
- B. Fuel Level Gauge**
- C. Engine Oil Pressure Gauge**
- D. Voltmeter**
- E. Hourmeter**
- F. Odometer**
- G. Speedometer**
- H. Tachometer**
- I. Switch Panel**
- J. Hopper Tilt Back Switch**
- K. Hopper Tilt Forward Switch**
- L. Hopper Lift Switch (High Dump Model)**
- M. Hopper Lower Switch (High Dump Model)**
- N. Hopper Door Open Switch**
- O. Hopper Door Close Switch**
- P. Water Pump Switch (Option)**
- Q. Left Side Brush Switch**
- R. Right Side Brush Switch**
- S. Filter Shaker Switch**
- T. Conveyor Reverse Switch**
- U. Vacuum Fan Switch**
- V. Sweep Switch**

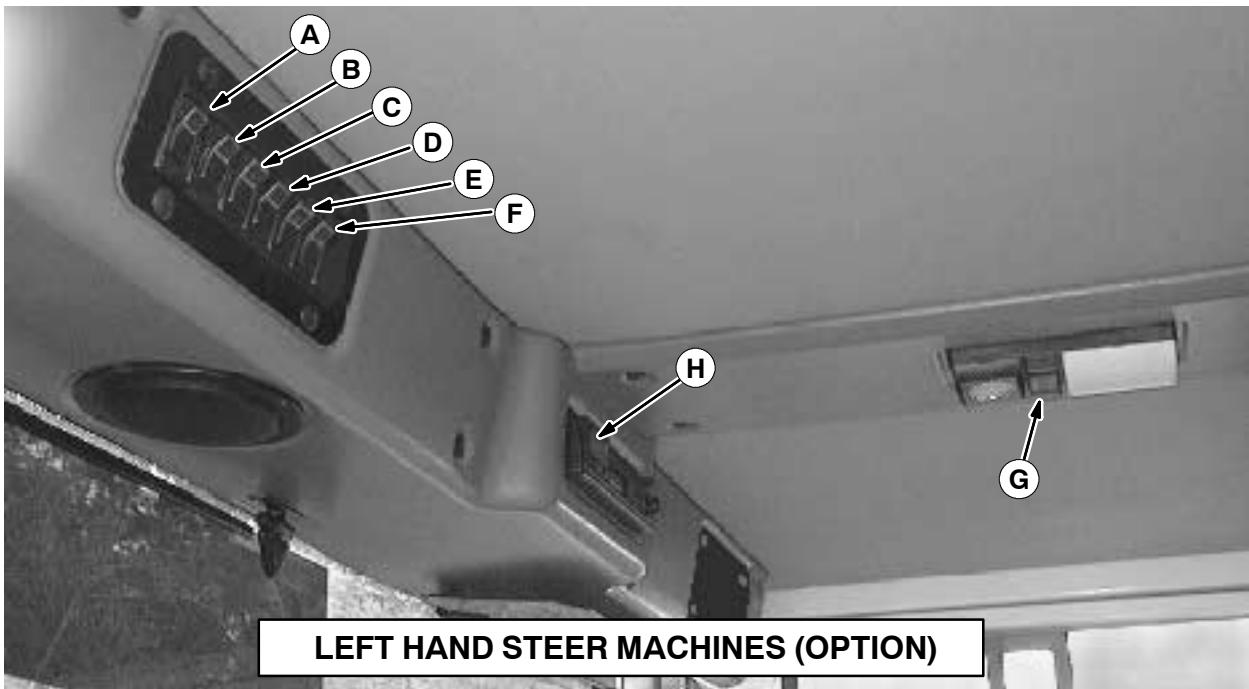
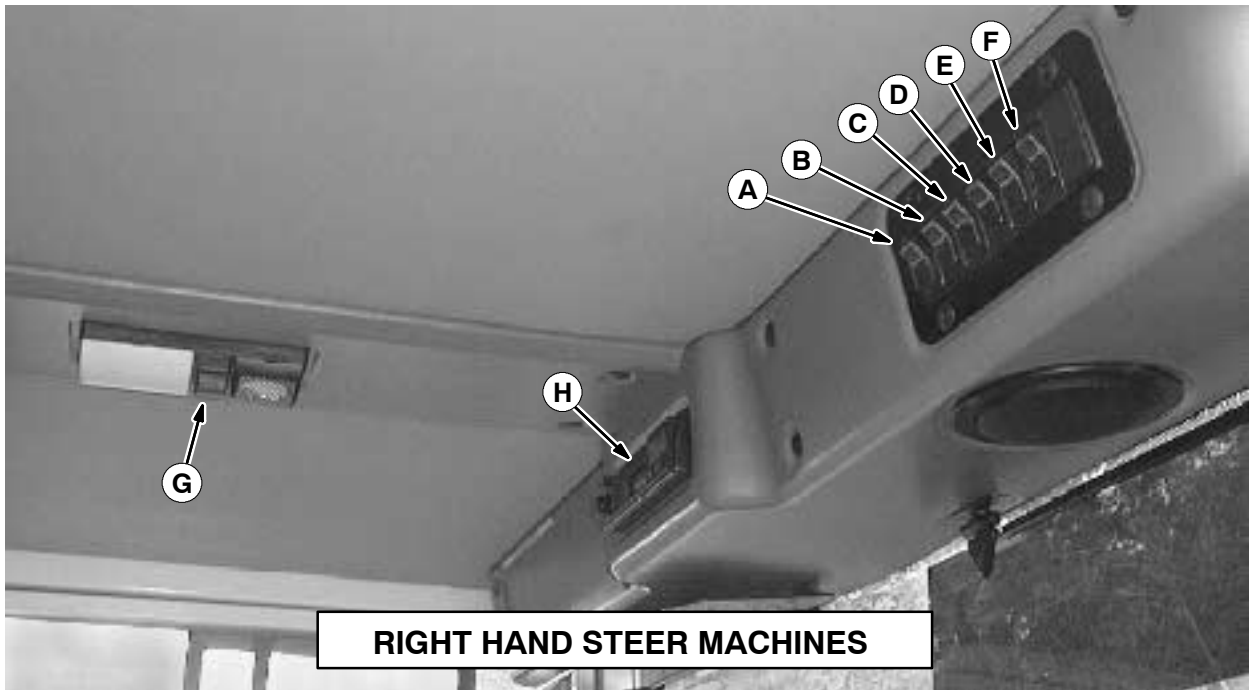

- A. 4-way Warning Lights Switch
- B. Hazard Light Switch
- C. Side Brush Spot Light(s) Switch
- D. Rear Night Sweeping Light Switch (Option)
- E. Front Night Sweeping Light Switch (Option)
- F. High Pressure Washer Switch (Option)
- G. Dome Light And Map Switch
- H. Radio And Cassette Player (Option)

OPERATION OF CONTROLS

OPERATOR SEAT

The *operator seat* has two adjustments. The adjustments are for the front to rear seat position and ride stiffness.

NOTE: The machine will not propel unless the operator is in the seat.

The seat front-to-rear position is adjusted by the seat position lever.

Adjust: Push the lever to the left, slide the seat backward or forward to the desired position and release the lever.



The ride stiffness is adjusted with the stiffness knob.

Adjust: Turn the knob clockwise to increase the ride stiffness, and counter-clockwise to decrease the ride stiffness.

**SEAT BELTS**

The *seat belts* are located on each seat. Always fasten them before operating the machine.



OPERATION

STEERING WHEEL

The *steering wheel* controls the machine's direction. The machine is very responsive to the steering wheel movements.

Left: Turn the steering wheel to the left.

Right: Turn the steering wheel to the right.

NOTE: *The machine has 4-wheel steering. Watch the swing of the rear corners of the machine when turning.*

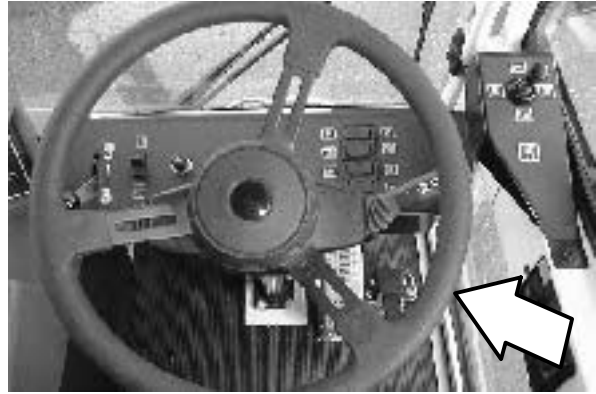

STEERING WHEEL TILT LEVER

The *steering wheel tilt lever* is used to adjust the angle of the steering wheel. To tilt the steering wheel, pull the lever slightly downward and toward the operator seat. Position the steering wheel at the desired position, then release the lever.

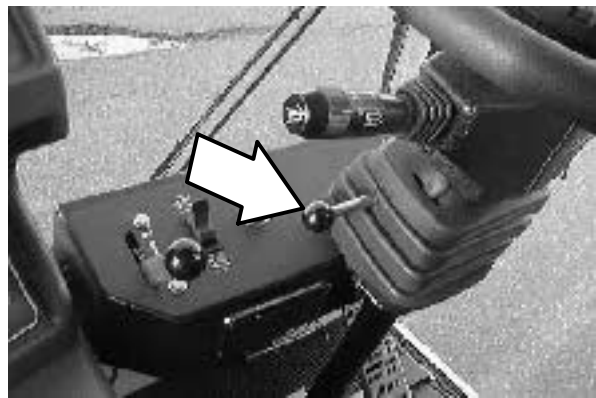

PARKING LIGHTS, HEADLIGHTS, BRIGHT HEADLIGHTS, SIGNAL, AND HORN SWITCH

The *parking lights, headlights, bright headlights, signal, and horn switch* controls the parking lights, headlights, signals, and horn.

Parking and Headlights On: Rotate the switch knob counter-clockwise.

Parking Lights On: Turn the switch knob to the first click.

Headlights On: Turn the switch knob to the second click.

Bright Headlights On: Push the switch lever down.

Bright Headlights Off: Pull the switch lever up.

Flash Bright Headlights: Pull the switch lever up, then release.

Signals: Push the switch lever forward for the right signal. Pull the switch lever back for the left signal.

Horn: Push the switch end towards the steering column.

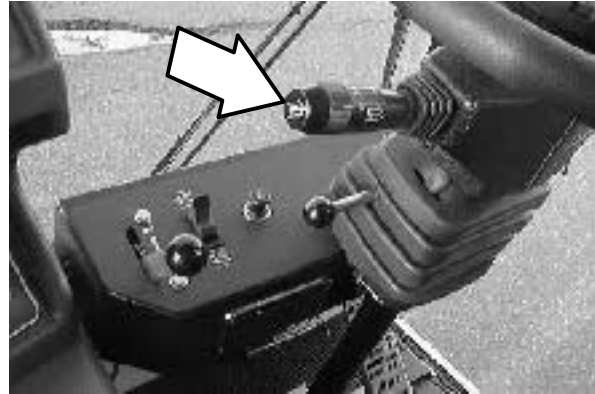

WINDSHIELD WIPER AND WASHER SWITCH

The *windshield wiper and washer switch* controls the windshield wipers and windshield washer fluid spray.

Windshield Wipers Off: Push the lever all the way down.

Windshield Wipers Slow Speed: Pull the switch lever to the first position.

Windshield Wipers Slow Speed: Pull the switch lever to the second position.

Windshield Washer Fluid Spray: Push the switch lever end in.



OPERATION

IGNITION SWITCH

The *ignition switch* starts and stops the engine with a key. When the ignition switch is turned off, the parking brake will come on automatically.

Preheat: Turn the key counter-clockwise. The glow plugs light will come on. When the glow plug light goes out, usually for 5 to 30 seconds depending on the weather conditions, the engine is ready to start.

NOTE: *The preheat is not necessary if the temperature is above 10° C (50° F).*

Start: Turn the key all the way clockwise. Release the key as soon as the engine starts.

Stop: Turn the key counter-clockwise.

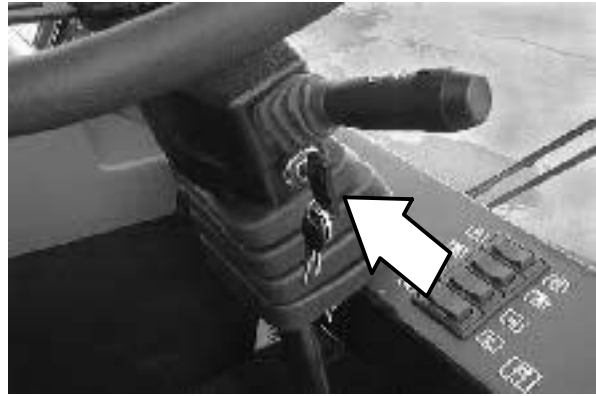

PROPELLING PEDAL

The *propelling pedal* controls the propelling speed of the machine. You change the speed of the machine with the pressure of your foot; the harder you press the pedal, the faster the machine travels. The travel speed is indicated with the speedometer. See the *SPEEDOMETER* section of this manual.

NOTE: *The machine's travel speed is limited to 5 mph when the hopper is tilted or raised.*

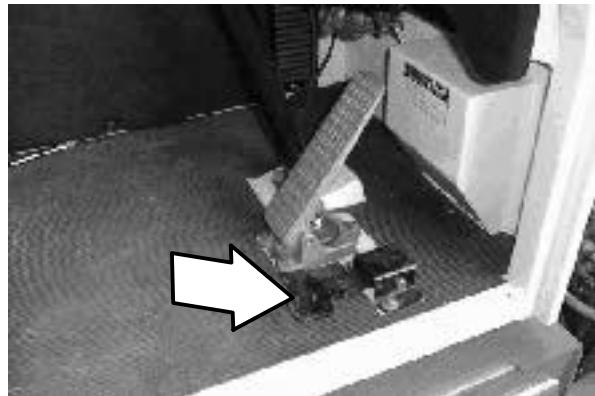

BRAKE PEDAL

The *brake pedal* stops the machine.

NOTE: *The hopper lift and tilt switches will not operate unless the parking brake is set or the service brake is applied.*

Stop: Take your foot off the propelling pedal and step on the brake pedal.



VARIO SWEEPING BRUSH™ LOCK PIN (OPTION)

The *Vario Sweeping Brush™* lock pin keeps the brush arm locked in the storage position during transport of the machine, or when the brush is not being used. Unlock the brush arm before using the *Vario Sweeping Brush™*.

Unlock: Pull out the hair cotter pin out of the end of the lock pin.

Lock: Insert the lock pin and secure with the hair cotter pin.

 **WARNING: Brush linkage pinch points.** Stay clear when linkage is moving.

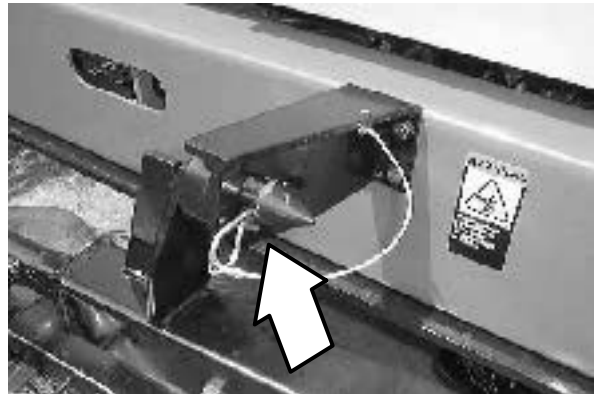

VARIO SWEEPING BRUSH™ JOYSTICK (OPTION)

The *Vario Sweeping Brush™* joystick controls the right-left and up-down movement of the sweeping brush. The sweeping brush arm stays parallel to the front of the machine when using the joystick.

Right: Move and hold the lever to the right into the position until the brush has moved to the desired location.

Left: Move and hold the lever to the left into the position until the brush has moved to the desired location.

Up: Move and hold the lever up into the position until the brush has moved to the desired location.

Down: Move and hold the lever down into the position until the brush has moved to the desired location.



OPERATION

VARIO SWEEPING BRUSH™ SWING SWITCH (OPTION)

The *Vario Sweeping Brush™* swing switch controls the swing of the sweeping brush. This switch will swing the sweeping brush arm by rotating the arm to the left or right.

Left: Press and hold the switch in the position until the brush has moved to the left as far as desired.

Right: Press and hold the switch in the position until the brush has moved to the right as far as desired.



VARIO SWEEPING BRUSH™ FRONT ANGLE SWITCH (OPTION)

The *Vario Sweeping Brush™* front angle switch controls the front angle of the sweeping brush.

Decrease Front Angle: Press and hold the switch in the position.

Increase Front Angle: Press and hold the switch in the position.



VARIO SWEEPING BRUSH™ SIDE ANGLE SWITCH (OPTION)

The *Vario Sweeping Brush™ side angle switch* controls the side angle tilt of the sweeping brush.

Tilt to the Left: Press and hold the switch in the position until the brush is tilted to the angle desired, when operating the brush on the left side of the machine.

Tilt to the Right: Press and hold the switch in the position until the brush is tilted to the angle desired, when operating the brush on the right side of the machine.

**VARIO SWEEPING BRUSH™ ON-OFF SWITCH (OPTION)**

The *Vario Sweeping Brush™ on-off switch* controls the power of the sweeping brush and also determines the direction of brush rotation.

On (right hand sweep): Push the right part of the switch. The brush will turn on and rotate in a counter-clockwise direction.

On (left hand sweep): Push the left part of the switch. The brush will turn on and rotate in a clockwise direction.

Off: Place the switch in the middle position. The brush turn off.



OPERATION

ACCESSORY POWER SOCKET

The *accessory power socket* can be used as a cigarette lighter or as an electrical accessory power outlet.

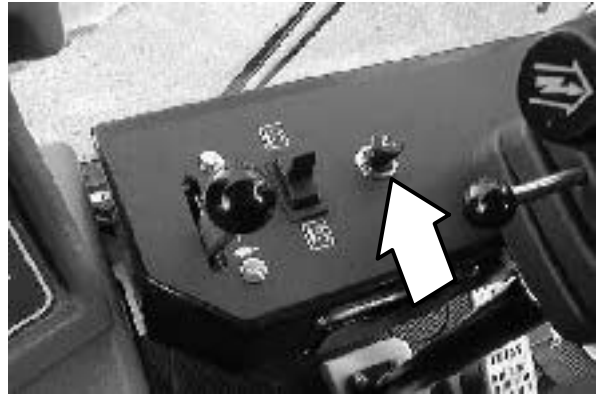

DIRECTIONAL LEVER

The *directional lever* controls the forward-reverse direction of travel of the sweeper.

FOR SAFETY: When starting machine, keep foot on brake and directional lever in neutral.

Forward: Push the lever up into the *Forward* position.

Neutral: Place the lever in the middle, or *Neutral* position.

NOTE: Machine will not start unless the directional lever is in the neutral position. The machine will not propel with the parking brake on.

Reverse: Pull the lever down into the *Reverse* position.



THROTTLE LEVER

The *throttle lever* controls the engine RPM. Move the throttle lever till the tachometer shows the desired engine RPM for transporting or sweeping. See the *TACHOMETER* section of this manual.

Fast: Push the lever forward.

Idle: Pull the lever backward.



BRIGHT HEADLIGHTS LIGHT

The *bright headlights light* comes on when the headlights are on the bright setting.

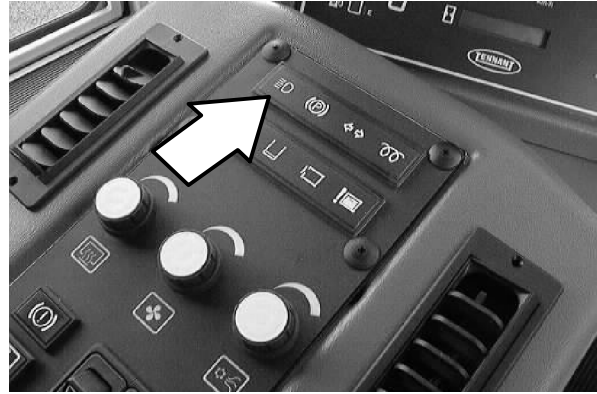
**PARKING BRAKE LIGHT**

The *parking brake light* comes on when the parking brake is set. The light on the parking brake switch will also come on when the parking brake is set. Refer to the *PARKING BRAKE SWITCH* section of this manual.

**SIGNAL LIGHT**

The *signal light* arrows flash when the turn signals are used or when the 4-way warning lights are on.

**GLOW PLUGS LIGHT**

The *glow plugs light* comes on when the ignition switch is turned counter-clockwise to the accessories position. The light will go out when the engine is ready to start, usually 5 to 30 seconds depending on the weather conditions.



OPERATION

CLOGGED ENGINE AIR FILTER LIGHT

The *clogged engine air filter light* comes on when the engine air filter gets clogged. To clean the filter, see *AIR FILTER* in the *MAINTENANCE* section of this manual.

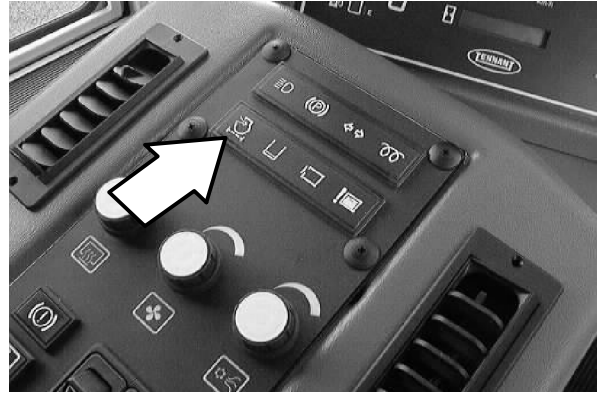

WATER TANK LOW LIGHT (OPTION)

The *water tank low light* comes on when the water tank level is low. The water pump will shut off soon after this light comes on. If the machine is equipped with a high pressure washer option, it's pump will also shut off if this light comes on.

 **WARNING: Flammable materials can cause explosion or fire. Do not use flammable materials in tank. Only use water.**



VACUUM WAND DOOR LIGHT (OPTION)

The *vacuum wand door light* comes on when the vacuum wand door is closed. Make sure the vacuum wand door is open and the vacuum wand door light is off before sweeping with the machine.

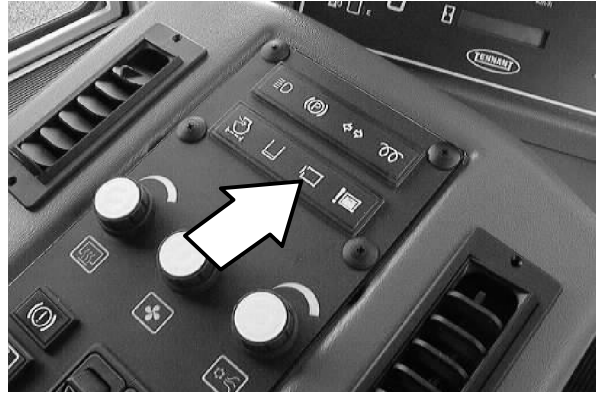
**HOPPER OVERLOAD LIGHT**

The *hopper overload light* comes on when the hopper reached it's weight capacity.

For high dump machines, the hopper light will come on when loaded with more than 1815 kg (4000 lb). When the hopper overload light is on, the hopper can only be tilted to low dump.

For low dump machines, the hopper light will come on when loaded with more than 3175 kg (7000 lb). The hopper should be dumped when the overload light comes on.

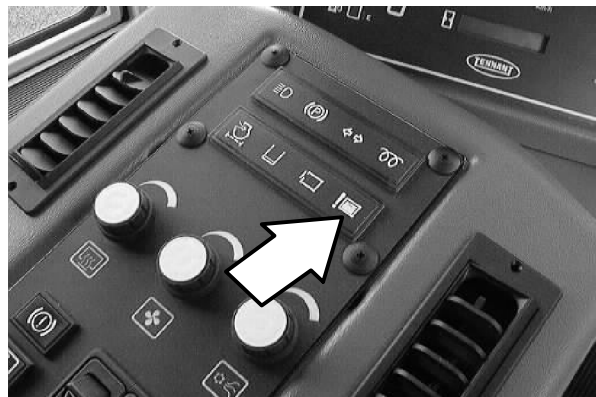

OPERATION

HEATER KNOB

The *heater knob* controls the heater temperature.

Increase: Turn the heater knob clockwise.

Decrease: Turn heater the knob counter-clockwise.

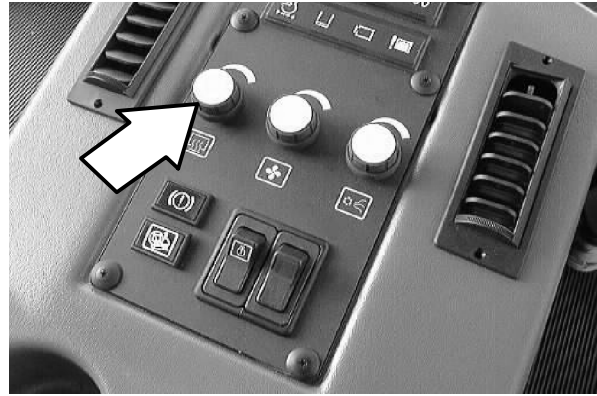

FAN KNOB

The *fan knob* controls the fan speed for the heater and air conditioner.

Increase: Turn the fan knob clockwise.

Decrease: Turn the fan knob counter-clockwise.

NOTE: This switch does not turn off when the ignition is turned off.

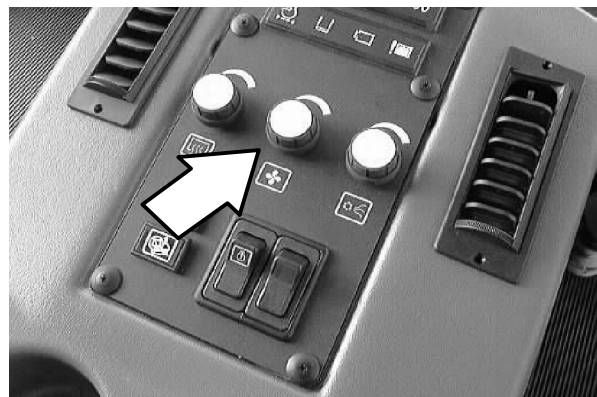

AIR CONDITIONER KNOB (OPTION)

The *air conditioner knob* controls the air conditioner temperature.

Increase The Cool Temperature: Turn the air conditioner knob clockwise.

Decrease The Cool Temperature: Turn air conditioner the knob counter-clockwise.

NOTE: The air conditioner will NOT work unless the fan is turned on.

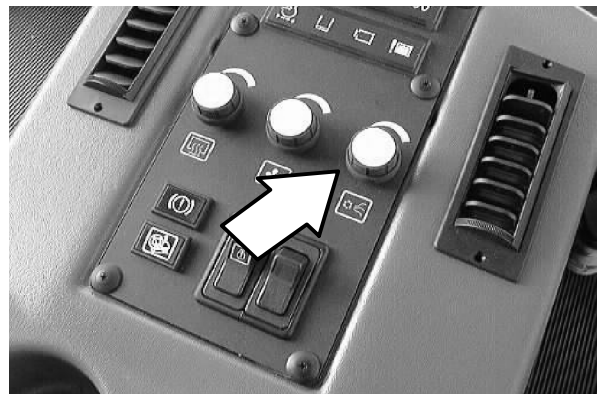

AIR CIRCULATION VENTS

There are numerous *air circulation vents* in the operator cab. There is a set for both the passenger and the driver. If desired, the vents can be closed on the passenger side of the cab for more air flow to the drivers side of the cab. The vents in front of the dash panel are for defrosting.

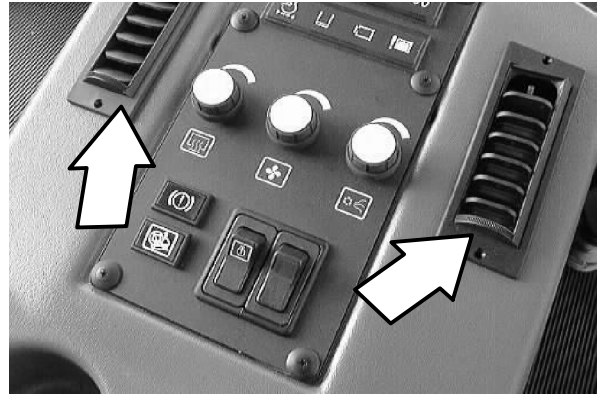

LOW BRAKE PRESSURE LIGHT

The *low brake pressure light* indicates low brake pressure. If this light comes on when the machine is started, do not move the machine until the light goes out. If the light comes on during operation of the machine, proceed with caution out of intersections or traffic and park the machine. If brake pressure drops too low, the parking brake will come on automatically and will not release until brake pressure is restored. Contact your service personnel to restore the brake pressure.

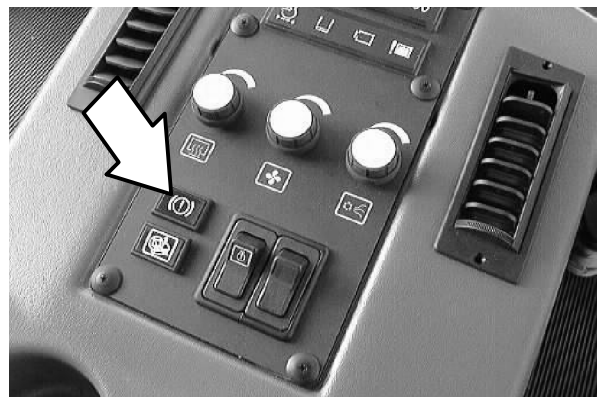

INCLINE LIGHT (High Dump Model)

The *incline light* will come on when the machine is on an incline that is unsafe for high dumping the hopper. It will come on when the front to back incline is more than 8° and the side to side incline is more than 4°. The machine will not high dump when this light is on.

FOR SAFETY: Only dump the hopper on a level surface.

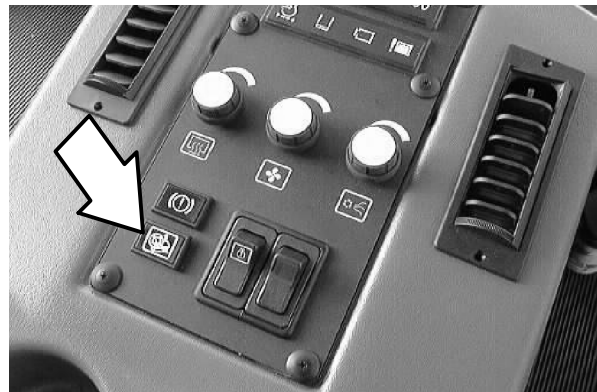

OPERATION

ENGINE SHUTDOWN OVERRIDE SWITCH

The *engine shutdown override switch* will bypass the high water temperature and low oil pressure shutdown feature. Press and hold the switch both to start and operate the machine. This switch is for use if the machine's automatic shutdown feature happens in an intersection or in traffic. Do NOT use this switch for more than a few seconds or damage to the engine could occur. See *ENGINE WATER TEMPERATURE GAUGE* and *ENGINE OIL PRESSURE GAUGE* sections of this manual.

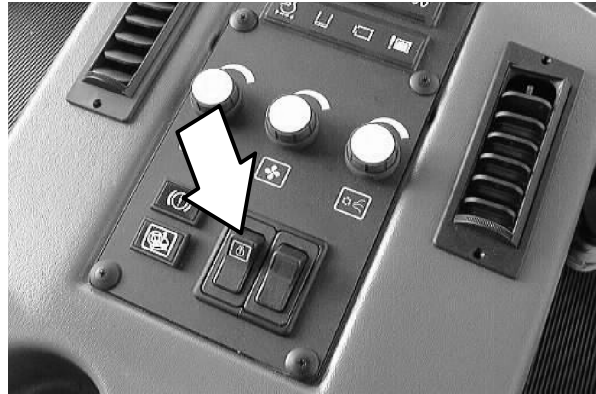

PARKING BRAKE SWITCH

The *parking brake switch* sets and releases the front wheel brakes as well as disables the propelling system. When the ignition switch is turned off, the parking brake will come on automatically.

NOTE: The hopper lift and tilt switches will not operate unless the parking brake is set or the service brake is applied.

NOTE: The high pressure washer option will not operate unless the parking brake is set.

Set: Press the top part of the parking brake switch. The indicator light in the switch as well as the parking brake light will come on.

FOR SAFETY: Before leaving or servicing machine, stop on level surface, set parking brake, turn off machine and remove key.

Release: Press the bottom part of the parking brake switch. The indicator light in the switch as well as the parking brake light will turn off.

NOTE: If brake pressure drops too low, the parking brake will come on automatically and will not release until brake pressure is restored. When this happens, this switch will NOT indicate that it is set. See LOW BRAKE PRESSURE LIGHT section of this manual.

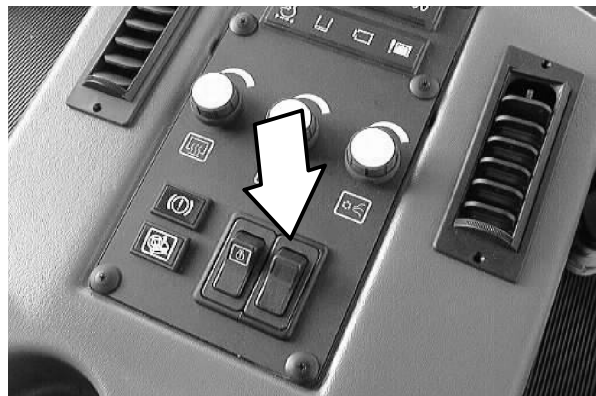

LEFT SIDE BRUSH WATER VALVE KNOB (OPTION)

The *left side brush water valve knob* controls the amount of water spray to the left side brush.

Increase Water Spray: Turn the left side brush water valve knob counter-clockwise.

Decrease Water Spray: Turn the left side brush water valve knob clockwise.

Stop Water Spray: Turn the water valve knob clockwise until it comes to a complete stop to close the water supply. If this is NOT done when the machine is shut off, water will continue to flow.

NOTE: The water pump switch needs to be on for the water valves to operate.

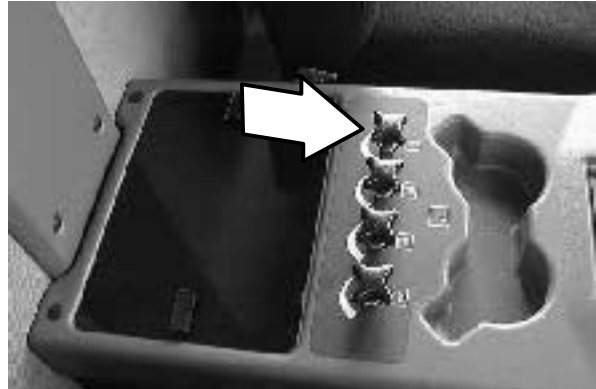

VARIO SWEEPING BRUSH™ LEFT WATER VALVE KNOB (OPTION)

The *Vario Sweeping Brush™ left water valve knob* controls the amount of water spray to the sweeping brush when it is on left side of the machine.

Increase Water Spray: Turn the water valve knob counter-clockwise.

Decrease Water Spray: Turn the water valve knob clockwise.

Stop Water Spray: Turn the water valve knob clockwise until it comes to a complete stop to close the water supply. If this is NOT done when the machine is shut off, water will continue to flow.

NOTE: The water pump switch needs to be on for the water valves to operate.

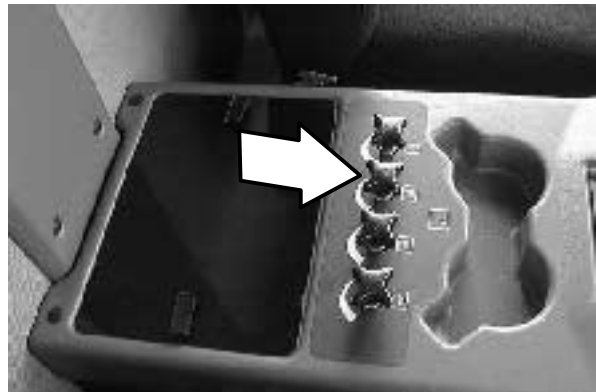

OPERATION

VARIO SWEEPING BRUSH™ RIGHT WATER VALVE KNOB (OPTION)

The *Vario Sweeping Brush™* right water valve knob controls the amount of water spray to the sweeping brush when the it is on the right side of the machine.

Increase Water Spray: Turn the water valve knob counter-clockwise.

Decrease Water Spray: Turn the water valve knob clockwise.

Stop Water Spray: Turn the water valve knob clockwise until it comes to a complete stop to close the water supply. If this is NOT done when the machine is shut off, water will continue to flow.

NOTE: The water pump switch needs to be on for the water valves to operate.

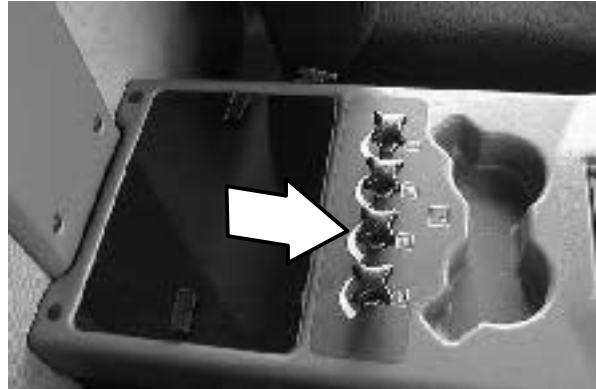

RIGHT SIDE BRUSH WATER VALVE KNOB (OPTION)

The *right side brush water valve knob* controls the amount of water spray to the right side brush.

Increase Water Spray: Turn the right side brush water valve knob counter-clockwise.

Decrease Water Spray: Turn the right side brush water valve knob clockwise.

Stop Water Spray: Turn the water valve knob clockwise until it comes to a complete stop to close the water supply. If this is NOT done when the machine is shut off, water will continue to flow.

NOTE: The water pump switch needs to be on for the water valves to operate.

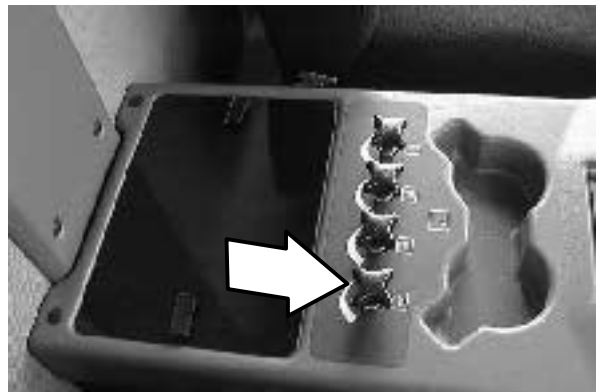

FUSES

Fuses are a one-time protection device designed to stop the flow of current in the event of a circuit overload. This machine uses automotive ATO type fuses. **Never substitute higher value fuses than specified.**

The fuses are located in the fuse box under the fuse plate of the center console.

Fuse	Rating	Circuit Protected
FU-1	30 A	Accessory
FU-2	30 A	Preheat
FU-3	25 A	Turn Signals
FU-4	15 A	Night Lights
FU-5	15 A	Rotating / Sidebrush
FU-6	15 A	Headlight
FU-7	15 A	Taillight / Marker
FU-8	15 A	Water Pump
FU-9	15 A	Accessory Power Socket
FU-10	10 A	Horn
FU-11	10 A	Domelight / Radio
FU-12		Open
FU-13		Open
FU-14		Open
FU-15	25 A	Heater / air conditioner
FU-16	15 A	Logic Power
FU-17	15 A	Hopper Control
FU-18	10 A	Logic
FU-19	10 A	Sensors
FU-20		Open
FU-21		Open
FU-22		Open
FU-23		Open
FU-24	10 A	Vario front brush
FU-25	10 A	Radio
FU-26	10 A	Wipers
FU-27	15 A	Neutral Start Propel
FU-28	15 A	Daytime Running Lights

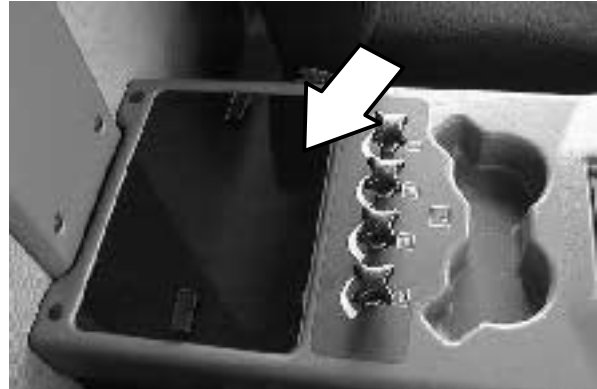

OPERATION

ENGINE WATER TEMPERATURE GAUGE

The *engine water temperature gauge* shows the engine coolant temperature. If the engine coolant temperature is too hot, the LED indicator light will blink. If this happens, stop the engine, locate the problem and have it corrected. If the engine is not turned off, the machine is equipped with an automatic shutdown feature that will turn off the engine. This keeps the engine from being damaged. To override this automatic shutdown, refer to the *ENGINE SHUTDOWN OVERRIDE SWITCH* section of this manual.

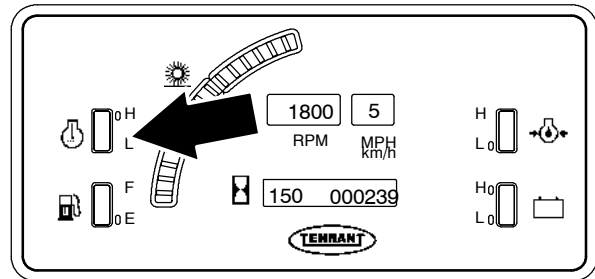

351927

FUEL LEVEL GAUGE

The *fuel level gauge* indicates how much fuel is in the fuel tank. The LED indicator light will blink when the fuel level is low.

NOTE: Do not let the fuel tank empty completely. Air can enter the fuel system and require bleeding, before the next engine start.

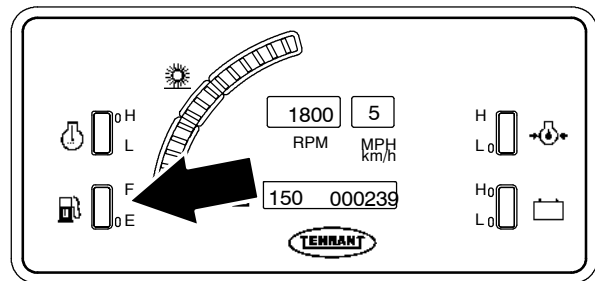

351927

ENGINE OIL PRESSURE GAUGE

The *engine oil pressure gauge* displays the engine oil pressure. If the oil pressure falls too low, the LED light will blink. If this happens, stop the engine, locate the problem and have it corrected. If the engine is not turned off, the machine is equipped with an automatic shutdown feature that will turn off the engine. This keeps the engine from being damaged. To override this automatic shutdown, refer to the *ENGINE SHUTDOWN OVERRIDE SWITCH* section of this manual.

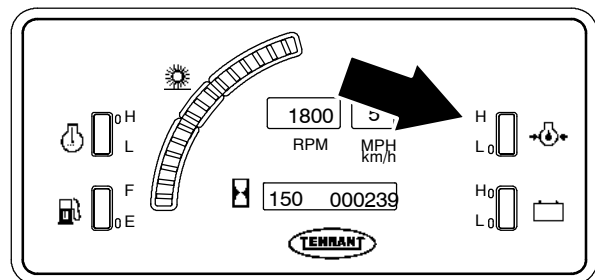

351927

VOLTMETER

The *voltmeter* displays the existing voltage of the battery. When the voltage is not within the normal range - 12 to 14 Volts, the LED light will blink. If this happens, stop operating the machine, locate the problem and have it corrected.

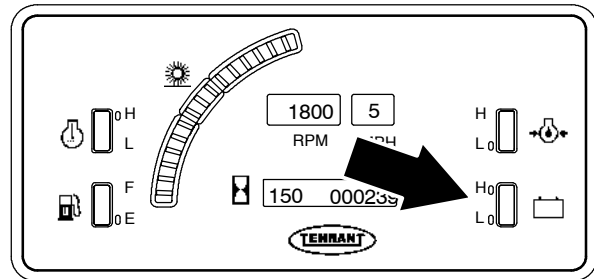

351927

HOURLMETER

The *hourmeter* records the number of hours the machine has been operated. Use this information to determine machine maintenance intervals.

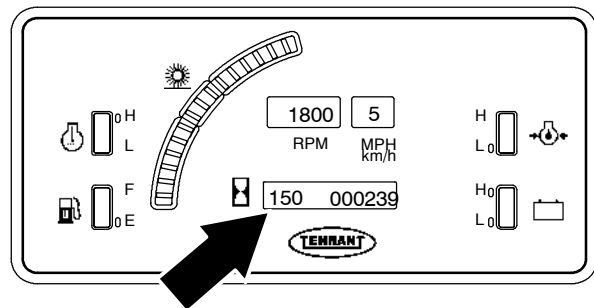

351927

ODOMETER

The *odometer* records the distance that the machine has been driven. Use this information to determine machine maintenance intervals such as tire wear.

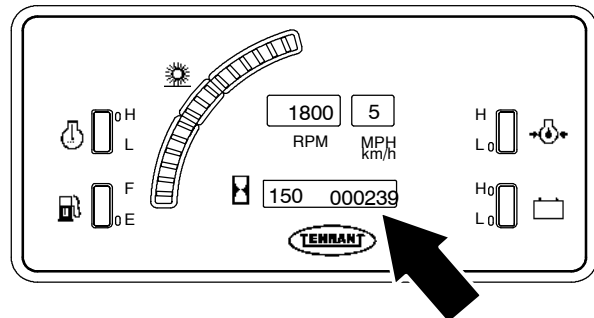

351927

SPEEDOMETER

The *speedometer* displays the machines travel speed. Use this for determining the proper operating speed for sweeping and transporting.

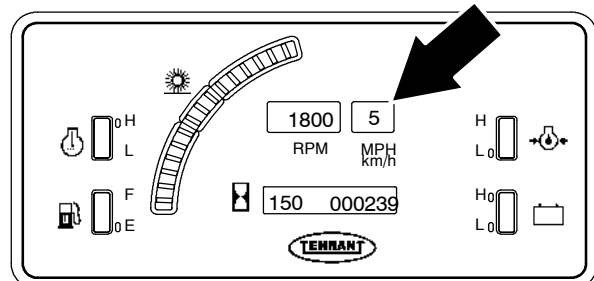

351927

OPERATION

TACHOMETER

The *tachometer* consists of a numeric display, an LED visual display, and a green *SWEEP* light. The numeric display shows the engine RPM. Move the throttle lever till the tachometer shows the desired engine RPM for transporting or sweeping. See the *THROTTLE LEVER* section of this manual.

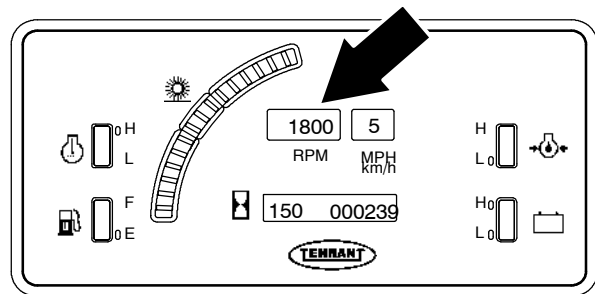

351927

The tachometer's LED visual display indicates when the engine RPM is set for proper sweeping. When the amber LED light is in the middle of the gauge (between the blue markings), the engine throttle is at a proper setting for sweeping. The desired sweeping speed is between 1600 and 2000 RPM. Refer to the chart in the *SWEEPING* section.

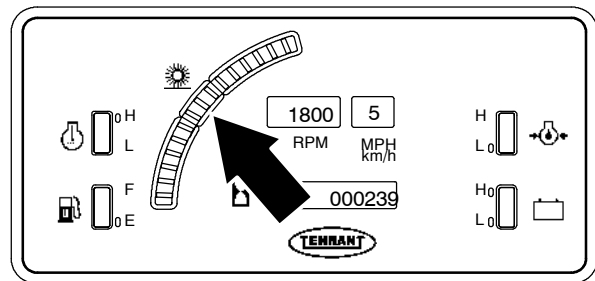

351927

The tachometer's green *SWEEP* light will illuminate when the engine RPM is set for proper sweeping. If the engine speed is operating below 1600 RPM, the green *SWEEP* light will turn off while the sweeping functions will continue to operate. If the engine speed is operating too fast for sweeping (above 2000 RPM), the green *SWEEP* light will blink and an audio alarm will sound. This will continue for 15 seconds, then the sweeping functions will stop and raise.

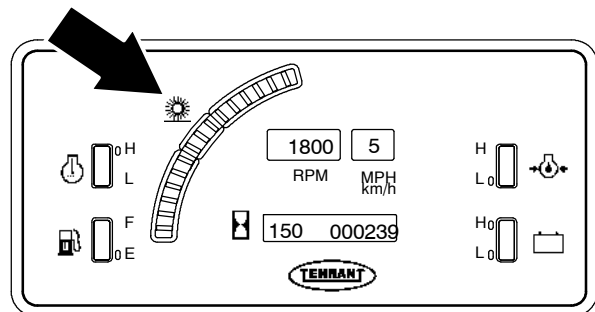

351927

SWITCH PANEL

The *switch panel* contains the switches that control the hopper and sweeping functions. It is located on the front center part of the cab.

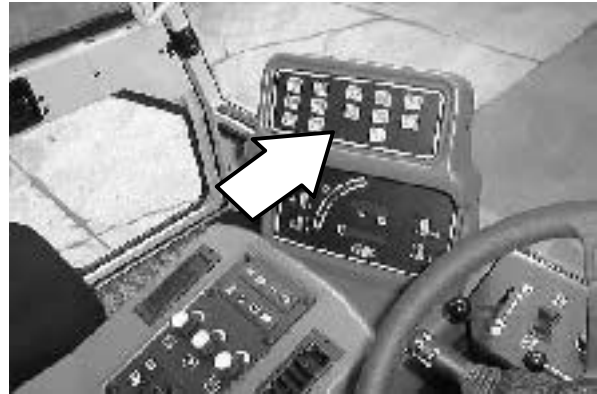

HOPPER TILT BACK SWITCH

The *hopper tilt back switch* tilts the hopper back for dumping debris. It will also stop and raise the sweeping functions. The machine's travel speed is limited to 5 mph when the hopper is tilted.

NOTE: The hopper lift and tilt switches will not operate unless the parking brake is set or the service brake is applied.

Press and hold the switch until the hopper is in the desired tilted position, then release the switch. An audio alarm will sound when the hopper is moving. The hopper tilt will automatically stop when it is fully tilted. The light next to the switch will come on while the hopper is being tilted. This light will flash when the switch is released and the hopper is in a tilted position.

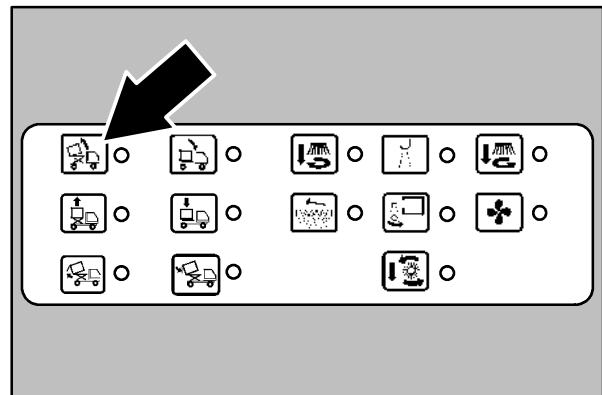

351926

⚠ WARNING: Lift arm pinch point. Stay clear of hopper lift arms.

HOPPER TILT FORWARD SWITCH

The *hopper tilt forward switch* tilts the hopper forward after dumping debris. Press and hold the switch until the hopper is fully forward. An audio alarm will sound when the hopper is moving. The light next to the switch will come on only while the switch is being pressed. The hopper is fully forward when the *hopper tilt back switch* light stops flashing.

NOTE: The hopper lift and tilt switches will not operate unless the parking brake is set or the service brake is applied.

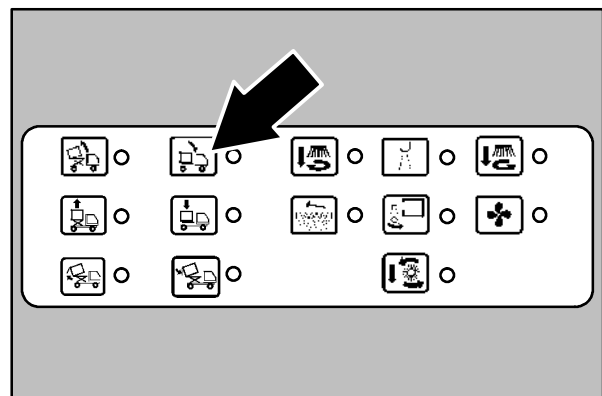

351926

⚠ WARNING: Lift arm pinch point. Stay clear of hopper lift arms.

OPERATION

HOPPER LIFT SWITCH (High Dump Model)

The *hopper lift switch* will raise the hopper for high dumping. It will also stop and raise the sweeping functions. The machine's travel speed is limited to 5 mph when the hopper is raised.

NOTE: The hopper lift and tilt switches will not operate unless the parking brake is set or the service brake is applied.

 **WARNING: High dump vertical clearance. Stay clear of overhead obstructions and power lines.**

Press and hold the switch until the hopper is at the desired raised position, then release the switch. An audio alarm will sound when the hopper is moving. The hopper lift will automatically stop when it is fully raised. The light next to the switch will come on while the hopper is being raised. This light will flash when the switch is released with the hopper in a raised position.

NOTE: The hopper will not lift if the optional hopper incline or overload light is on. This indicates that the machine is either on an incline that is unsafe or that the hopper is too heavy for high dumping the hopper.

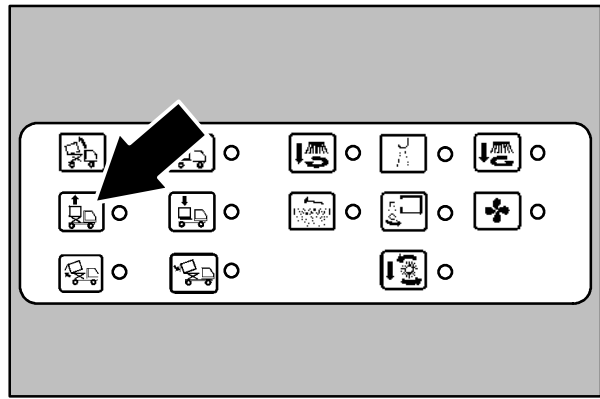

351926

HOPPER LOWER SWITCH (High Dump Model)

The *hopper lower switch* lowers the hopper after high dumping. Press and hold the switch until the hopper is fully lowered. An audio alarm will sound when the hopper is moving. The light next to the switch will come on only while the switch is being pressed. The hopper is fully lowered when the *hopper lift switch* light stops flashing.

NOTE: The hopper lift and tilt switches will not operate unless the parking brake is set or the service brake is applied.

 **WARNING: Lift arm pinch point. Stay clear of hopper lift arms.**

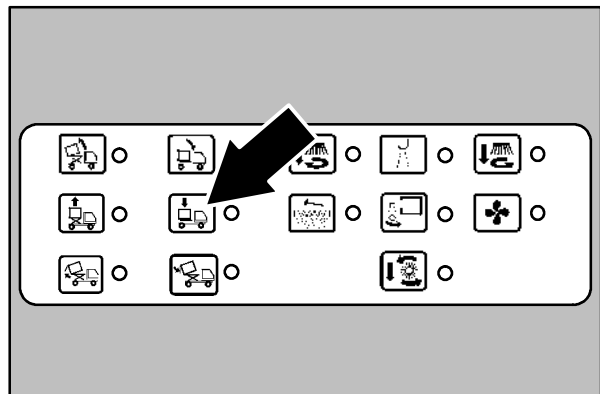

351926

HOPPER DOOR OPEN SWITCH

The *hopper door open switch* unlatches the hopper door. With the hopper tilted, press and hold the switch for 2–3 seconds. The hopper door will unlatch and open. The light next to the switch will flash when the hopper door is unlatched.

 **WARNING: Hopper door pinch point.**
Stay clear of hopper door.

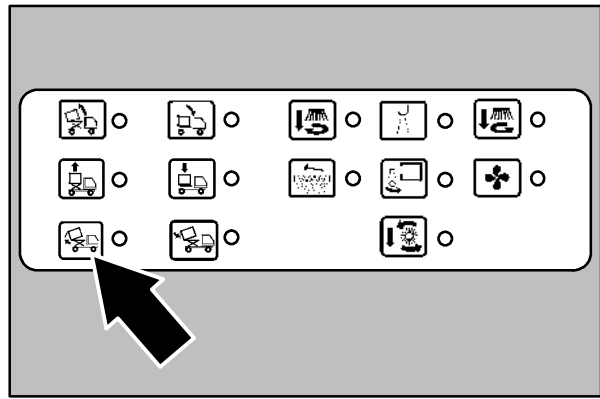

351926

HOPPER DOOR CLOSE SWITCH

The *hopper door close switch* latches the hopper door. With the hopper fully lowered, press and hold the switch for 2–3 seconds. The hopper must be fully lowered for the door to latch. The light next to the switch will come on only while the switch is being pressed. The door is latched when the *hopper door open switch* light stops flashing.

 **WARNING: Hopper door pinch point.**
Stay clear of hopper door.

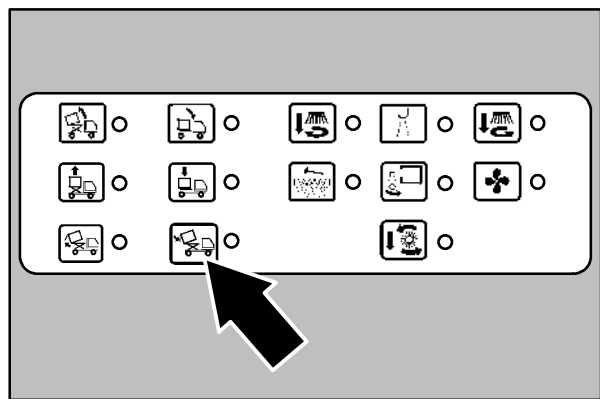

351926

WATER PUMP SWITCH (OPTION)

The *water pump switch* controls the water pump for the wet dust control system. Press the switch to activate the water pump. The light next to the switch will come on. To turn off the water pump, press the switch again. The light will turn off.

The water pump will shut off automatically when the *water tank low light* comes on.

NOTE: The water valve knobs must be turned open for the wet dust control system to work.

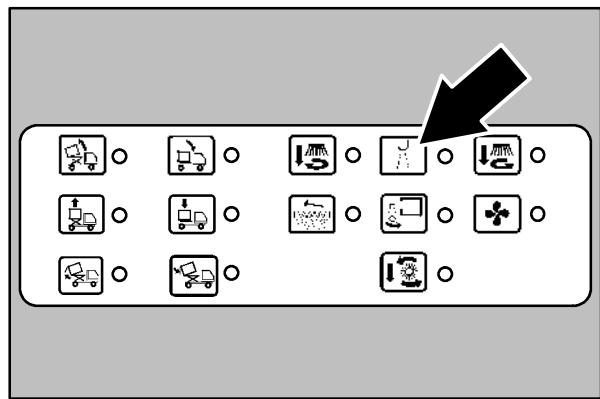

351926

OPERATION

LEFT SIDE BRUSH SWITCH (OPTION)

The *left side brush switch* controls the left side brush. Press the switch to lower and turn on the left side brush. The light next to the switch will come on. To lift and turn off the left side brush, press the switch again. The light will turn off.

NOTE: The side brushes will automatically turn on with the SWEEP SWITCH **IF** they were in the “on” position when the sweep switch was last turned off.

 **WARNING:** Side brush can move. Do not step on side brush.

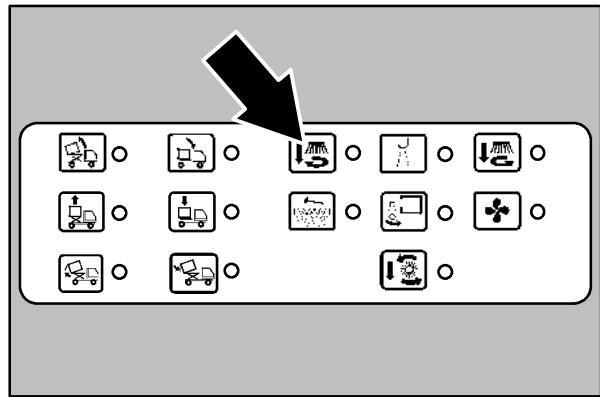

351926

RIGHT SIDE BRUSH SWITCH

The *right side brush switch* controls the right side brush. Press the switch to lower and turn on the right side brush. The light next to the switch will come on. To lift and turn off the right side brush, press the switch again. The light will turn off.

NOTE: The side brushes will automatically turn on with the SWEEP SWITCH **IF** they were in the “on” position when the sweep switch was last turned off.

 **WARNING:** Side brush can move. Do not step on side brush.

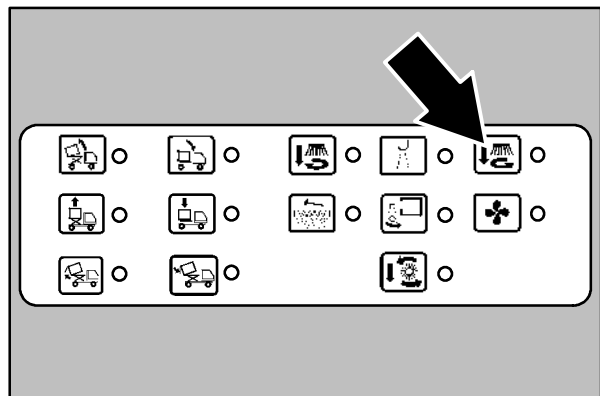

351926

FILTER SHAKER SWITCH

The *filter shaker switch* controls the hopper dust filter shaker system. It is used to shake clean the dust from the filter. With the throttle in the idle position, press and hold the switch for 1 to 2 seconds to activate the system. The light next to the switch will come on while the filter is shaking. The filter will shake for about 30 seconds, then it will stop and the light will turn off.

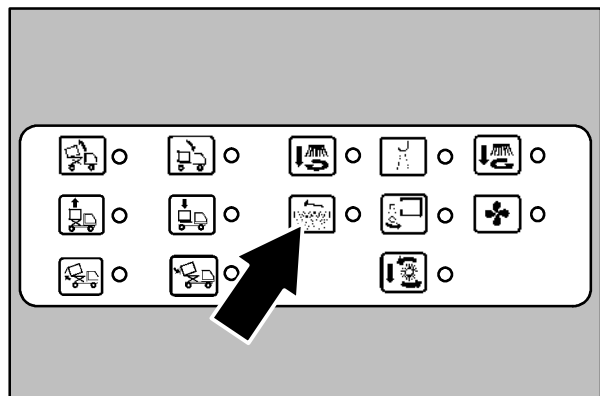

351926

CONVEYOR REVERSE SWITCH

The *conveyor reverse switch* controls the direction of the debris conveyor. The reverse direction is used for unjamming debris clogged in the conveyor and also for cleaning the conveyor. Press the switch to reverse the direction of the conveyor. The light next to the switch will come on. To return the conveyor to the forward sweeping direction, press the switch again. The light will turn off.

NOTE: Do NOT leave the conveyor reverse switch in the reverse position for sweeping.

WARNING: Conveyor throws debris. Conveyor pinch point. Stay clear when in operation.

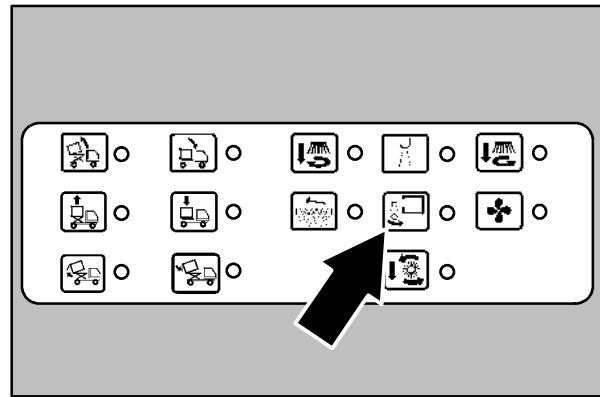

351926

VACUUM FAN SWITCH

The *vacuum fan switch* controls the vacuum fan. This switch will come on automatically when the *sweep switch* is activated. It can be controlled separately without the other sweeping functions. It can be turned on separately for things like the vacuum wand or it can be turned off separately for things like sweeping in rainy conditions. Press the switch to turn on the vacuum fan. The light next to the switch will come on. Press the switch again to turn the vacuum fan off. The light will turn off.

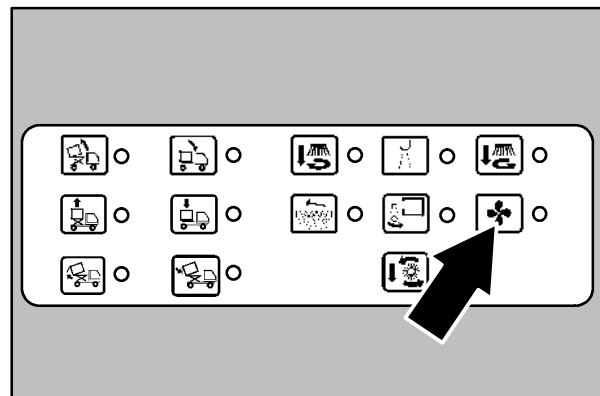

351926

OPERATION

SWEEP SWITCH

The *sweep switch* controls the sweeping functions of the machine. These functions include the vacuum fan, the main brush, the conveyor, and side brushes. They do **NOT** control the Vario brush.

NOTE: The sweep switch can NOT be activated if any of the hopper control switches are lit. The hopper must be in the fully forward and lowered position with the hopper door latched before sweeping.

To start the sweeping functions, press the *sweep switch*. The vacuum fan will come on, the main brush and conveyor will lower and will also come on. The lights next to these switches will come on. The side brushes will also automatically turn on with the *sweep switch* **IF** they were in the *on* position when the sweep switch was last turned off.

NOTE: If the engine speed is operating too fast for sweeping, the sweeping functions will lift and turn off after 15 seconds. See the TACHOMETER section of this manual.

To stop and raise the sweeping functions, press the *sweep switch* again. The lights next to these sweeping function switches will turn off.

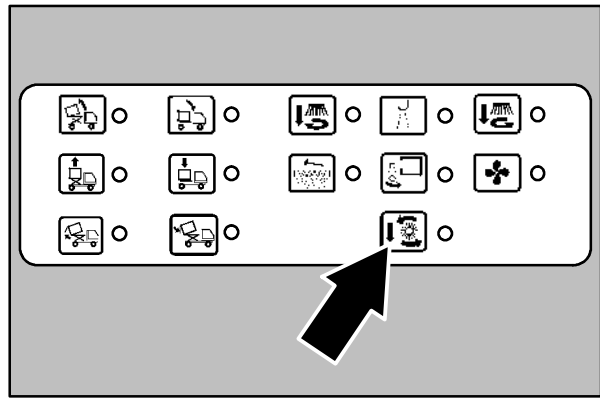

351926

4-WAY WARNING LIGHTS SWITCH

The *4-way warning lights switch* powers on and off the warning lights.

On: Press the top of the 4-way warning lights switch. The light will come on.

Off: Press the bottom of the 4-way warning lights switch. The light will go off.

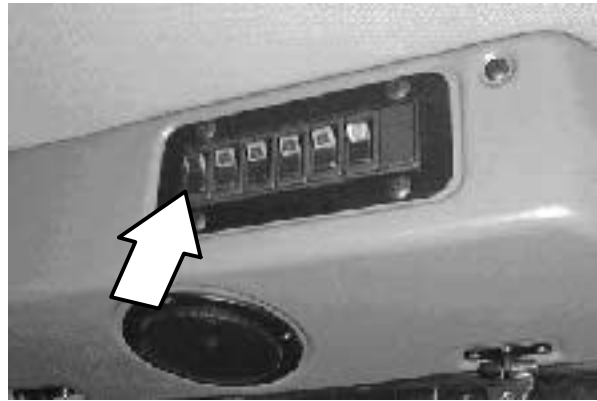
**HAZARD LIGHT SWITCH**

The *hazard light switch* powers on and off the hazard light.

On: Press the top of the hazard light switch. The light will come on.

Off: Press the bottom of the hazard light switch. The light will go off.

**SIDE BRUSH SPOT LIGHT(S) SWITCH**

The *side brush spot light(s) switch* powers on and off the side brush spot light(s).

On: Press the top of the side brush spot light(s) switch. The light(s) will come on.

Off: Press the bottom of the side brush spot light(s) switch. The light(s) will go off.



OPERATION

REAR NIGHT SWEEPING LIGHT SWITCH (OPTION)

The *rear night sweeping light switch* powers on and off the rear sweeping light.

On: Press the top of the rear night sweeping light switch. The light will come on.

Off: Press the bottom of the rear night sweeping light switch. The light will go off.

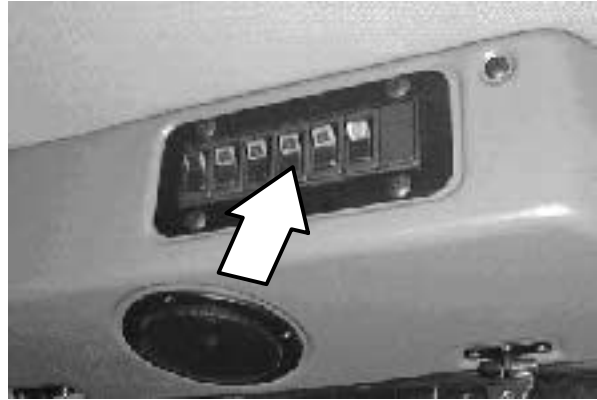

FRONT NIGHT SWEEPING LIGHT SWITCH (OPTION)

The *front night sweeping light switch* powers on and off the front sweeping light.

On: Press the top of the front night sweeping light switch. The light will come on.

Off: Press the bottom of the front night sweeping light switch. The light will go off.

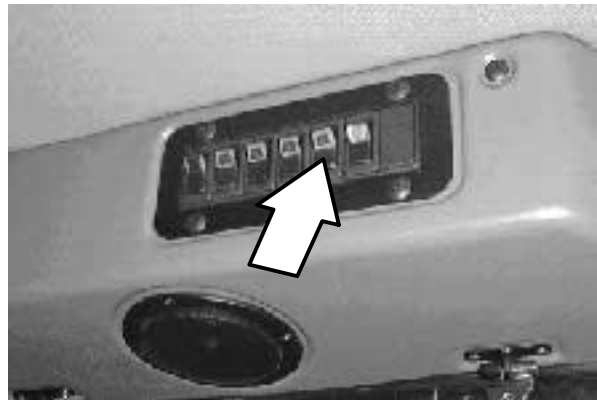

HIGH PRESSURE WASHER SWITCH (OPTION)

The *high pressure washer switch* powers on and off the high pressure washer.

On: Press the top of the high pressure washer switch. The light will come on.

NOTE: The high pressure washer option will not operate unless the parking brake is set.

Off: Press the bottom of the high pressure washer switch. The light will go off.

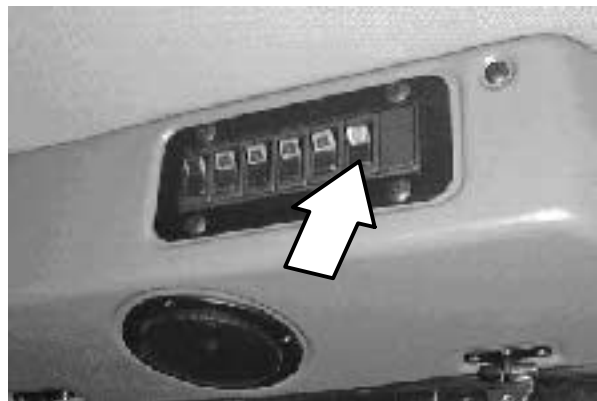

FOR SAFETY: When using pressurized air or water, wear eye and ear protection.

DOMES AND MAP LIGHT SWITCH

The *dome and map light switch* controls the dome and map light on the ceiling of the cab.

Map Light On: Push the switch toward the passenger side of the cab.

Dome and Map Light On: Pull the switch toward the operator side of the cab.

Off: Place the switch to the middle position.

**RADIO AND CASSETTE PLAYER (OPTION)**

The *radio and cassette player* is located above the operator. Refer to the radio/cassette player's manual for operation.

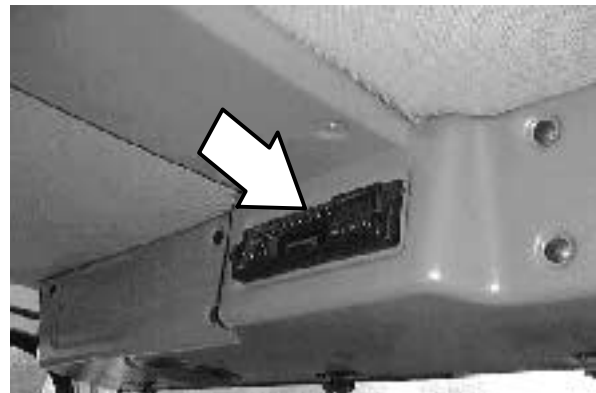
**LATCHES**

The cab doors, side doors, and main brush access doors are secured with latches.

Open the Cab Doors: Pull out on the latch handle.

Open the Side Doors: Pull out on the latch handle.

Open the Main Brush Access Doors: Pull on the rubber latch until the door is loose. Remove the door by pulling the door from the pins in the machine frame.



OPERATION

HOPPER SUPPORT PIN

The hopper support pin holds the hopper in the tilt back position to allow work under the hopper. DO NOT rely on the machine hydraulic system to keep the hopper raised. See *ENGAGING HOPPER SUPPORT PIN* section of this manual.

 **WARNING: Raised hopper may fall.**
Engage hopper support pin.

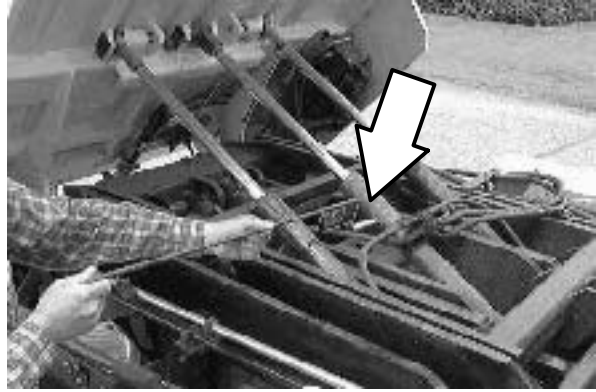

The hopper support pin is stored on the right rear fender under the hopper.

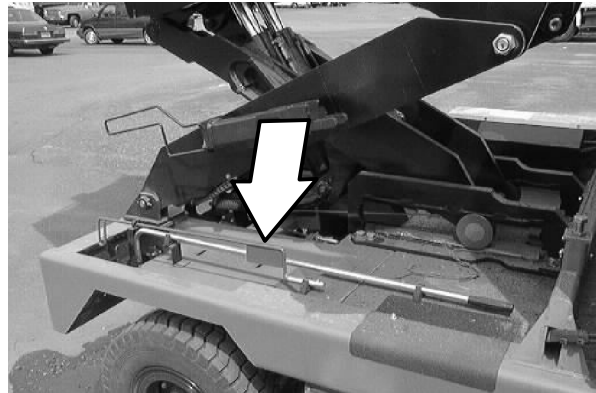

HOPPER SUPPORT BAR (High Dump Model)

The hopper support bar holds the hopper in the raised position to allow work under the hopper. DO NOT rely on the machine hydraulic system to keep the hopper raised. See *ENGAGING HOPPER SUPPORT BAR* section of this manual.

 **WARNING:** Raised hopper may fall.
Engage hopper support bar.

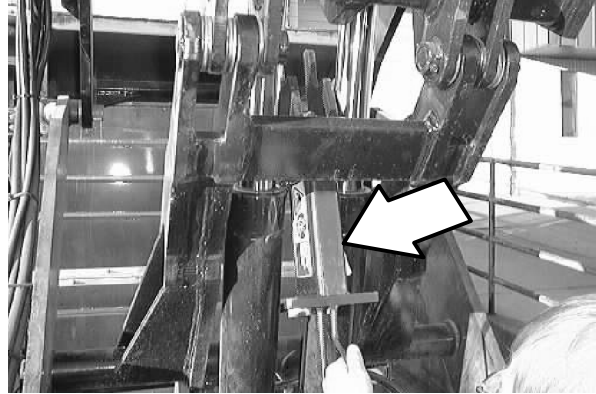

The hopper support bar is stored on the right side of the lift arms.

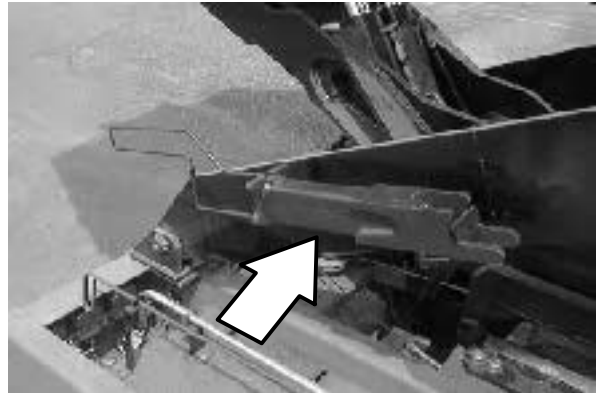

HOW THE MACHINE WORKS

The steering wheel controls the direction of machine travel. The directional lever controls the forward/reverse direction. The propelling pedal controls machine speed. The brake pedal slows and stops the machine.

The side brush sweeps debris into the path of the main brush. The main brush sweeps debris from the surface onto the conveyor, which transfers the debris into the hopper. The vacuum system pulls dust and air through the hopper and the hopper dust filter.

The machine has a right side brush, an optional Vario Sweeping Brush™, and an optional left side brush. There is also either a wet or dry dust control system.

When sweeping is finished, clean the hopper dust filter and empty the hopper.

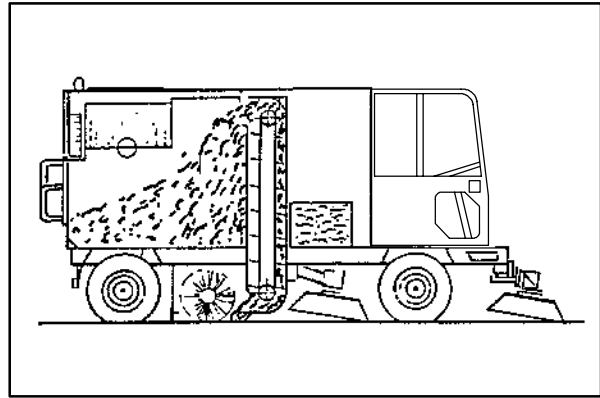

351929

PRE-OPERATION CHECKLIST

- Check under the machine for leaks (fuel, oil, coolant).
- Check the air filter intake screen at the top of the engine air cleaner.
- Check the engine oil level.
- Check fuel level.
- Check the brakes and steering for proper operation.
- Check fuel filter water trap for water.
- Check the coolant level in the overflow reservoir.
- Check the radiator core exterior and hydraulic cooler fins for debris.
- Check the windshield washer fluid level.

STARTING THE MACHINE

1. Check the *directional lever* to make sure it is in the middle neutral position.

NOTE: Machine will not start unless the directional lever is in the neutral position.

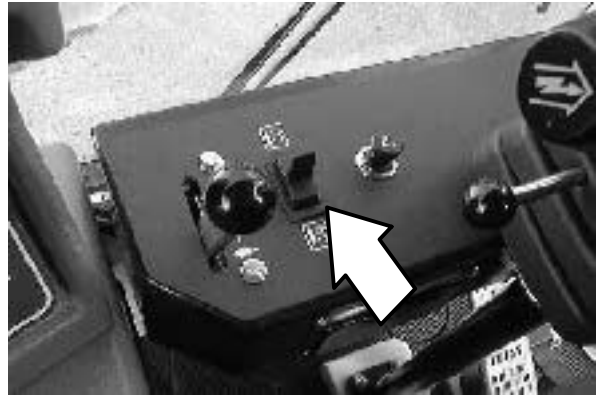

2. Sit in the operator's seat and fasten the seat belt. Place your foot on the *brake pedal* or set the parking brake.

NOTE: The machine will not propel unless the operator is in the seat.



3. Move the *throttle lever* back to the idle position.



OPERATION

4. Turn the key counter-clockwise. The glow plugs light will come on. When the glow plug light goes out, usually for 5 to 30 seconds depending on the weather conditions, the engine is ready to start.

NOTE: The preheat is not necessary if the temperature is above 10° C (50° F).

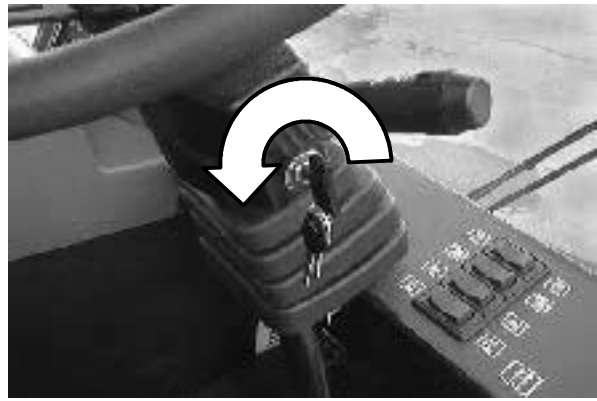

5. Turn the ignition switch key clockwise until the engine starts.

NOTE: Do not operate the starter motor for more than 10 seconds at a time or after the engine has started. Allow the starter to cool between starting attempt or damage to the starter motor may occur.

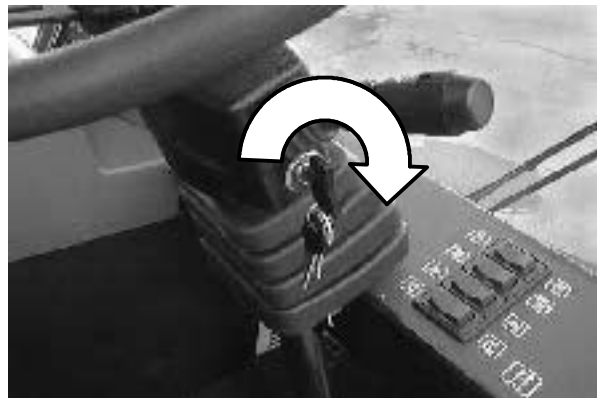

6. Allow the engine and hydraulic system to warm up three to five minutes.

⚠ WARNING: Engine emits toxic gases. Severe respiratory damage or asphyxiation can result. Provide adequate ventilation. Consult with your regulatory agency for exposure limits. Keep engine properly tuned.

7. Adjust the *throttle lever* to the desired engine speed.



8. Press the bottom of the *parking brake switch* to release the parking brake.

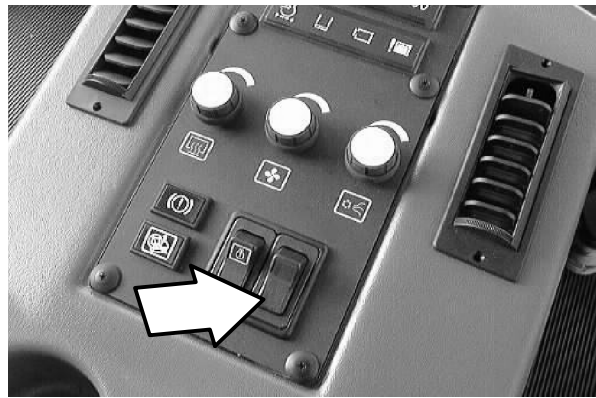

9. Place the *directional lever* in the **Forward** position.



10. Release the brake pedal and press on the propelling pedal to transport the machine. The more foot pressure, the faster the machine will travel.

NOTE: The machine will not propel unless the operator is in the seat and the parking brake is released.

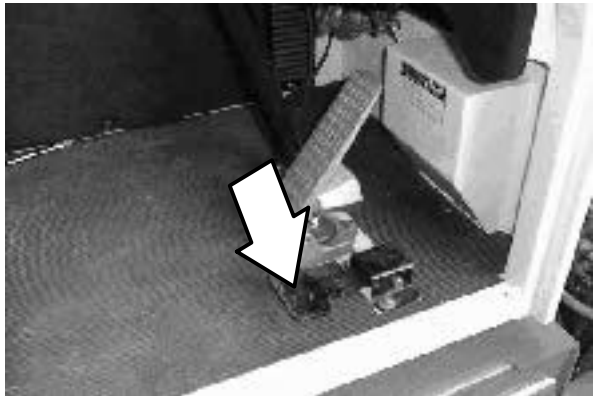

11. Drive the machine to the area to be swept. When transporting to the sweeping area and equipped with the *Vario Sweeping Brush™*, lock the brush into the travel support with the guide pin.

FOR SAFETY: When using machine, always follow safety and traffic rules.

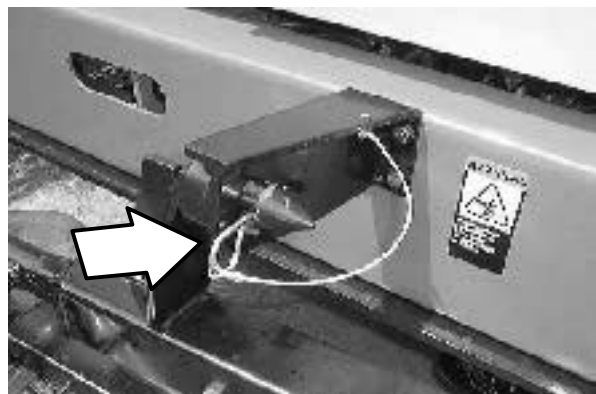

SWEEPING AND BRUSH INFORMATION

The model 830-II has a GVWR of 9072 kg (20,000 lb) or 4536 kg (10,000 lb) per axle. Operate only on surfaces capable of supporting this weight.

Avoid bulky debris such as crates, boxes, tree branches, and very heavy material. Avoid pieces of straps, twine, rope, etc., which could become entangled in brush, brush plugs or the conveyor.

Plan the sweeping in advance. Try to arrange long runs with minimum stopping and starting. Sweep as straight a path as possible. Overlap the brush paths.

Avoid turning the steering wheel too sharply when the machine is in motion. The machine is very responsive to the movement of the steering wheel. Avoid sudden turns, except in emergencies.

Use the wet dust control option in dusty conditions. With wet roads, do not use the wet dust control option.

For best results, use the correct brush type for your sweeping application. The main sweeping brush is a polypropylene brush. The following are recommendations for side brush and *Vario Sweeping Brush*™.

Polypropylene and Wire Side Brush - Recommended for general purpose sweeping. Best combination of sweeping and aggressiveness.

Flat Wire Side Brush - Recommended for outside and curb-side sweeping where soilage is heavy or compacted. The stiff wire bristles dig out soilage. This brush does not sweep as good as the *Polypropylene and Wire Side Brush* but is recommended for foundry sweeping where heat may melt synthetic bristles.

Polypropylene Side Brush - Recommended for sweeping where you cannot have wire fragments. This brush does not sweep as good as the *Polypropylene and Wire Side Brush* but is recommended for areas such as airports.



SWEEPING

1. Check the switch panel to make sure that all the hopper control lights are off. The hopper must be in a fully lowered and forward position with the hopper door closed before sweeping.

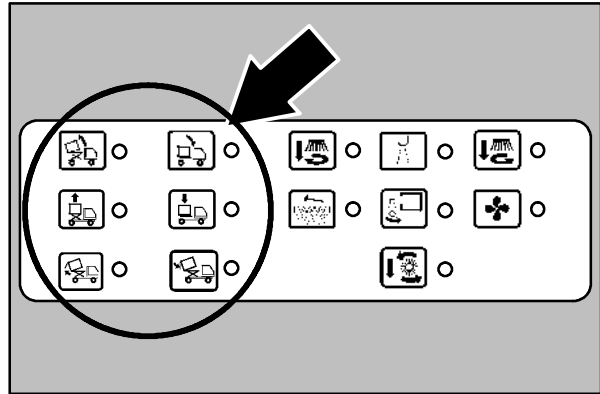

351926

2. Check the switch panel to make sure that the *conveyor reverse switch* is NOT lit. When the light is NOT on, this indicates that the conveyor is in the forward sweeping direction.

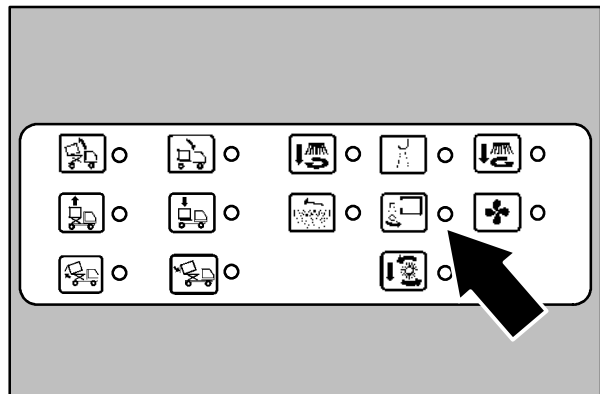

351926

3. Adjust and start the *Vario Sweeping Brush™* if equipped. Refer to the *Vario Sweeping Brush™* section of this manual.

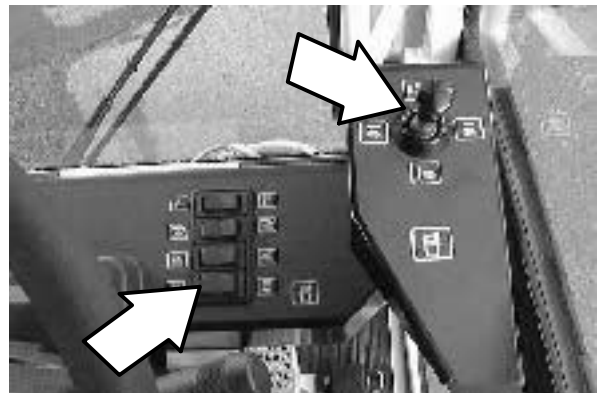

OPERATION

4. Move the *throttle lever* till the tachometer shows the desired engine RPM for the type of sweeping you are doing. Refer to the following chart.

Debris	Engine RPM	Travel Speed
General Debris	1600-1800 RPM	(5-13 kmh) 3-5 mph
Fine Dust	1500-1800 RPM	(5-13 kmh) 3-5 mph
Light Debris (Leaves, grass) (Shake filter often)	1800-2000 RPM	(5-13 kmh) 3-5 mph
Wet Sweeping (Vacuum fan on)	1800-2000 RPM	(5-13 kmh) 3-5 mph
Heavy Debris	1800-2000 RPM	Slower than 5 kph (3 mph)
Vacuum Wand (Ear plugs mandatory)	2400-2500 RPM	None

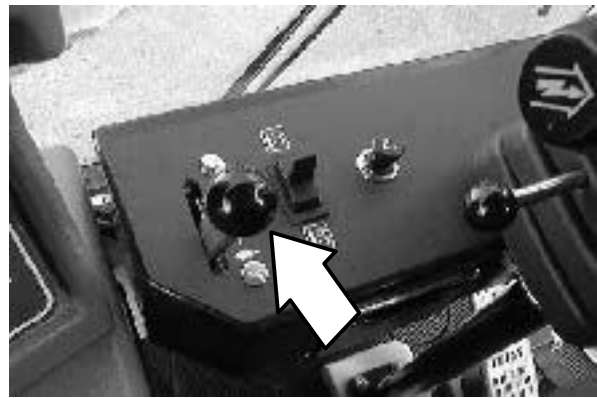

NOTE: Do NOT sweep with engine speed higher than 2000 RPM. If the engine speed is operating above 2000 RPM, the green SWEEP light will blink and an audio alarm will sound. This will continue for 15 seconds, then the main sweeping functions will lift and turn off.

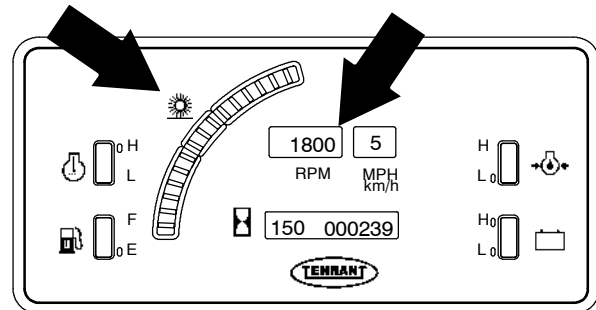

351927

5. Press the *sweep switch*. This will lower and start the sweeping functions. The lights next to these switches will come on.

NOTE: The side brushes will automatically turn on with the SWEEP SWITCH ***IF*** they were in the ***on*** position when the sweep switch was last turned off.

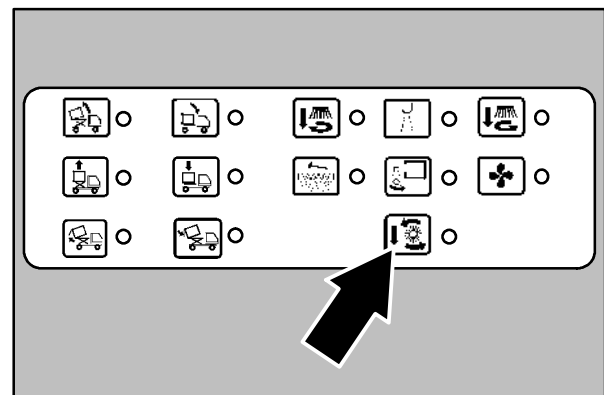

351926

6. Start the *wet dust control system* if equipped. Refer to the *wet dust control system* section of this manual.

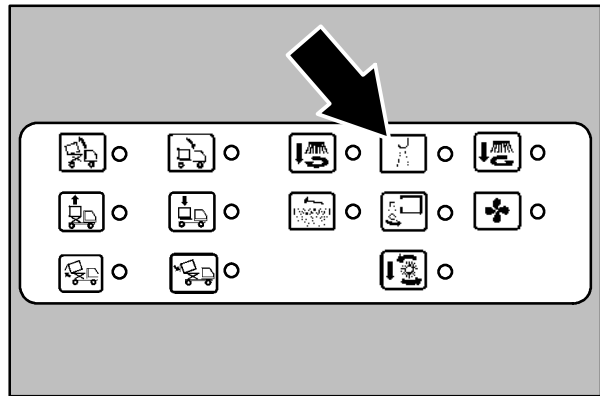

351926

7. Press the side brush switch(es). This will lower and start the side brush(es). The light(s) next to the switch(es) will come on.

*NOTE: The side brushes will automatically turn on with the SWEEP SWITCH **IF** they were in the **on** position when the sweep switch was last turned off.*

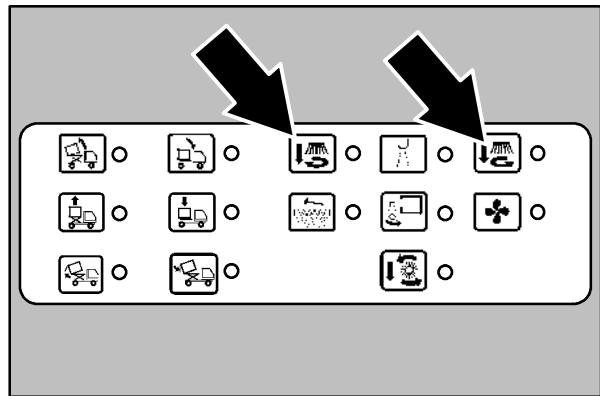

351926

8. Press the bottom of the *parking brake switch* to release the parking brake.

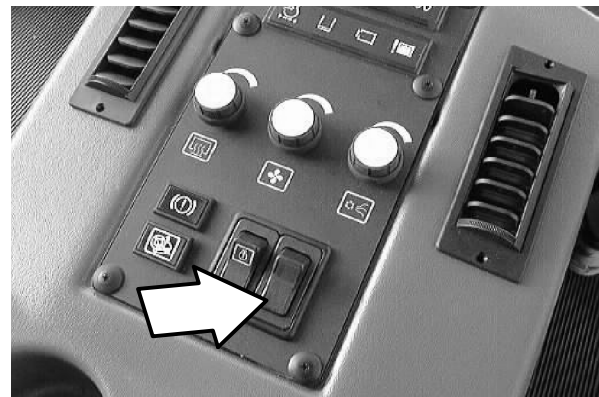

9. Press the *propelling pedal* and start sweeping.

NOTE: In dusty conditions, periodically place the engine throttle in the idle position and shake clean the hopper dust filter.

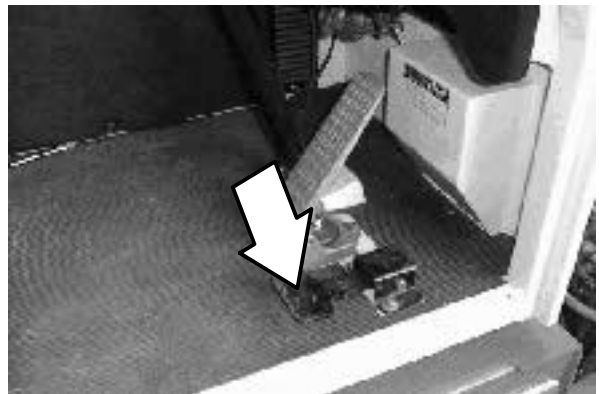

OPERATION

10. Stop sweeping if the conveyor overload alarm sounds. This alarm means that either a large object is jammed in the conveyor, that there is too much heavy debris in the conveyor, or that the hopper opening is filled.

If a large object is jammed in the conveyor, the alarm will sound constantly even *after* the machine is stopped. To clear the jammed object, stop sweeping, reduce the engine speed, and place the debris lift direction switch in the reverse position until the debris is removed. Then place the switch back in the forward position and continue sweeping.

If there is too much heavy debris in the conveyor, the alarm will sound constantly *until* the machine has stopped. This means that the debris must be swept at a slower travel speed.

If the hopper opening is filled, the alarm will *chirp* intermittently. The opening can be cleared by redistributing the debris in the hopper. To do this, stop sweeping and tilt the hopper back. Then return the hopper to the sweeping position and continue to sweep.

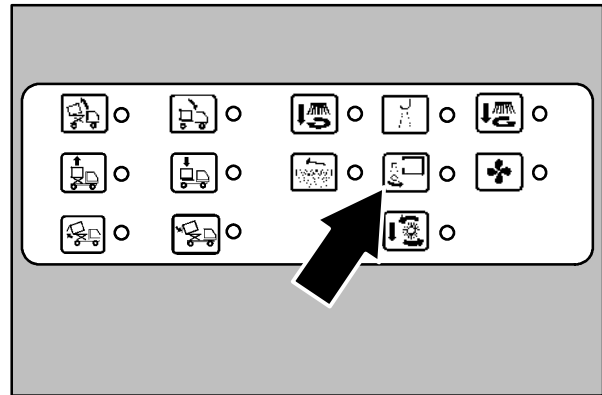

351926

STOP SWEEPING

1. Press the *sweep switch*. This will raise and stop the sweeping functions. The lights next to these sweeping function switches will turn off.

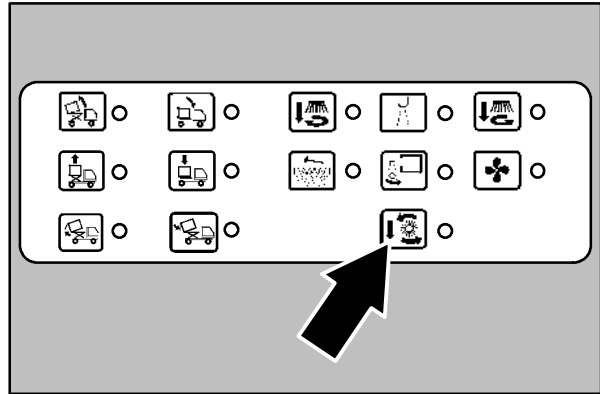

351926

2. Stop the *wet dust control system* if equipped. Refer to the *wet dust control system* section of this manual.

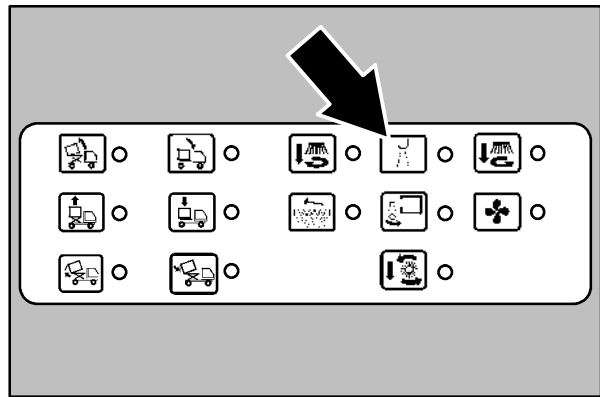

351926

3. Check to make sure all the sweeping function lights are out. If any lights are lit, press the switch to turn it off.

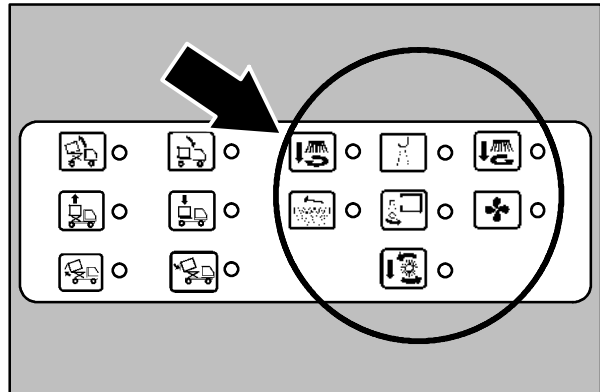

351926

OPERATION

4. Stop the *Vario Sweeping Brush™* if equipped. Refer to the *Vario Sweeping Brush™* section of this manual.

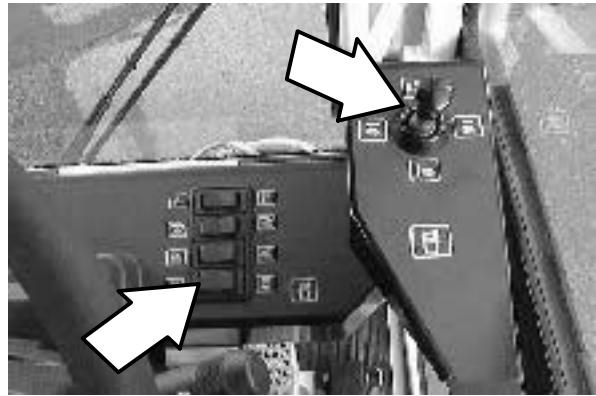

5. Place the *engine throttle* in the idle position and press the *filter shaker switch* to clean the hopper filter. The filter will shake for about 30 seconds. The light next to the switch will come on while the filter is shaking, then turn off.

*NOTE: Shake the dust filter **before** tilting the hopper.*

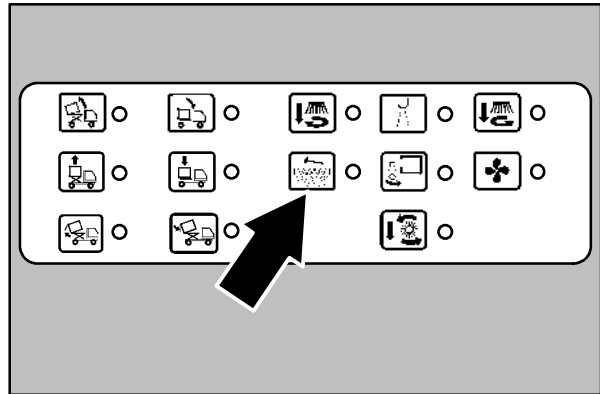

351926

EMPTYING THE HOPPER

1. Drive the machine slowly to the debris collection site or debris container. Make sure the machine is on level ground before dumping the hopper.

FOR SAFETY: Only dump the hopper on a level surface.

2. Press and hold the brake pedal with your foot, then push the throttle lever forward to increase the engine speed.

NOTE: The hopper will not lift or tilt unless the parking brake is set or the service brake is applied.



3. For High Dump Model: Press and hold the *hopper lift switch* until the hopper is at the desired raised position, then release the switch. An audio alarm will sound when the hopper is moving.

NOTE: The hopper will not lift if the optional hopper incline or overload light is on. This indicates that the machine is either on an incline that is unsafe or that the hopper is too heavy for high dumping the hopper.

NOTE: Be aware that the minimum ceiling height needed to high dump the hopper is 5060 mm (16.6 ft).

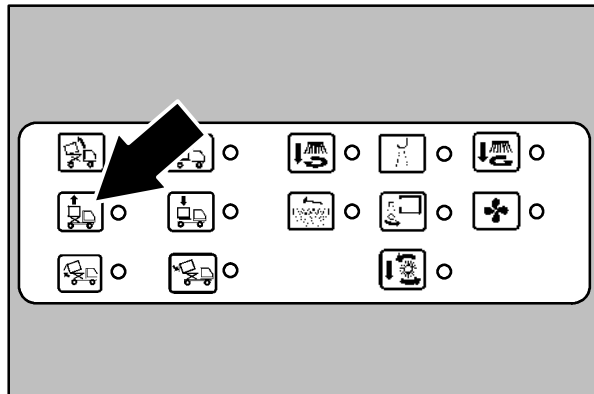

351926

⚠ WARNING: High dump vertical clearance. Stay clear of overhead obstructions and power lines.

OPERATION

- Place the *directional lever* in the *reverse* position, release the brake and slowly back the machine up to the debris site or container.

FOR SAFETY: Move machine with care when hopper is raised.

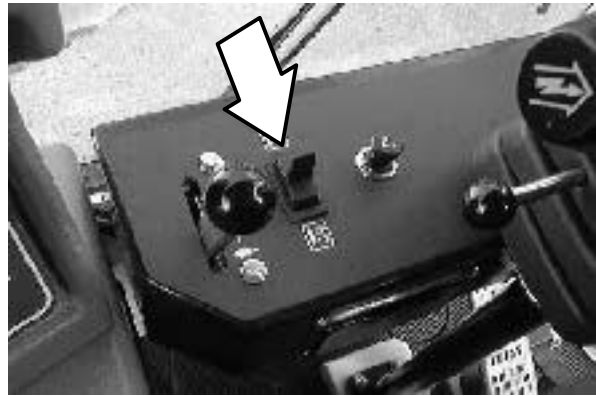

- Press and hold the brake pedal with your foot.

NOTE: The hopper will not lift or tilt unless the parking brake is set or the service brake is applied.



- Press and hold the *hopper tilt back switch* until the hopper is in the desired tilted position, then release the switch. An audio alarm will sound when the hopper is moving.

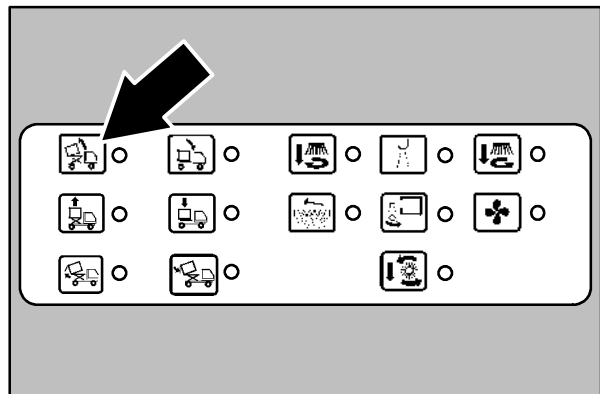

351926

- Press and hold the *hopper door open switch* for 2-3 seconds. The hopper door will open and the debris will fall out.

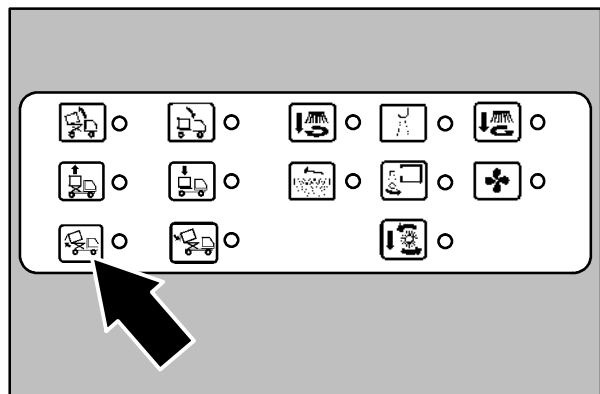

351926

8. Place the *directional lever* in the *forward* position, release the brake and slowly drive the machine away from the debris site or container.

FOR SAFETY: Move machine with care when hopper is raised.

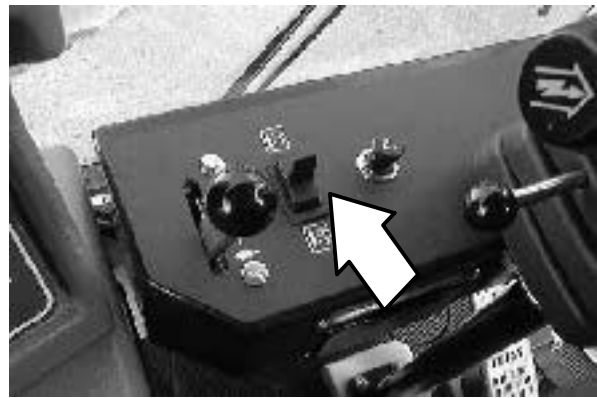

9. Press and hold the brake pedal with your foot.

NOTE: The hopper will not lift or tilt unless the parking brake is set or the service brake is applied.



10. Press and hold the *hopper tilt forward* switch until the hopper is fully forward, then release the switch. An audio alarm will sound when the hopper is moving.

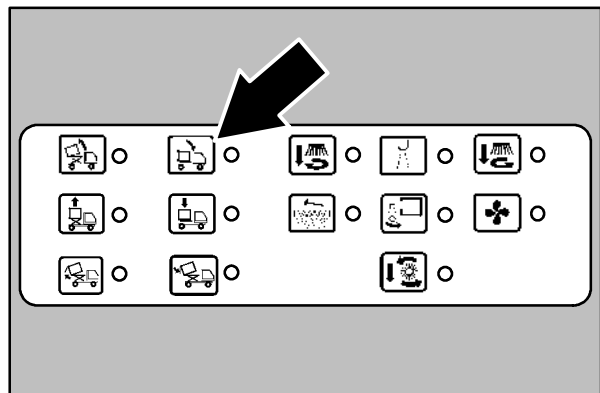

351926

OPERATION

11. Press and hold the *hopper door close switch* for 2-3 seconds. The hopper door will latch in the closed position.

 **WARNING: Hopper door pinch point.**
Stay clear of hopper door.

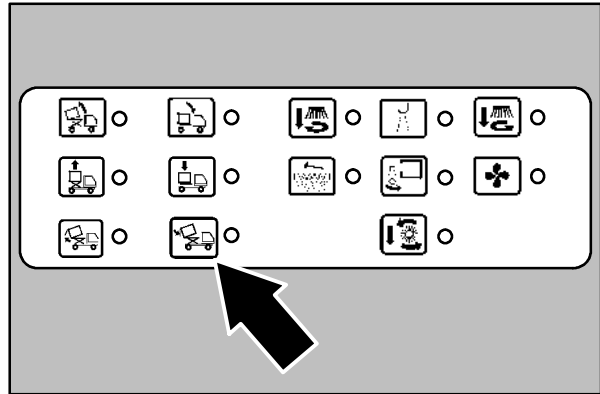

351926

12. For High Dump Model: Press and hold the *hopper lower switch* until the hopper is fully lowered, then release the switch. An audio alarm will sound when the hopper is moving.

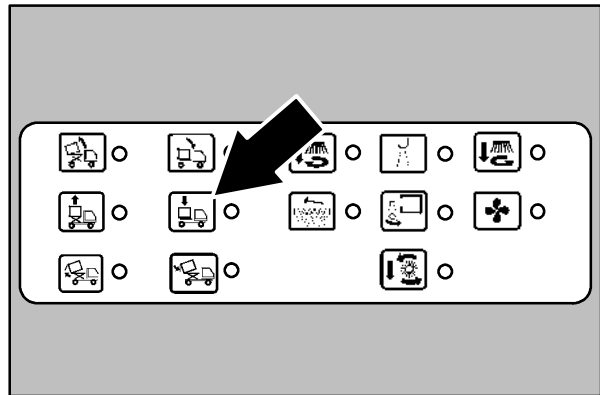

351926

13. Check the switch panel to make sure that all the hopper control lights are off. The hopper must be in a fully lowered and forward position with the hopper door closed before sweeping again.

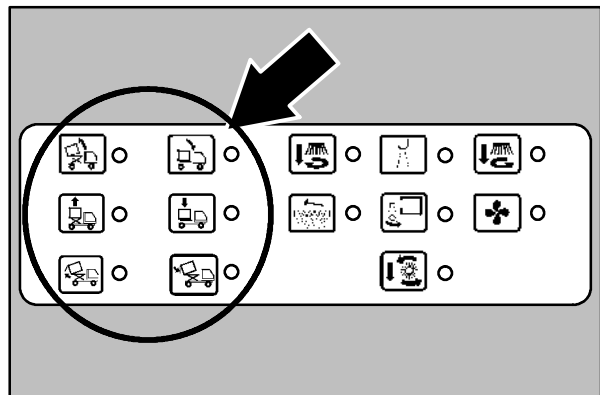

351926

STOP THE MACHINE

1. Stop sweeping. Refer to the *STOP SWEEPING* section of this manual.
2. Take your foot off the propelling pedal. Step on the brake pedal.



3. Move the *throttle lever* back to the idle position.



4. Press on the top part of the *parking brake switch* to set the parking brake.

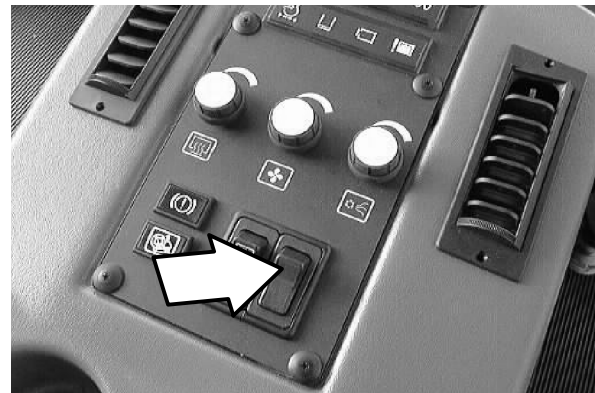

OPERATION

5. Turn the ignition switch key counter-clockwise to stop the engine. Remove the switch key.

FOR SAFETY: Before leaving or servicing machine, stop on level surface, set parking brake, turn off machine and remove key.

6. Turn off all accessories such as lights, water valves, and the cab fan. Even with the machine off, many of these accessories will continue to operate unless turned off.

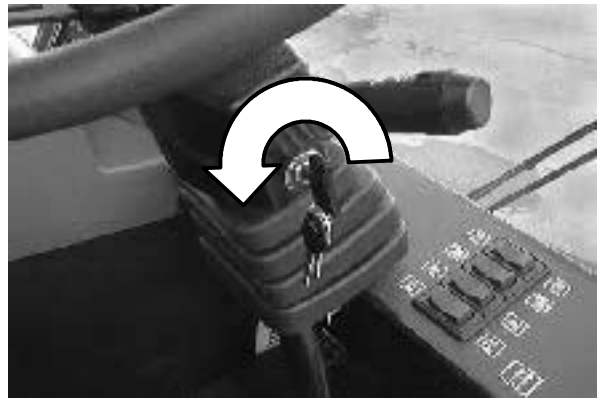

POST-OPERATION CHECKLIST

- Check the main brush adjustment. See *TO CHECK AND ADJUST MAIN BRUSH PATTERN* in the *MAINTENANCE* section of this manual.
- Check the brush skirts for damage and wear.
- Check for wire or string tangled on the main and side brushes.
- Check for fuel odor that indicates a fuel leak.
- Check under the machine for leak spots (fuel, oil, coolant).
- Check the service records to determine maintenance requirements.

ENGAGING HOPPER SUPPORT PIN

1. Press on the top part of the *parking brake switch* to set the parking brake.

FOR SAFETY: Before leaving or servicing machine, stop on level surface, set parking brake, turn off machine and remove key.

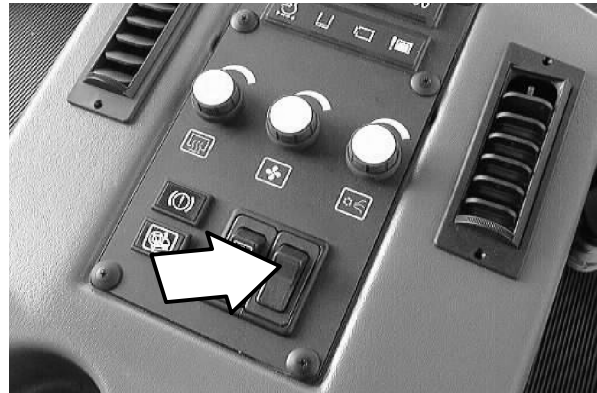

2. Start the engine and push the throttle lever forward to increase the engine speed.



3. Press and hold the *hopper tilt back switch* until the hopper is in the fully tilted position. An audio alarm will sound when the hopper is moving.

NOTE: The hopper will not lift or tilt unless the parking brake is set or the service brake is applied.

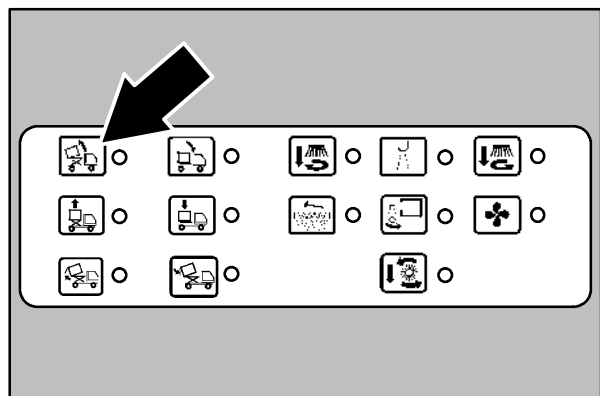

351926

4. Remove the hopper support pin from the storage location on the right rear fender and place it into the hole of the hopper support cylinder.

⚠ WARNING: Raised hopper may fall. Engage hopper support bar.

5. Pull the throttle lever back to the idle position, then turn the ignition switch key counter-clockwise to stop the engine. Remove the switch key.

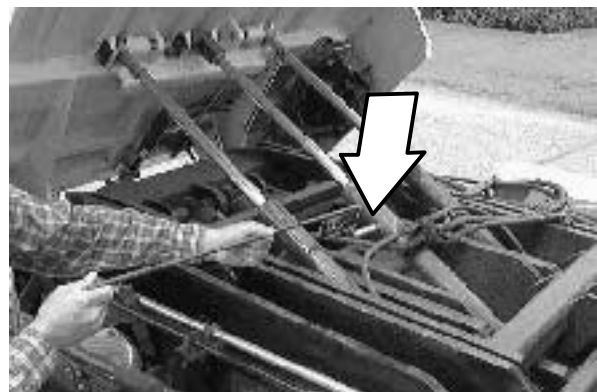

DISENGAGING HOPPER SUPPORT PIN

1. Remove the hopper support pin and fasten it in the storage location on the right rear fender.



WARNING: Lift arm pinch point. Stay clear of hopper lift arms.

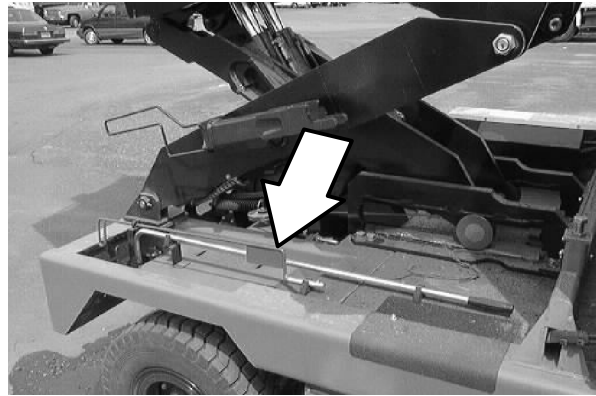

2. Start the engine and push the throttle lever forward to increase the engine speed.



3. Press and hold the *hopper tilt forward switch* until the hopper is fully forward. An audio alarm will sound when the hopper is moving.

NOTE: The hopper will not lift or tilt unless the parking brake is set or the service brake is applied.

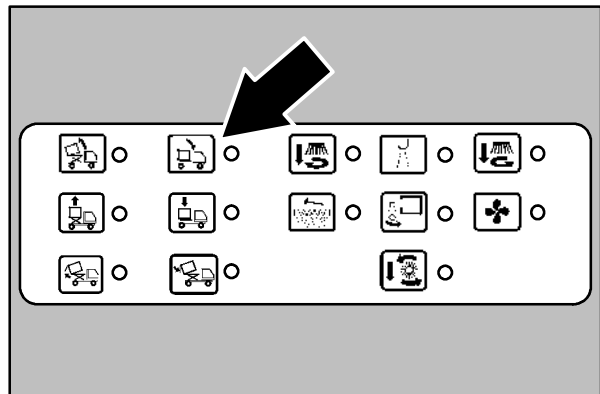

351926

4. Pull the throttle lever back to the idle position, then turn the ignition switch key counter-clockwise to stop the engine. Remove the switch key.

ENGAGING HOPPER SUPPORT BAR (High Dump Model)

1. Press on the top part of the *parking brake switch* to set the parking brake.

FOR SAFETY: Before leaving or servicing machine, stop on level surface, set parking brake, turn off machine and remove key.

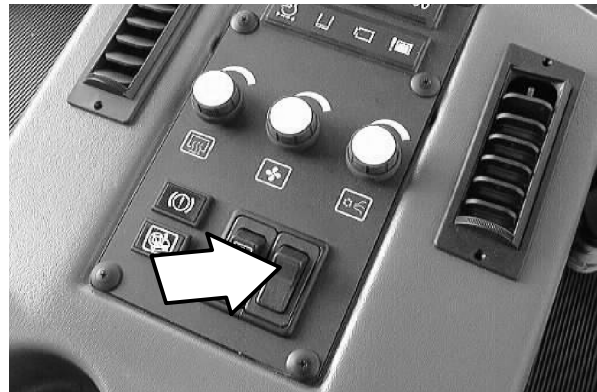

2. Start the engine and push the throttle lever forward to increase the engine speed.



3. Press and hold the *hopper lift switch* until the hopper is in the fully raised position, then release the switch. An audio alarm will sound when the hopper is moving.

NOTE: The hopper will not lift or tilt unless the parking brake is set or the service brake is applied.

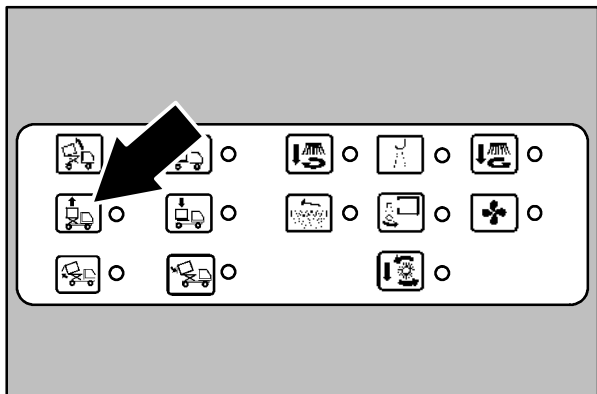

351926

4. Remove the hopper support bar from the storage location on the right side of the lift arms.

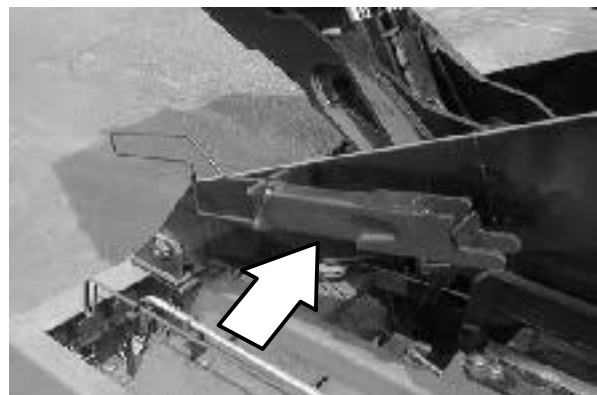

OPERATION

5. Install the support bar from the rear of the machine by first placing it behind the horizontal bar of the lift arms.

 **WARNING: Raised hopper may fall. Engage hopper support bar.**

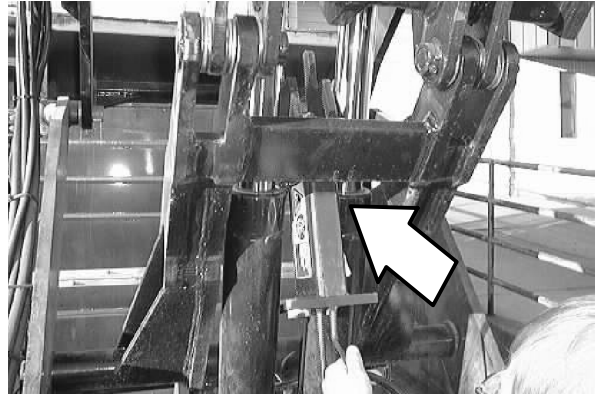

6. Align the tabs of the support bar with the shaft of the lift arms. The longer tabs go toward the front of the machine.

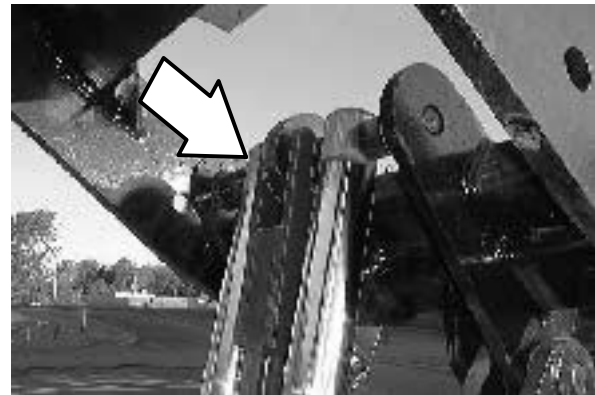

7. Place the base part of the support bar on top of the lift cylinders. Then release the bar.



8. Pull the throttle lever back to the idle position, then turn the ignition switch key counter-clockwise to stop the engine. Remove the switch key.

**DISENGAGING HOPPER SUPPORT BAR
(High Dump Model)**

1. Remove the support bar from lift arms and fasten it in the storage location on the right rear fender.

⚠ WARNING: Lift arm pinch point. Stay clear of hopper lift arms.

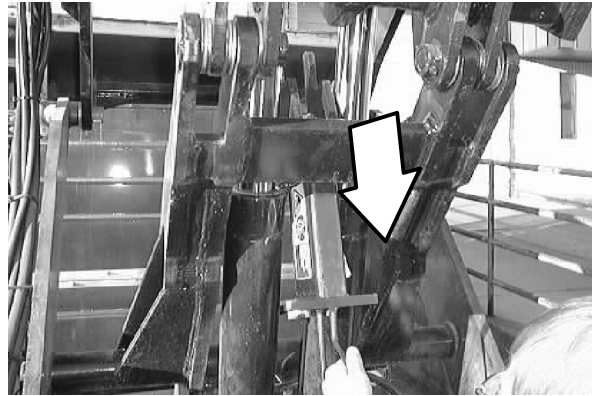

2. Start the engine and push the throttle lever forward to increase the engine speed.



3. Press and hold the *hopper lower switch* until the hopper is fully lowered, then release the switch. An audio alarm will sound when the hopper is moving.

NOTE: The hopper will not lift or tilt unless the parking brake is set or the service brake is applied.

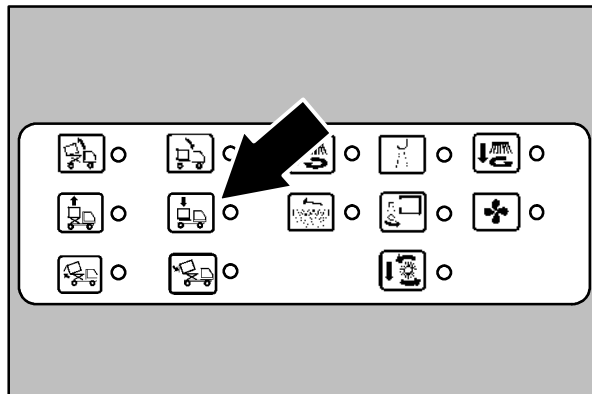

351926

4. Pull the throttle lever back to the idle position, then turn the ignition switch key counter-clockwise to stop the engine. Remove the switch key.

OPERATION ON INCLINES

Drive the machine slowly on inclines and make sure your seat belt is fastened. Use the brake pedal to control machine speed on descending inclines.

The maximum rated incline when driving the machine with the hopper down is 12° with an empty hopper, and 8° with a full hopper.

Do not drive the machine on inclines with the hopper raised.

FOR SAFETY: Move machine with care when hopper is raised.

The *incline light* will come on when the machine is on an incline that is unsafe for high dumping the hopper. It will come on when the front to back incline is more than 8° and the side to side incline is more than 4°. The machine will not high dump when this light is on.

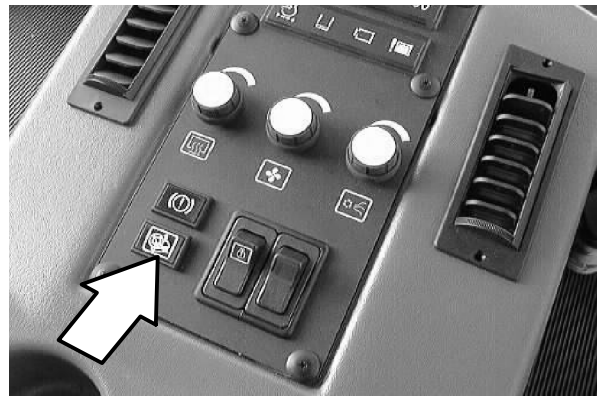

OPTIONS

VARIO SWEEPING BRUSH™

The *Vario Sweeping Brush™* allows side brush sweeping on the left or right side of the machine. The brush arm moves along the front of the machine. The brush angle, movement, front and side tilt, and direction of rotation are adjusted for the right or left side.

NOTE: The brush arm is locked to the front of the machine during transport. Make sure to take the hair cotter pin from the lock pin before the brush is operated.

⚠ WARNING: Brush linkage pinch points. Stay clear when linkage is moving.

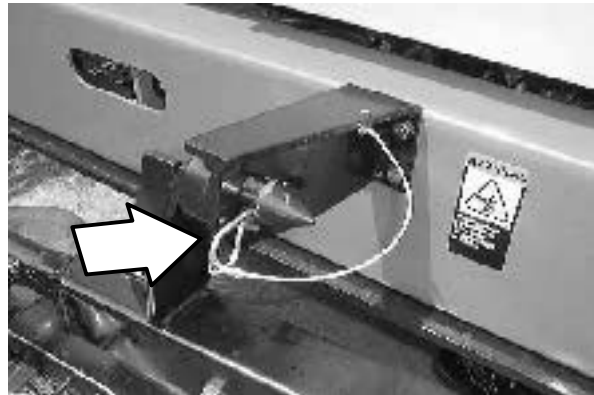

1. Start the brush with the *Vario Sweeping Brush™ on-off switch*. Push the right part of the switch for right side sweeping. Push the left part of the switch for left side sweeping.



2. Move the *Vario Sweeping Brush™* from the storage position with the joystick. Then use the joystick to move the brush to the desired left-right and up-down position. The sweeping brush arm stays parallel to the front of the machine when using the joystick.



OPERATION

3. Swing the *Vario Sweeping Brush™* to the right or left side of the machine as needed with the *Vario Sweeping Brush™ swing switch*.



4. Adjust the front angle of the brush, for less angle, and for more angle, with the *Vario Sweeping Brush™ front angle switch*.



5. Adjust the side angle tilt of the brush with the *Vario Sweeping Brush™ side angle switch*. Use for the left and right side of the machine.



WET DUST CONTROL SYSTEM

The *wet dust control system* is useful in dusty conditions to control the dust created by the side brushes and *Vario Sweeping Brush™*. The system consists of a water tank, a water pump, and spray nozzles for each of the side brushes.

1. Press on the top part of the *parking brake switch* to set the parking brake and turn the machine off.

FOR SAFETY: Before leaving or servicing machine, stop on level surface, set parking brake, turn off machine and remove key.

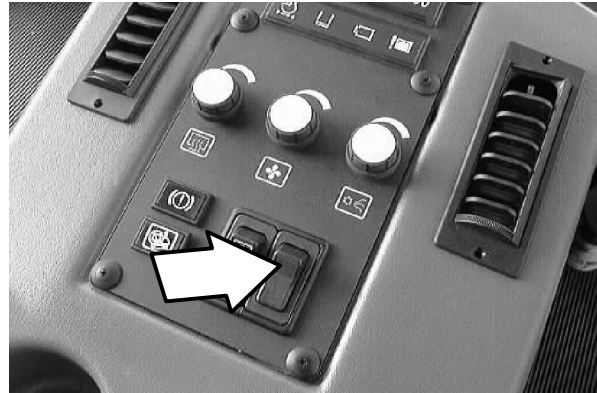

2. Fill the water tank. The fill spout is located in behind the engine access door on the right side of the machine.



WARNING: Flammable materials can cause explosion or fire. Do not use flammable materials in tank. Only use water.



3. Use the clear hose on the side of the tank to check when the water level in the tank.

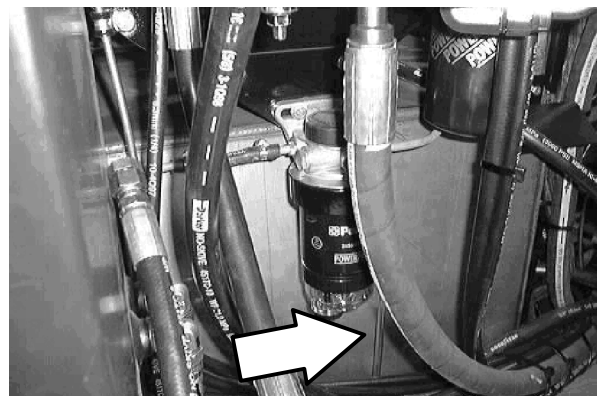

OPERATION

4. Start the machine and turn on the water pump with the *water pump switch*. The light next to the switch will come on.

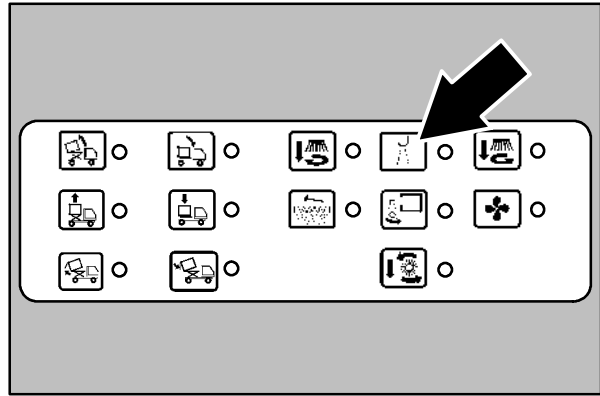

351926

5. Adjust the amount of water spray to each of the brushes with the water valve knobs. Turn the water valve knob clockwise until it comes to a complete stop to close the water supply. If this is NOT done when the machine is shut off, water will continue to flow.

NOTE: The water pump switch needs to be on for the water valves to operate.

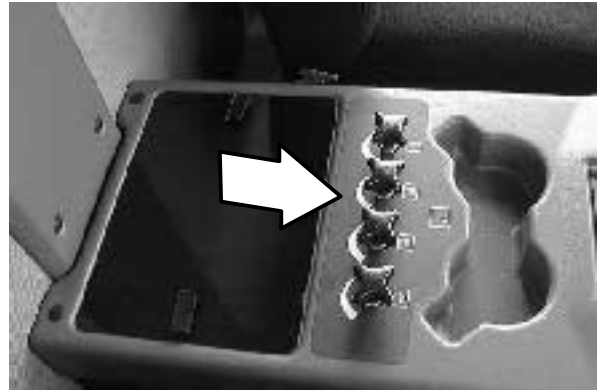

6. The optional *water tank low light* will come on when the water level is low in the tank. The water pump will shut off soon after this light comes on.

NOTE: Do not use the water system on wet roads. Turn off the water pump and water valves.



VACUUM WAND

The vacuum wand uses the machine's vacuum system to allow the pick-up of debris that is out of reach of the machine.

1. Press on the top part of the *parking brake switch* to set the parking brake.

FOR SAFETY: Before leaving or servicing machine, stop on level surface, set parking brake, turn off machine and remove key.

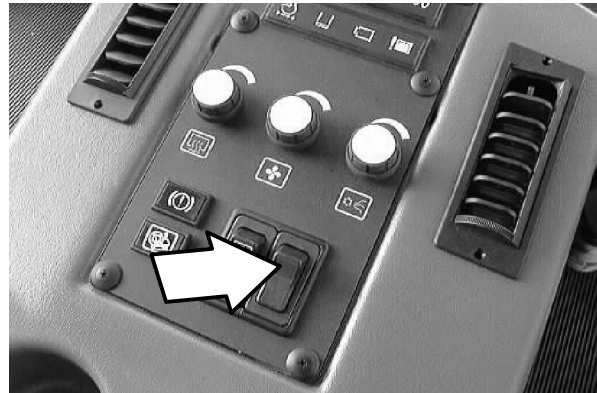

2. Press and hold the *hopper tilt back switch* until the hopper is tilted enough to allow the vacuum door to open.

NOTE: The hopper will not lift or tilt unless the parking brake is set or the service brake is applied.

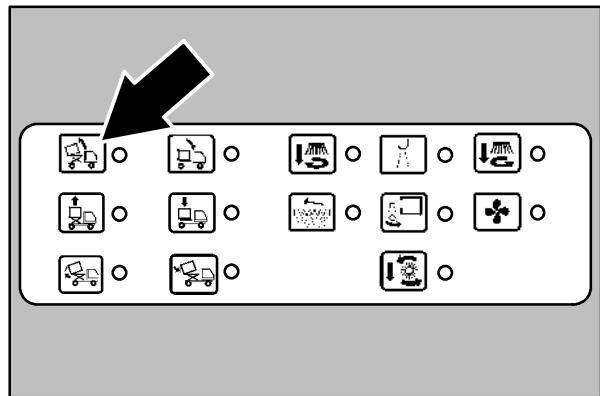

351926

3. Remove the vacuum wand door tool from the storage location on the right rear fender.

⚠ WARNING: Lift arm pinch point. Stay clear of hopper lift arms.



OPERATION

4. Close the vacuum door with the vacuum wand door tool. Place the tool back in its storage location under the hopper.

 **WARNING: Conveyor throws debris. Conveyor pinch point. Stay clear when in operation.**

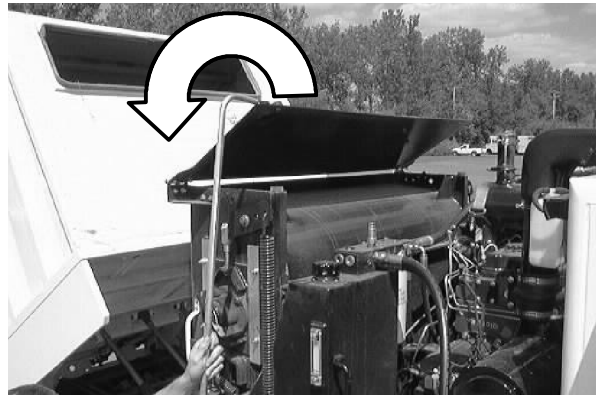

5. Press and hold the *hopper tilt forward* switch until the hopper is fully forward.

NOTE: The hopper will not lift or tilt unless the parking brake is set or the service brake is applied.

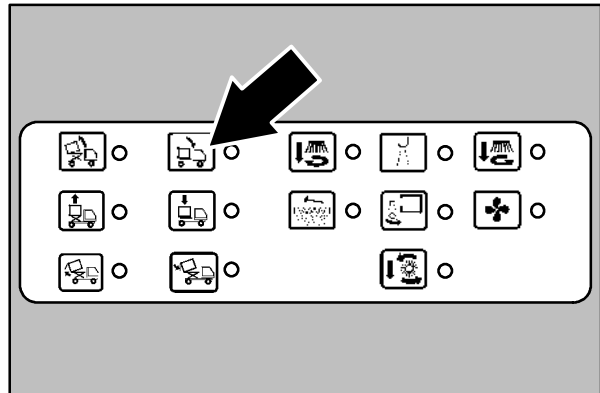

351926

6. Press the *vacuum fan* switch to turn on the vacuum fan. The light next to the switch will come on.

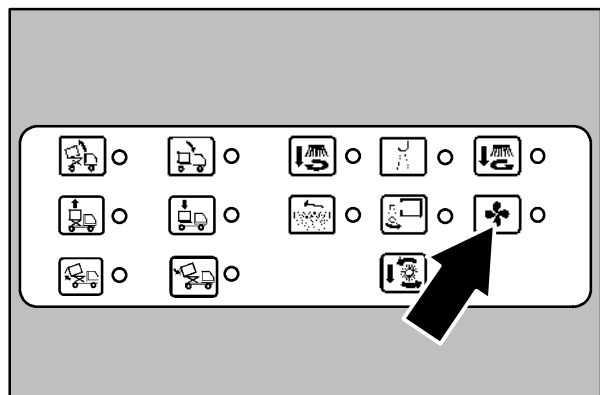

351926

7. Move the *throttle lever* until the engine speed is between 2400 - 2500 RPM.

⚠ WARNING: Machine can emit excessive noise. Consult with your regulatory agency for exposure limits. Hearing loss can result. Wear hearing protection.

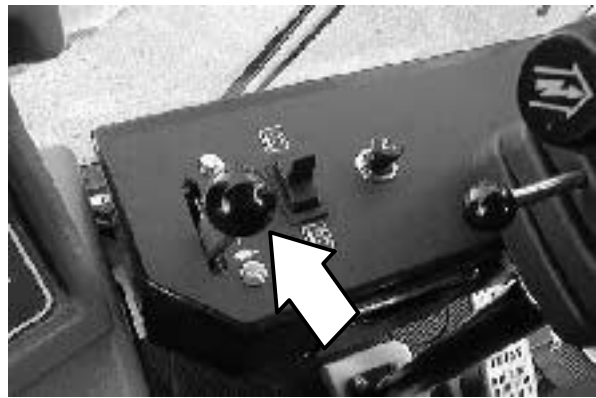

8. Remove the wand from the hopper door and vacuum as required.
9. Place the vacuum wand back on the hopper door when finished.

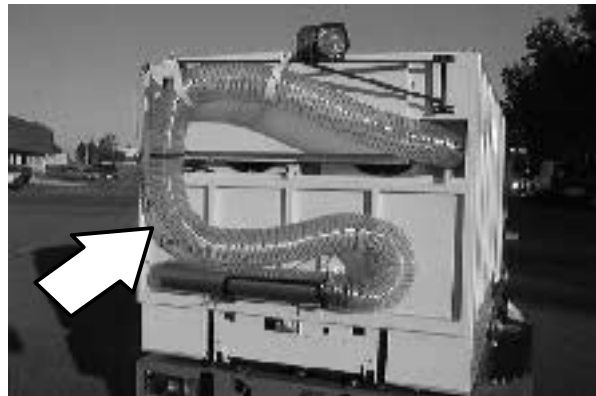

10. Pull the throttle lever to the idle position.
11. Press the *vacuum fan switch* to turn off the vacuum fan. The light next to the switch will turn off.
12. Press and hold the *hopper tilt back switch* until the hopper is in the fully tilted position.
13. Open the vacuum door with the vacuum wand door tool. Place the tool back in the storage location on the right rear fender.

⚠ WARNING: Lift arm pinch point. Stay clear of hopper lift arms.

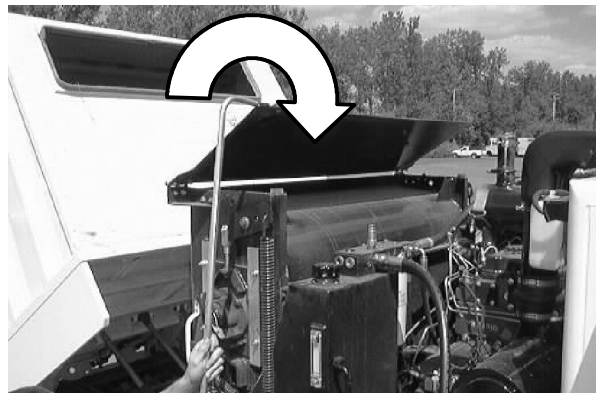

14. Press and hold the *hopper tilt forward switch* until the hopper is fully forward.

OPERATION

MACHINE TROUBLESHOOTING

Problem	Cause	Remedy
Machine does not start	Directional lever in forward or reverse	Place directional lever in neutral
	Glow plug not heated	Heat glow plug
	Fuel tank empty	Fill fuel tank
	Engine oil pressure too low	Check engine oil level
	Engine temperature too high	Check coolant level
Excessive dusting	Brush skirts and dust seals worn, damaged, out of adjustment	Replace or adjust brush skirts or dust seals
	Hopper dust filter clogged	Shake and/or clean or replace dust filter
	Hopper not down completely	Lower hopper completely
	Hopper rear door open	Close and latch hopper rear door
	Vacuum wand door closed	Open vacuum wand door
	Vacuum fan not on	Turn vacuum fan on
	Vacuum fan failure	Contact TENNANT service personnel
	Thermo Sentry™ tripped	Reset Thermo Sentry™
	Water tank empty	Fill water tank
	Wet dust water pump or valves not turned on	Turn on the wet dust control water pump and valves
	Wet dust control filter clogged	Clean or replace filter
Sweeping functions keep raising and turning off	Engine speed too fast	Reduce engine speed
Sweep switch will not activate	Hopper raised or not fully forward	Lower and move hopper fully forward
	Engine throttle to high	Decrease engine throttle
Hopper will not lift or tilt	Machine on too steep of an incline	Move machine to a level surface
	Park or service brake not applied	Apply park or service brake
	Hopper overloaded	Remove debris from hopper
	Engine throttle too low	Increase engine throttle
Machine will not propel	Brake pressure too low	Contact service personnel
	Operator not in seat	Sit in seat
	Parking brake on	Release parking brake
	Directional lever in neutral	Move directional lever in forward or reverse position

MACHINE TROUBLESHOOTING

Problem	Cause	Remedy
Poor sweeping performance	Brush bristles worn	Replace brushes
	Wrong sweeping brush	Contact TENNANT representative for recommendations
	Main, side or vario brushes not adjusted properly	Adjust main, side or vario brushes
	Main, side or vario brush drive failure	Contact TENNANT service personnel
	Debris caught in main brush drive mechanism or conveyor	Free drive mechanism or conveyor of debris
	Conveyor in reverse	Switch conveyor to forward direction
	Conveyor failure	Contact TENNANT service personnel
	Conveyor skirts worn or damaged	Replace conveyor skirts
	Hopper full	Empty hopper
	Hopper not down completely	Lower hopper completely
	Hopper rear door open	Close and latch hopper rear door
	Vacuum wand door closed	Open vacuum wand door
	Vacuum fan not on	Turn vacuum fan on
	Vacuum fan failure	Contact TENNANT service personnel
	Worn brush skids	Replace brush skids
Brush skids not completely down	Check for obstruction then lower skids completely	

MAINTENANCE

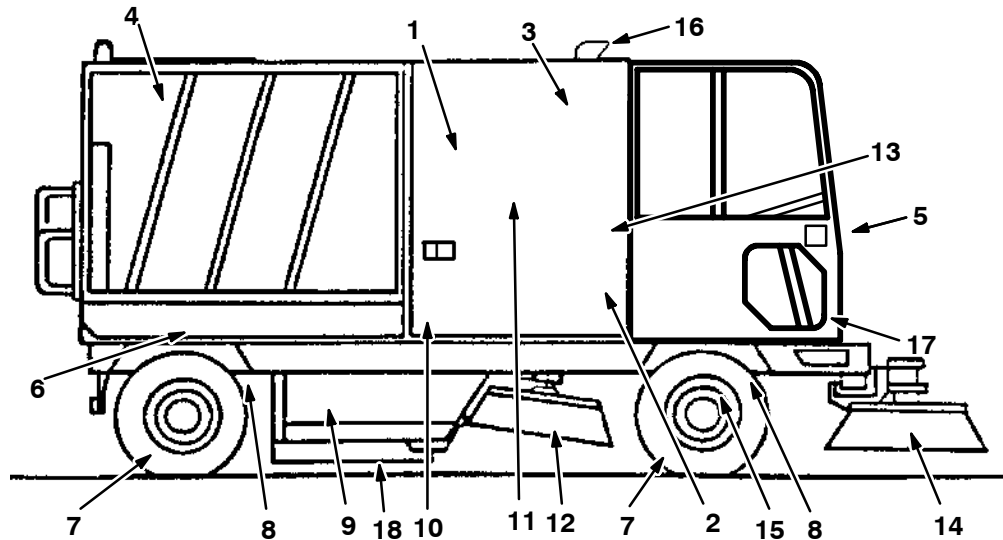

351928

MAINTENANCE CHART

NOTE: Also check procedures indicated () after the first 50-hours of operation.*

Interval	Key	Description	Procedure	Lubricant/ Fluid	No. of Service Points
Daily	10	Conveyor	Check chain tension	-	2
			Lubricate chain	EO	2
			Wash internally	-	1
			Lubricate bearings	WBG	4
	10	Conveyor skirts and paddles	Check for damage and wear	-	All
	16	Engine air intake screen	Check and clean	-	1
	3	Engine crankcase	Check oil level	EO	1
	3	Fuel water separator	Check for water, drain	-	1
	3	Radiator	Check and clean core exterior	-	1
			Check coolant level in overflow reservoir	WG	1
	3	Hydraulic fluid cooler	Check and clean cooler fins	-	1
	3	Air conditioner condenser (option)	Check and clean cooler fins	-	1
	11	Hydraulic fluid reservoir	Check fluid level	HYDO	1
	9	Brush compartment skirts	Check for damage and wear	-	3
			Main brush	Check for damage, wear, and adjustment	-
Check brush pattern			-	1	
12	Side brush(es)	Check for damage and wear	-	1-3	
4	Hopper dust filter	Shake	-	1	
13	Windshield washer reservoir	Check fluid level	WF	1	
50 Hours	3	Fuel lines and clamps	Check for tightness and wear	-	1
	7	Tires	Check pressure	-	4
	8	Steering	Align wheels	-	1
	17	Cab filters	Clean	-	1
	1	Main brush/conveyor lift	Purge hydraulic fluid air	-	1

NOTE: Also check procedures indicated () after the first 50-hours of operation.*

Interval	Key	Description	Procedure	Lubricant/ Fluid	No. of Service Points
100 Hours	9	Brush compartment, conveyor and hopper seals, skid flap	Check for damage or wear	-	All
	3	Engine crankcase	*Change oil and filter element	EO	1
	3	Engine fan belt	Check tension	-	1
	3	Air conditioner belt (option)	Check tension	-	1
	3	Engine air filter	Check the dust cap	-	1
	6	Hopper tilt	Lubricate	WBG	8
	6	Hopper lift (option)	Lubricate	WBG	13
	7	Wheels	Check wheel nut torque	-	4
	9	Main brush support rods	Lubricate	WBG	8
200 Hours	18	Skids	Check for wear	-	2
	3	Radiator hoses and clamps	Check for tightness and wear	-	2
	8	Steering	Lubricate steering cylinder	WBG	2
	8	Suspension	Lubricate leaf springs and pivots	WBG	22
	14	Vario sweeping brush	Lubricate rotation and guides	WBG	2
	12	Side brush(es)	Lubricate pivot	WBG	2
	3	Fuel filter	Replace	-	1
	7	Tires	Check wear and rotate	-	4
	-	Hydraulic hoses	Check for wear and damage	-	All
	2	Battery	*Clean and tighten battery cable connections	-	1
			Check electrolyte level	DW	1
	8	Wet dust control system (option)	Clean water filter	-	1
400 Hours	5	Windshield wiper blades	Check for wear	-	2
	15	Differential	Check oil level	-	1
		Parking brake	Check fluid level	-	1
800 Hours	7	Service brakes	Check fluid level	-	4
	11	Hydraulic reservoir	Replace filler cap and filter element	-	1
			Change hydraulic fluid	HYDO	1
	Hydraulic fluid filter	Change filter element	-	1	
1600 Hours	15	Differential	Change gear lubricant	GL	1
		Parking brake	Change fluid level	UTF	1
	7	Service brakes	Change fluid level	UTF	4
	3	Cooling system	Flush	WG	1

LUBRICANT/FLUID

UTF . . . Universal tractor fluid (Mobil 424)

EO . . . Engine oil, SAE-CD/SE rated

HYDO . TENNANT or approved hydraulic fluid

WBG . . Waterproof bearing grease (TENNANT part no. 765819)

WG . . . Water and permanent-type ethylene glycol anti-freeze, -34° C (-30° F)

DW . . . Distilled water

WF . . . Automotive-type windshield washer fluid

GL . . . SAE 90 weight gear lubricant (Grade GL5)

NOTE: More frequent intervals may be required in extremely dusty conditions.

MAINTENANCE

LUBRICATION

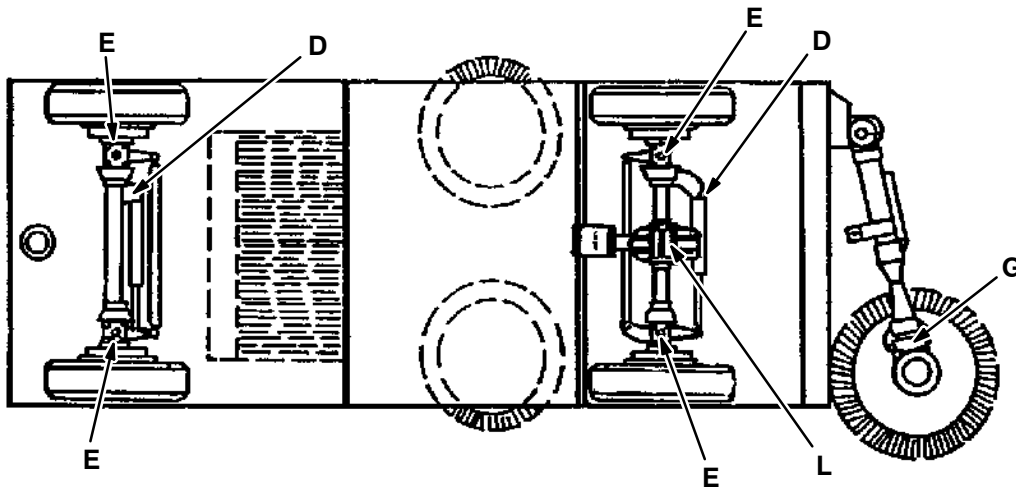
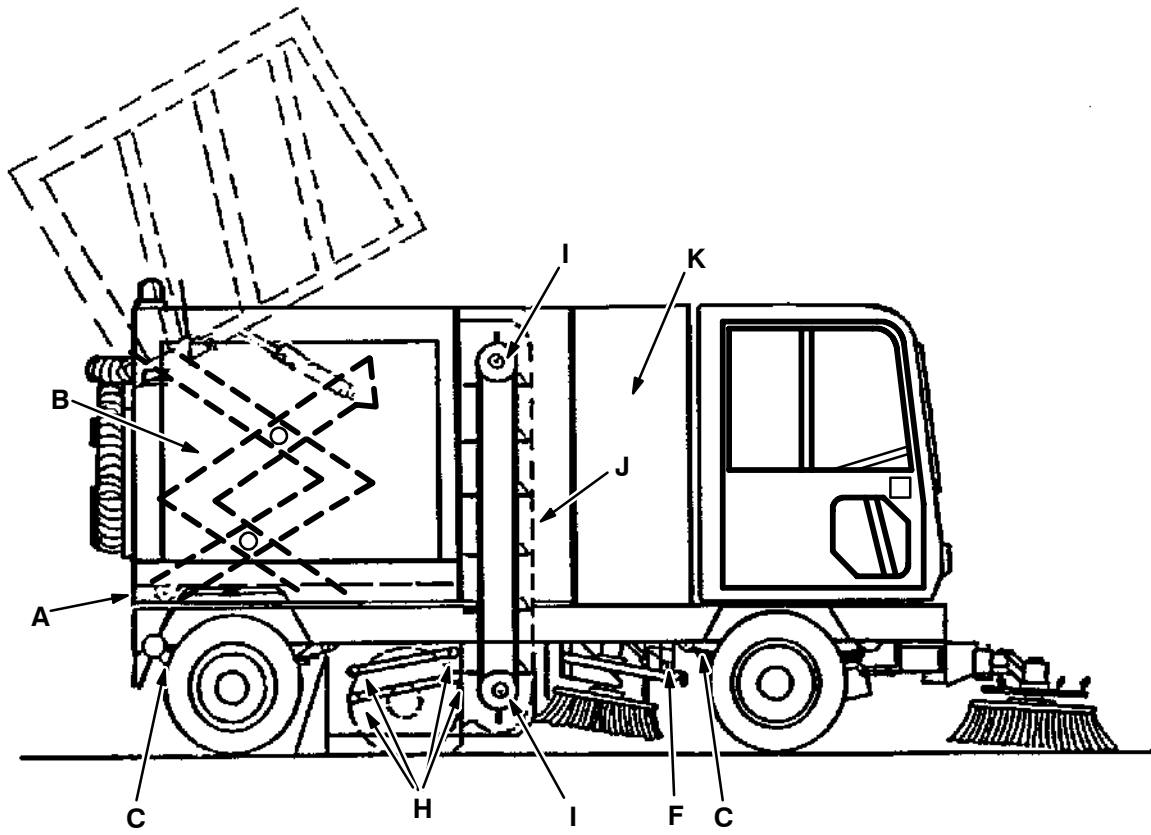

351930

A. HOPPER TILT (LOW DUMP)

The hopper tilt has eight grease fittings. Four grease fittings are located on the tilt cylinders, one on each end of the two cylinders. Two grease fittings are located on the hopper safety support cylinders, one at each end. The last two grease fittings are located at the hopper tilt pivot, one on each side. Lubricate these fittings with Waterproof Bearing grease (TENNANT part no. 765819) after every 100 hours of operation.

**⚠ WARNING: Raised hopper may fall.
Engage hopper support pin.**

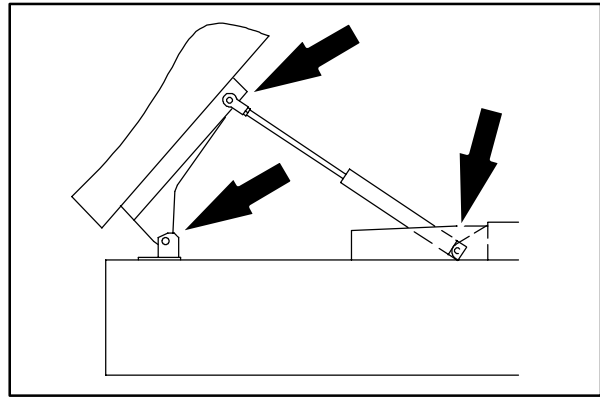

351933

B. HOPPER LIFT/TILT (HIGH DUMP OPTION)

The high dump hopper lift has thirteen grease fittings. Four grease fittings are located on the upper tilt cylinders, one on each end of the two cylinders. Two grease fittings are located on the lower lift cylinders, one at each base. One grease fitting is located at the top of the hopper safety support cylinder. Two grease fittings are located at the hopper tilt pivot, one on each side. The last four grease fittings are located on the cross shaft pivots of the hopper lift arms, one at each of the four pivots. Lubricate these fittings with Waterproof Bearing grease (TENNANT part no. 765819) after every 100 hours of operation.

**⚠ WARNING: Raised hopper may fall.
Engage hopper support bar.**

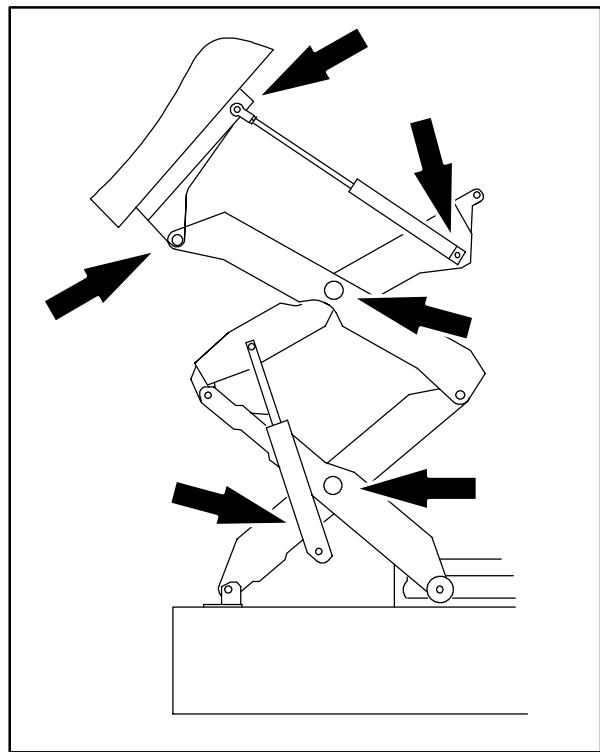

351932

C. AXLE LEAF SPRINGS

The axle leaf springs have twelve grease fittings. Lubricate with Waterproof Bearing grease (TENNANT part no. 765819) after every 200 hours of operation.



MAINTENANCE

D. STEERING CYLINDER

Each steering cylinder has one grease fitting. Lubricate with Waterproof Bearing grease (TENNANT part no. 765819) after every 200 hours of operation.

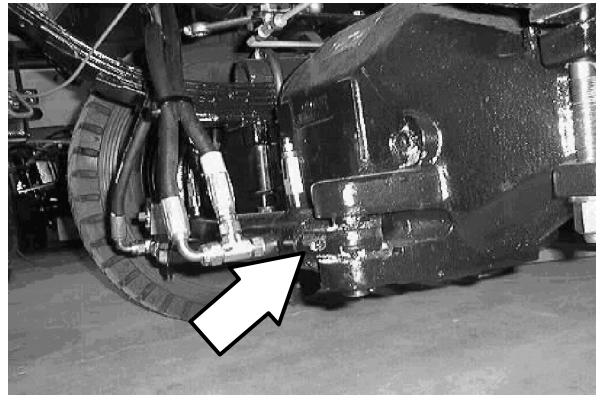

E. WHEEL PIVOTS POINTS

The wheel pivots points have eight grease fittings. Lubricate with Waterproof Bearing grease (TENNANT part no. 765819) after every 200 hours of operation.

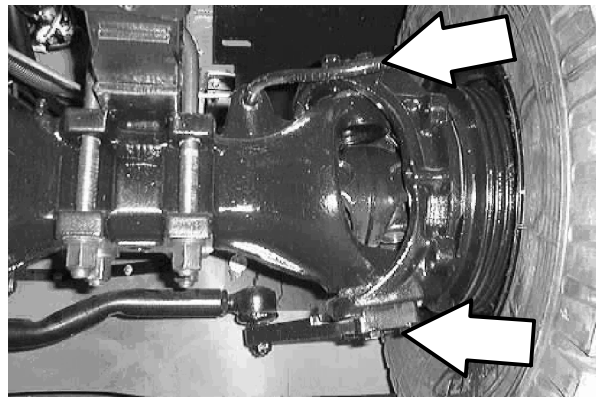

F. SIDE BRUSH PIVOT

Each side brush pivot has a grease fitting. Lubricate with Waterproof Bearing grease (TENNANT part no. 765819) after every 200 hours of operation.

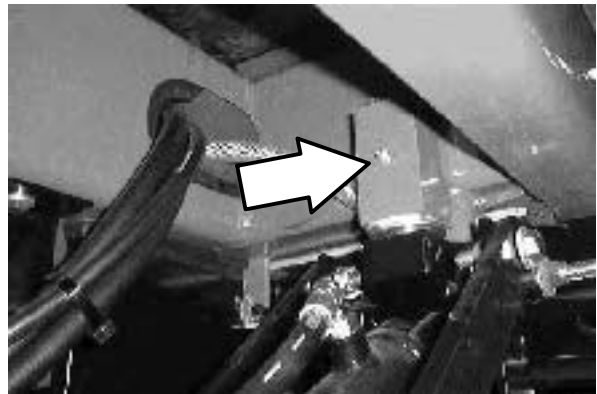

G. VARIO SWEEPING BRUSH™ (OPTION)

The brush pivot has two grease fittings. Lubricate with Waterproof Bearing grease (TENNANT part no. 765819) after every 200 hours of operation.

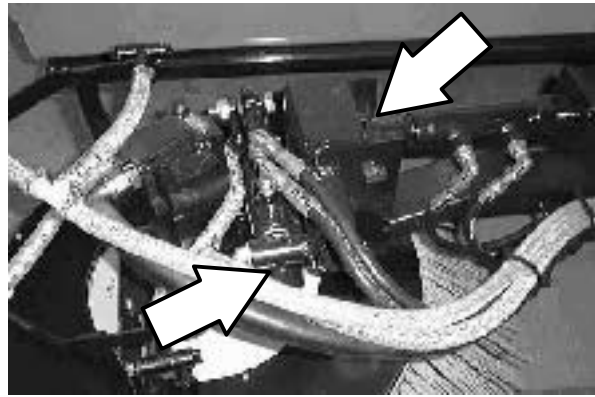

H. MAIN BRUSH SUPPORT RODS

The main brush support rods have a total of eight grease fittings, four on each side. Lubricate with Waterproof Bearing grease (TENNANT part no. 765819) after every 100 hours of operation.

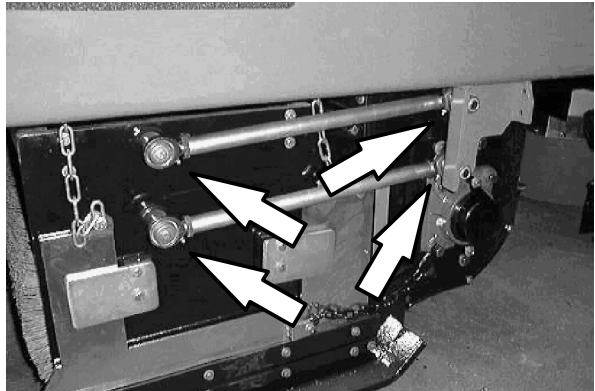

I. CONVEYOR BEARINGS

There are four bearing grease fittings. Lubricate daily with Waterproof Bearing grease (TENNANT part no. 765819).

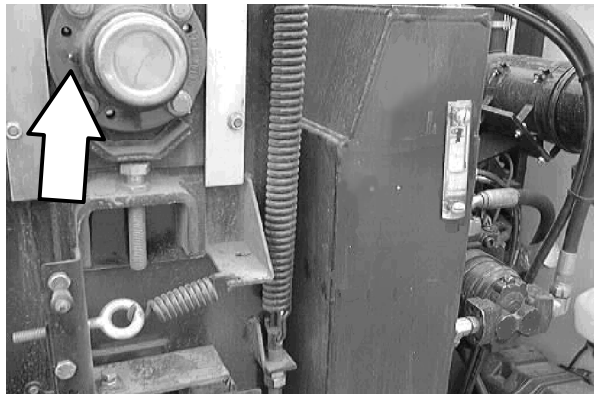

J. CONVEYOR CHAIN

The conveyor chains should be lubricated with engine oil daily.

Remove the access covers on the sides of the conveyor. Run the conveyor in reverse at idle. Oil the chain making sure to lubricate the o-rings on the chain. Put the access covers back on the sides of conveyor.

FOR SAFETY: When servicing machine, avoid moving parts. Do not wear loose jackets, shirts, or sleeves.

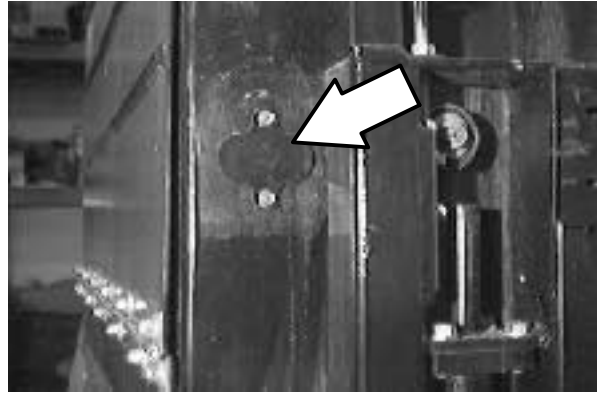

K. ENGINE

Check the engine oil level daily. The engine oil dipstick can be accessed behind the right side engine access door. Change the engine oil and oil filter after every 100 hours of machine operation. Use 10W30 SAE-CD/SE rated engine oil.

The engine oil drain is accessed through the right side door.

Fill the engine with oil to the level indicated on the oil dipstick. The engine oil capacity is 7.6 L (8 qt) including the oil filter.

FOR SAFETY: When servicing machine, avoid moving parts. Do not wear loose jackets, shirts, or sleeves.

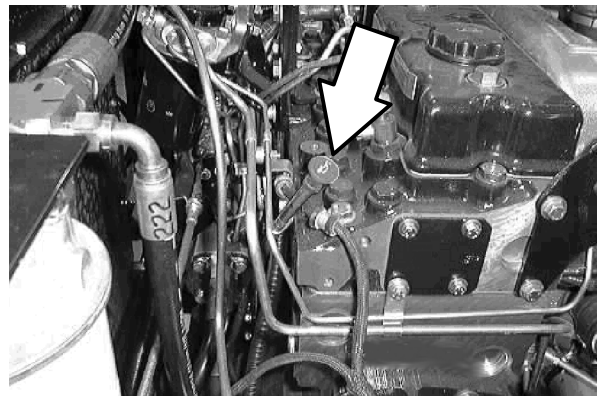

L. DIFFERENTIAL

Check the lubricant level in the differential after every 400 hours of operation by removing the filler plug.

Change the differential lubricant after every 1600 hours of operation. Use SAE 90 weight gear lubricant.

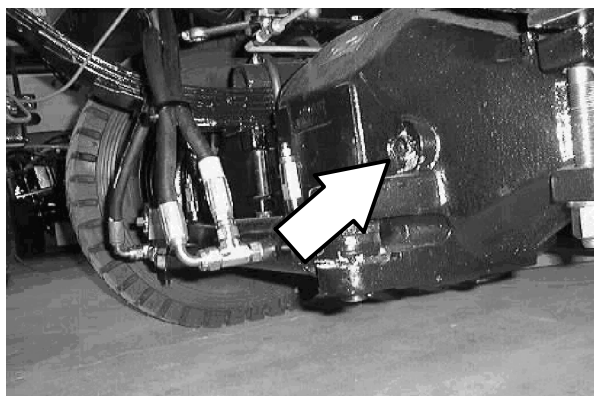

HYDRAULICS

HYDRAULIC FLUID RESERVOIR

The reservoir is located on the right side of the machine next to the engine.

Check the hydraulic fluid level at *operating temperature* daily. Make sure the hopper is down when checking hydraulic fluid level. The sight gauge is marked with full, the black line, and add, the red line, levels to indicate the level of hydraulic fluid in the reservoir. Cold fluid level is mid-point of add and full lines.

ATTENTION! Do not overfill the hydraulic fluid reservoir or operate the machine with a low level of hydraulic fluid in the reservoir. Damage to the machine hydraulic system may result.

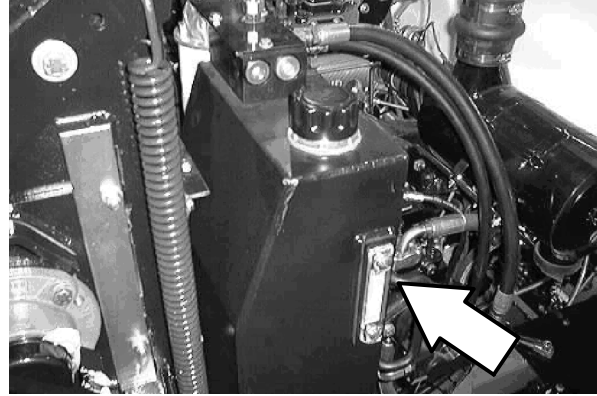

Drain and refill the hydraulic fluid reservoir with new hydraulic fluid every after every 800 hours of operation.

Mounted on top of the reservoir is a filler cap with a built-in breather. Replace the cap after every 800 hours of operation.

Lubricate the filler cap gasket with a film of hydraulic fluid before putting the cap back on the reservoir.

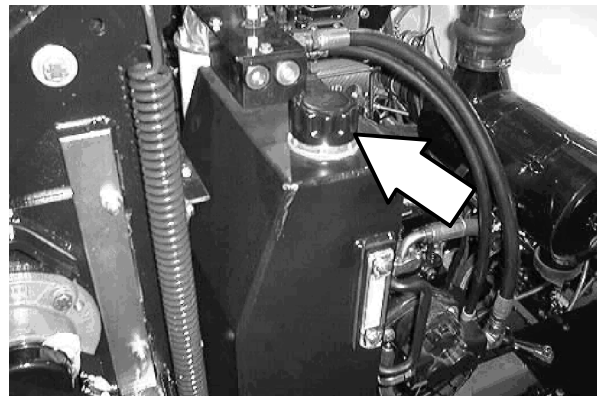

The hydraulic fluid filter is located on the rear side of the hydraulic reservoir near the center of the machine.

Replace the filter element after every 800 hours of operation.

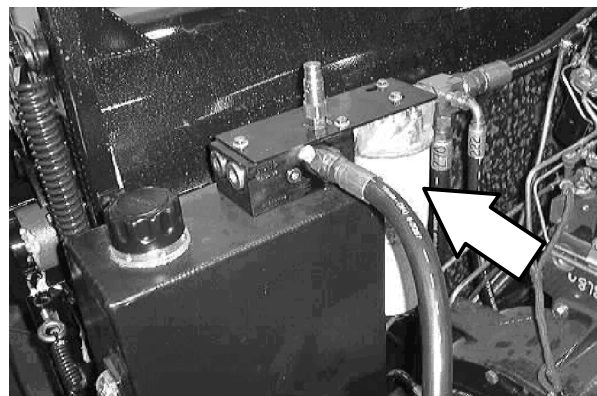

MAINTENANCE

HYDRAULIC FLUID

The quality and condition of the hydraulic fluid play a very important role in how well the machine operates. TENNANT's hydraulic fluid is specially selected to meet the needs of TENNANT machines.

TENNANT's hydraulic fluids provide a longer life for the hydraulic components. There are two TENNANT fluids available for different temperature ranges:

TENNANT part no.	Ambient Temperature
65870 (Mobil no. DTE13M)	above 0° C (32° F)
74217 (Mobil no. DTE11M)	below 0° C (32° F)

The higher temperature fluid has a higher viscosity and should not be used at the lower temperatures. Damage to the hydraulic pumps may occur because of improper lubrication.

The lower temperature fluid is a thinner fluid for colder temperatures.

If a locally-available hydraulic fluid is used, make sure the specifications match TENNANT hydraulic fluid specifications. Using substitute fluids can cause premature failure of hydraulic components.

ATTENTION! Hydraulic components depend on system hydraulic fluid for internal lubrication. Malfunctions, accelerated wear, and damage will result if dirt or other contaminants enter the hydraulic system.

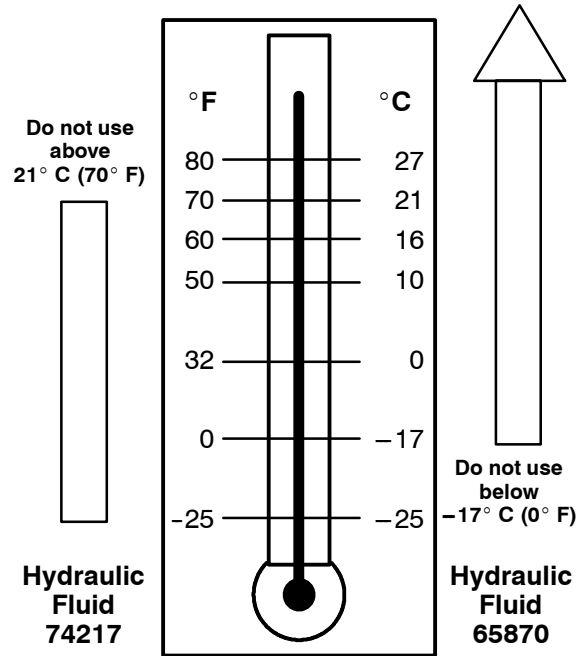

HYDRAULIC HOSES

Check the hydraulic hoses every 200 hours of operation for wear or damage.

Fluid escaping at high pressure from a very small hole can be almost invisible, and can cause serious injuries.

See a doctor at once if injury results from escaping hydraulic fluid. Serious infection or reaction can develop if proper medical treatment is not given immediately.

FOR SAFETY: When servicing machine, use cardboard to locate leaking hydraulic fluid under pressure.

If you discover a fluid leak, contact your mechanic/supervisor.

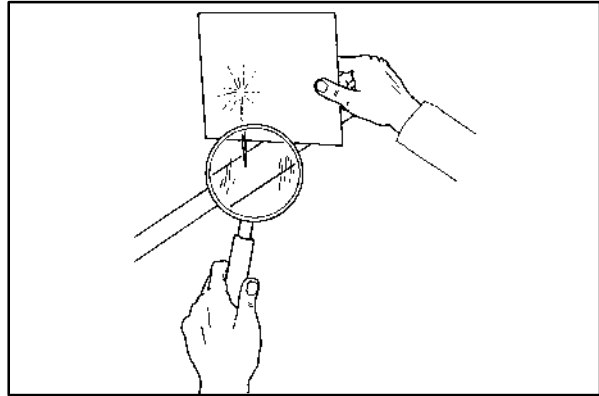

00002

PURGING AIR FROM THE HYDRAULIC CONVEYOR LIFT SYSTEM

When the machine has been used for some time, air can get trapped in the hydraulic fluid and cause the conveyor lift cylinder to slowly leak down from the raised position. If a hydraulic component in the lift system has been replaced, air will get into the hydraulic fluid. This air must be purged from the system. The conveyor lift cylinders have a built-in feature called *re-phasing* that allows the air trapped in the system to escape. When the conveyor lift cylinders are at the top of their stroke, tiny bleed holes in the cylinder are exposed allowing the air to escape.

Purge air from the hydraulic system after every 50 hours of operation, after a hydraulic component in the lift system has been changed, or if the conveyor/main brush system slowly lowers. To purge air from the hydraulic system, place the throttle in the idle position. With the sweep system down and on, press and hold the *sweep switch* again to raise and turn off the sweep system. Hold in this position for up to 5 minutes or until the air is forced from the system.

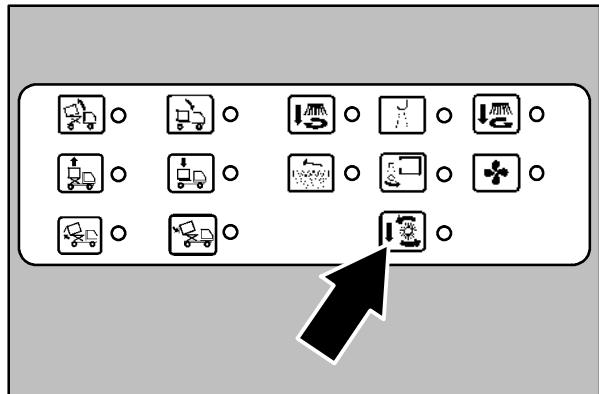

351926

ENGINE

COOLING SYSTEM

Check the radiator coolant level daily in the overflow reservoir. Use clean water mixed with a permanent-type, ethylene glycol antifreeze to a -34°C (-30°F) rating. Add coolant to the overflow reservoir.

FOR SAFETY: When servicing machine, avoid contact with hot engine coolant.



Check the radiator hoses and clamps every 200 hours of operation. Tighten the clamps if they are loose. Replace the hoses and clamps if the hoses are cracked, harden, or swollen.

Check the radiator core exterior and hydraulic cooler fins for debris daily. If the machine is equipped with air conditioning, check the condenser as well. The condenser hinges out for cleaning. Blow or rinse all dust, which may have collected on the radiator or condenser, in through the grille and radiator fins, opposite the direction of normal air flow. Be careful not to bend the cooling fins when cleaning. Clean thoroughly to prevent the fins becoming encrusted with dust. Clean the radiator, cooler, and condenser only after they have cooled to avoid cracking.

FOR SAFETY: When using pressurized air or water, wear eye and ear protection.

ATTENTION! Do not wash the fuel injection pump or turbocharger when the engine is running or warm. This could damage these components.

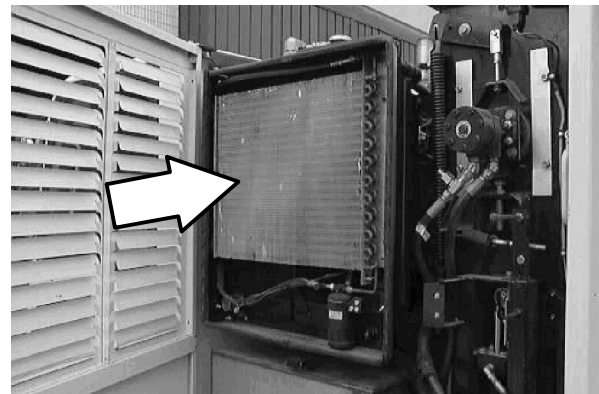

Flush the radiator and the cooling system every 1600 hours of operation, using a dependable cleaning compound.

The radiator and hydraulic cooler assembly pivots forward for cleaning or for accessing the front of the engine. To pivot forward, unscrew the bottom two bolts, pull the assembly forward and engage the locking latch.

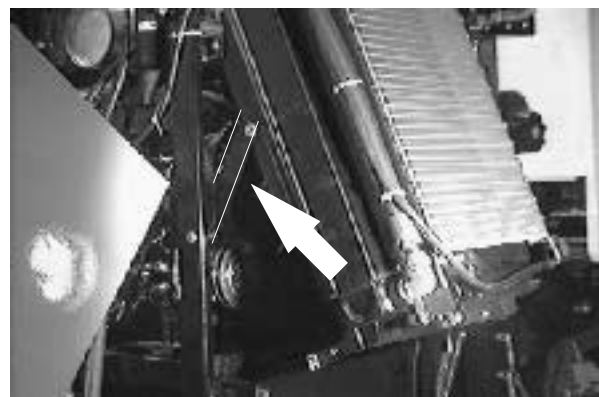

AIR FILTER

The engine air filter housing has an end cap, a rubber dust cap and a dry cartridge-type air filter element. Check the dust cap every 100 hours of operation to make sure it is expelling dust. Replace the dust cap if the rubber is worn.

The air filter element must be replaced whenever it is damaged. Inside the air filter element is a safety element. Replace this element, do not clean it, after the regular element has been damaged or changed three times.

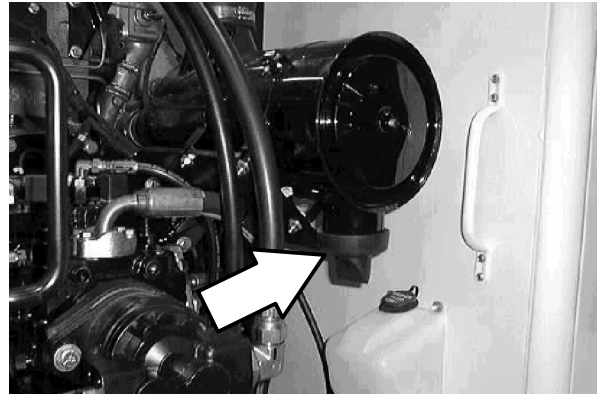

Replace the air filter element only when the *clogged engine air filter light* shows restriction in the air intake system. Do not remove the air filter element from the housing unless it is restricting air flow.

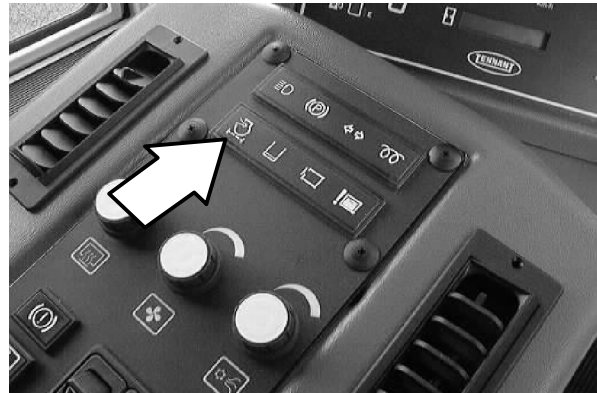

On standard engines, install the end cap on the air filter housing with the rubber dust cap facing downward. On turbo engines, the dust cap is on the housing.

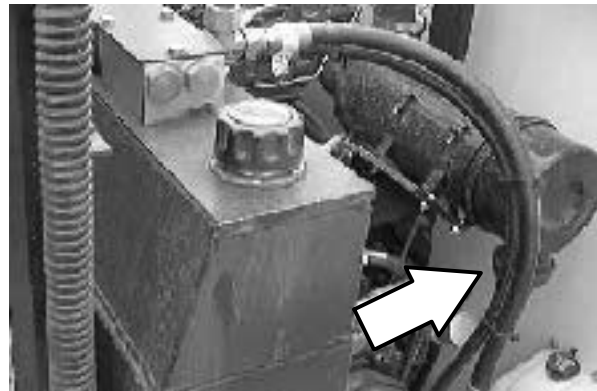

MAINTENANCE

AIR INTAKE SCREEN

Check the *air intake screen* for obstructions daily. It is located on top of the engine air cleaner.

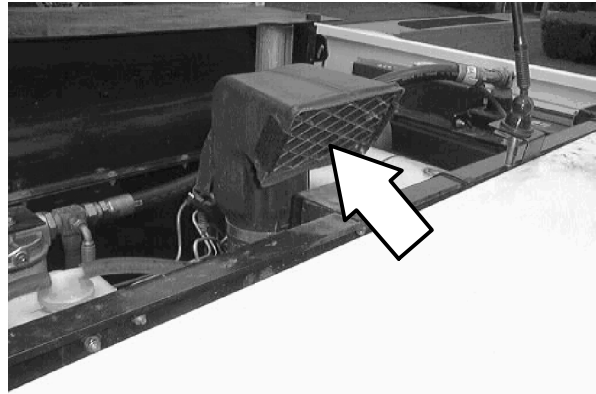

FUEL FILTER

The *fuel filter* has an element that filters impurities from the diesel fuel. It is located on the conveyor side of the engine.

Replace the fuel filter element after every 200 hours of operation.

FOR SAFETY: Keep flames and sparks away from fuel system service area. Keep area well ventilated.

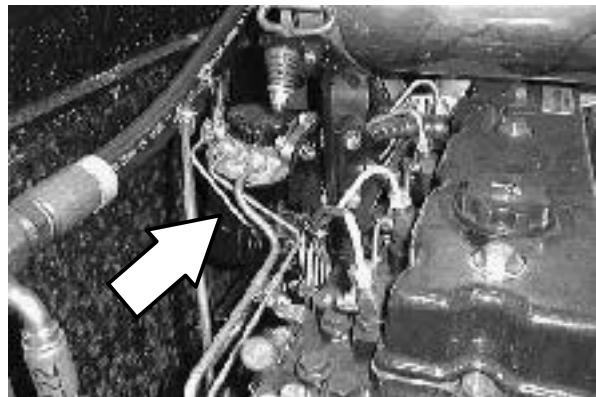

FUEL WATER SEPARATOR

The *fuel water separator* separates water from the diesel fuel. It is located on the right side of the machine in the engine compartment.

Check the fuel water separator bowl daily for water. Drain any water visible in the bowl.

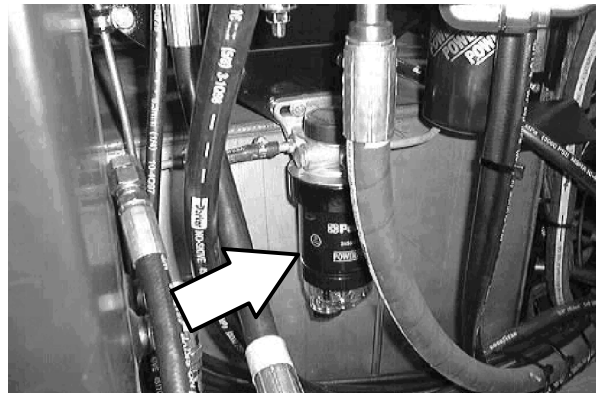

FUEL LINES

Check the fuel lines every 50 hours of operation. If the clamp band is loose, apply oil to the screw of the band, and securely tighten the band.

Made of rubber, the fuel lines may become worn out whether the engine has been used much or not. Replace the fuel lines and clamp bands every two years.

FOR SAFETY: Keep flames and sparks away from fuel system service area. Keep area well ventilated.

If the fuel lines and clamp bands are found worn or damaged before two years' time, replace or repair them at once. Bleed the fuel system after replacement of any of the fuel lines, see *TO PRIME THE FUEL SYSTEM*. When the fuel lines are not installed, plug both ends with clean cloth or paper to prevent dirt from entering the lines. Dirt in the lines can cause fuel injection pump malfunction.

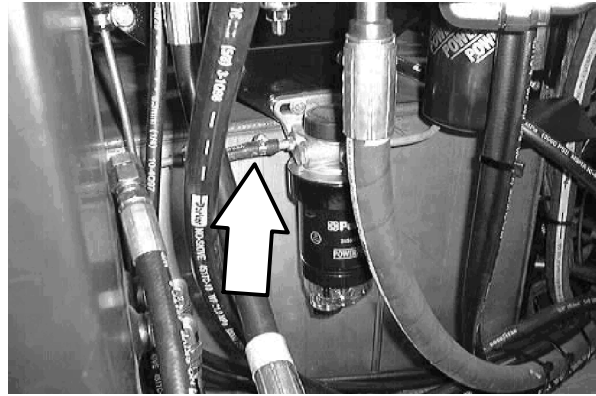

PRIMING FUEL SYSTEM

Priming the fuel system removes pockets of air in the fuel lines and fuel components. Air in the fuel system will prevent smooth engine operation.

Prime the fuel system after running out of fuel, changing the fuel filter, disconnecting the low pressure fuel lines, or any part of the low pressure fuel system leaks during engine operation.

TO PRIME FUEL SYSTEM

1. Stop the engine and set the machine parking brake.

FOR SAFETY: Before leaving or servicing machine, stop on level surface, set parking brake, and turn off machine. Keep flames and sparks away from fuel system service area. Keep area well ventilated.

2. Fill the fuel tank.

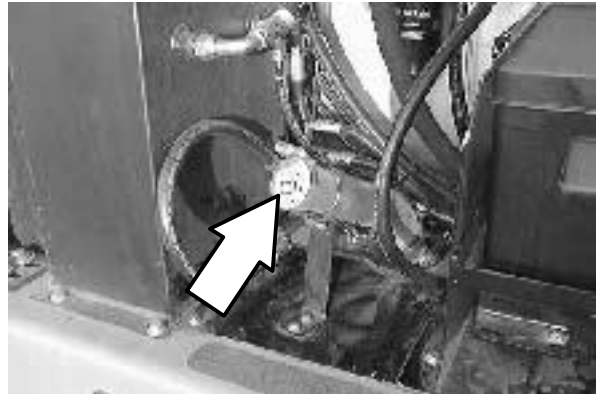

3. Manually operate the priming pump until fuel, free from air, comes from the filter vent point.

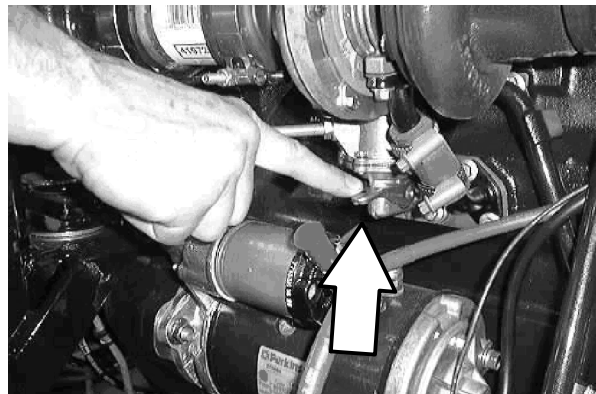

4. Loosen the return connection of the fuel injection pump.

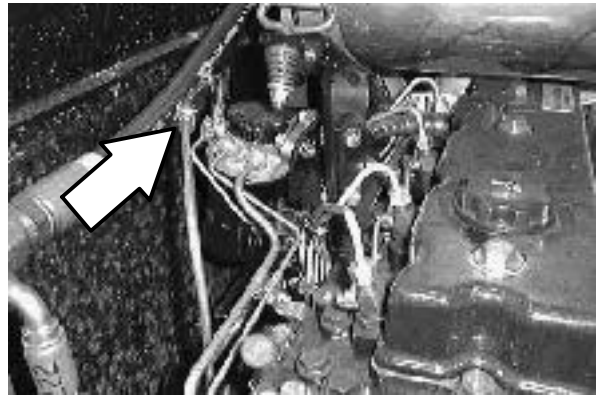

5. Operate the priming pump until fuel, free from air, comes from the injection pump vent point.
6. Loosen all four of the high pressure fuel line connections at the injectors.

ATTENTION! The engine may start running spontaneously if all four of the fuel line connections are not loosened.

7. Operate the starter motor until fuel, free from air, comes from the line connections.

NOTE: Operating the throttle in the Fast position will increase the fuel flow speedup the bleeding process. After bleeding is finished, return the throttle to Idle.

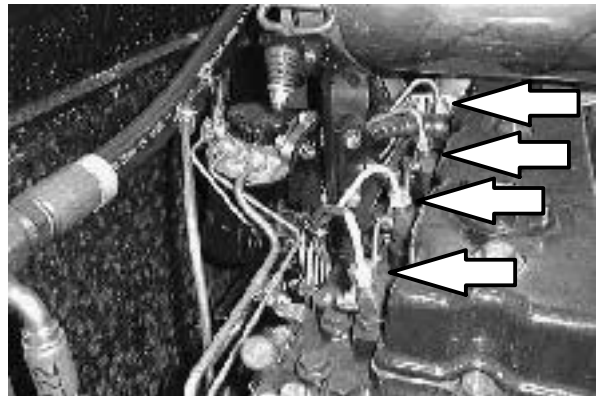

8. Tighten the high pressure fuel line connections. The engine is now ready to start.

NOTE: If the engine runs correctly for a short time and then stops, or runs roughly, check for air in the fuel system. If there is air in the system, there is probably leakage in the low pressure system.

9. Turn the ignition switch off.

CAB FILTERS

The fresh air cab filters are located in the front of the cab. Clean these filters with soap and water. Check and clean the cab filters after every 50 hours of operation. Replace when necessary.

 **WARNING: Brush linkage pinch points. Stay clear when linkage is moving.**

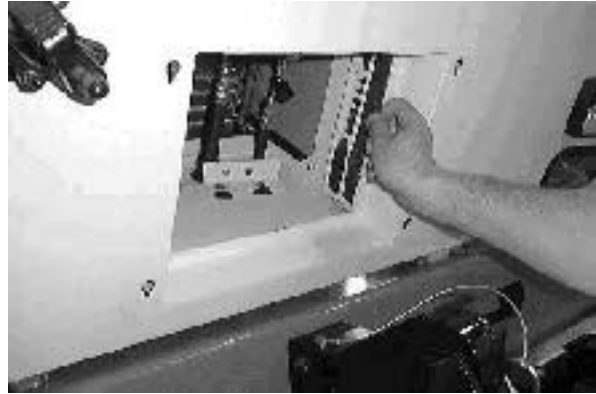

WET DUST CONTROL FILTER (OPTION)

The wet dust control filter is located under the cab between the front wheels.

Clean the water filter every 200 hours of operation by removing it and flushing it with clean water.

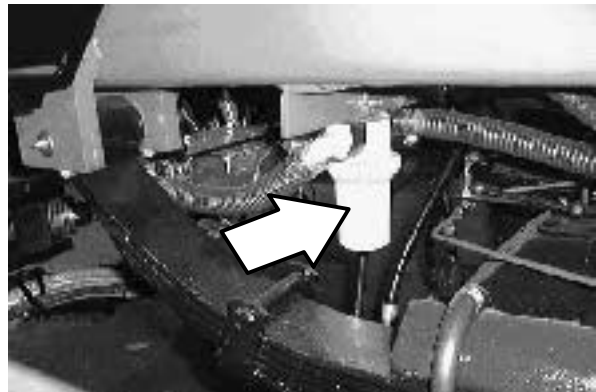

WINDSHIELD WIPER BLADES

Check the windshield wiper blades for wear every 200 hours of operation. Replace when necessary.



WINDSHIELD WASHER FLUID

The windshield washer fluid is located behind the operator cab and can be accessed through the right engine access door. Check the windshield washer fluid level daily. Fill with automotive-type windshield washer fluid.



BATTERY

The battery is located behind the operator cab and can be accessed through the right engine access door.

After the first 50 hours of operation, and every 200 hours after that, clean and tighten the battery connections.

Check the electrolyte level every 200 hours of operation. Only add distilled water.

FOR SAFETY: When servicing machine, avoid contact with battery acid. Wear eye and ear protection.

NOTE: When the battery is disconnected, the parking brake will come on automatically.

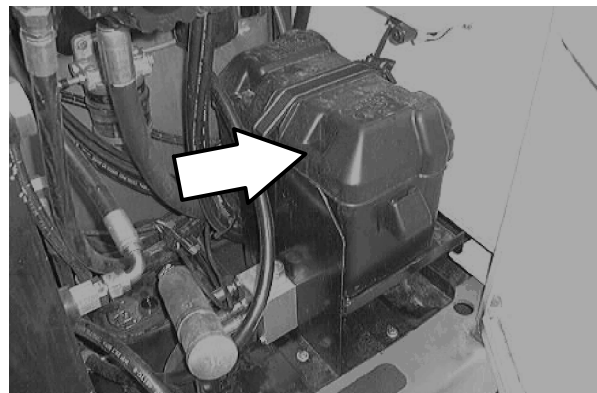

BELTS AND CHAINS

ENGINE BELT

The engine fan belt is driven by the engine crankshaft pulley and drives the alternator pulley. Proper belt tension is 10 mm (0.40 in) from a force of 4 to 5 kg (8 to 10 lb) applied at the mid-point of the longest span.

Check and adjust the belt tension every 100 hours of operation.

FOR SAFETY: When servicing machine, avoid moving parts. Do not wear loose jackets, shirts, or sleeves.

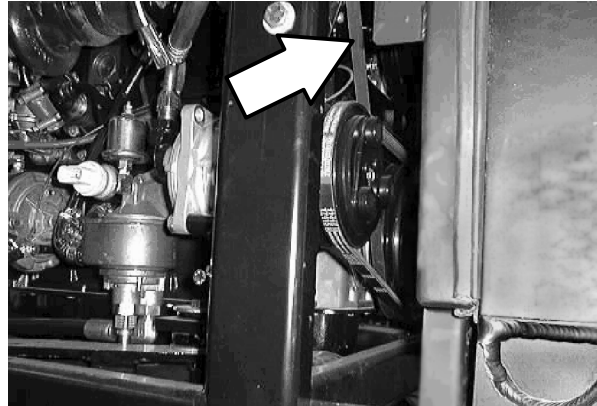

AIR CONDITIONER BELT (OPTION)

The air conditioner belt is driven by the engine crankshaft pulley and drives the compressor. Proper belt tension is 4 mm (0.19 in) from a firm force of a finger applied at the mid-point of the longest span.

Check and adjust the belt tension after the first 10 hours of operation and then every 100 hours after that.

FOR SAFETY: When servicing machine, avoid moving parts. Do not wear loose jackets, shirts, or sleeves.

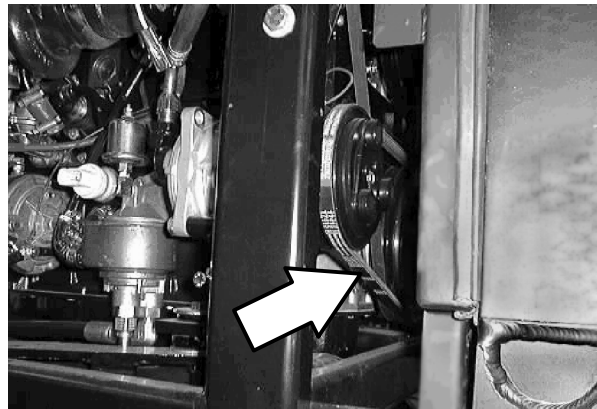

STATIC DRAG CHAIN

A static drag chain prevents the buildup of static electricity in the machine. The chain is attached to the machine at the rear main brush skirt.

Make sure the chain is touching the floor at all times.

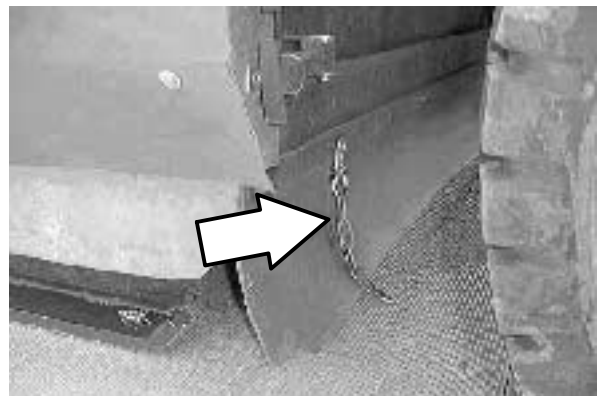

DEBRIS HOPPER

HOPPER DUST FILTER

The hopper dust filter filters the air pulled up from the hopper. The dust filter is equipped with a shaker to remove the accumulated dust particles. To clean the dust filter, with the engine in the idle position, press the *filter shaker switch*.

Shake the dust filter before tilting or dumping the hopper and at the end of every work shift. When sweeping in dusty conditions, shake the filter more often.

TO REMOVE OR REPLACE HOPPER DUST FILTER

1. Stop the engine and set the machine parking brake.

FOR SAFETY: Before leaving or servicing machine, stop on level surface, set parking brake, turn off machine and remove key.

2. Remove the top hopper cover.
3. Remove the nuts holding the filter shaker frame in the hopper.
4. Pull the filter shaker frame and filter out of the hopper.
5. Drill out the rivets holding the filter to the shaker frame.
6. Put the new separators into the new filter bag pockets.
7. Take the rods out of the old filter, and put them in the new filter.

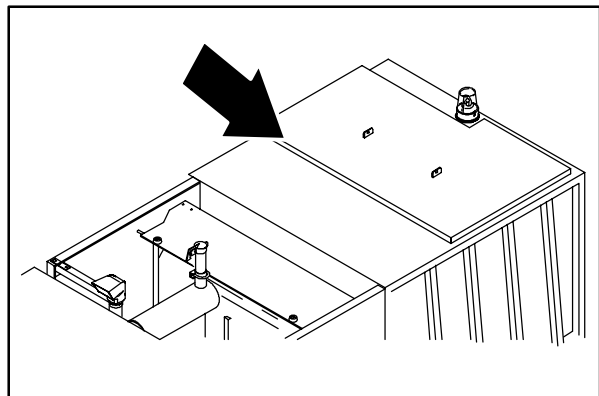

351931

MAINTENANCE

8. Put the filter into the shaker frame.
9. Stretch the filter over the edges of the shaker frame. Pull the drawstring tight.
10. Drill and rivet the filter to the shaker frame.
11. Put the filter shaker frame and filter in the hopper.
12. Install the retaining nuts for the filter shaker frame and tighten.
13. Check the seals on the top hopper cover and the hopper. Replace any that is worn or damaged.
14. Put the top hopper cover back on the hopper. Make sure the cover has a good seal before tightening the hardware.

THERMO SENTRY™

The Thermo Sentry™ senses the temperature of the air pulled up from the hopper. If there is a fire in the hopper, the Thermo Sentry™ stops the vacuum fan and cuts off the air flow. The Thermo Sentry™ is located at the rear of the hopper.

Remove the access panel above the hopper door. Reset the Thermo Sentry™ by pushing in its reset button.



CONVEYOR

The conveyor transports debris picked up by the main brush to the hopper, by means of a paddle system.

Check tension, clean, and lubricate the conveyor chain tensions daily. To lubricate, refer to the *Conveyor Chain* section of this manual. The conveyor chain is tensioned automatically by the springs. However, the tensioner stop bolt must be kept snug to the bottom of the bearing housing. Do not overtighten this adjustment, or premature wear of the chain may result.

Check the conveyor skirts and paddles for damage and wear daily.

 **WARNING: Conveyor throws debris. Conveyor pinch point. Stay clear when in operation.**

Clean the conveyor daily. To do this, tilt the hopper back and run the conveyor in the reverse direction with the throttle in the idle position. Stand next to the machine and spray water through the top conveyor opening across the paddles.

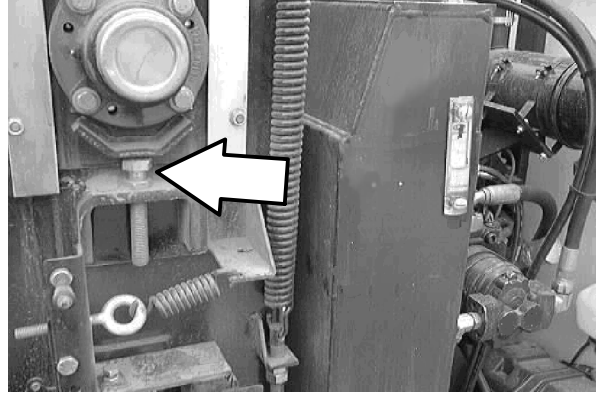

BRUSHES

MAIN BRUSH

The main brush is cylindrical and spans the width of the machine, sweeping debris into the conveyor, which deposits the debris into the hopper.

Check the brush daily for wear or damage. Remove any string or wire tangled on the main brush, main brush drive hub, or main brush idler hub.

Check the main brush pattern daily. The pattern should be 100 to 125 mm (4 to 5 in) wide. Adjust the main brush pattern with the main brush down pressure nut located under the hopper.

Replace the main brush when the remaining bristles measure 50 mm (2 in) in length.

TO REPLACE MAIN BRUSH

1. Park the machine on level ground and set the machine parking brake.
2. Press the *sweep switch* to lower the main brush.

3. Stop the engine.

FOR SAFETY: Before leaving or servicing machine, stop on level surface, set parking brake, turn off machine and remove key.

4. Remove the right side main brush access door.

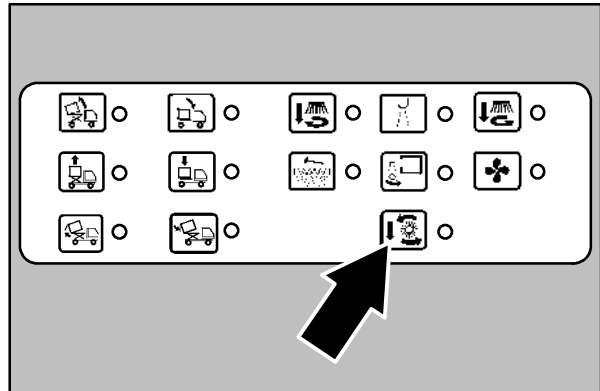

351926

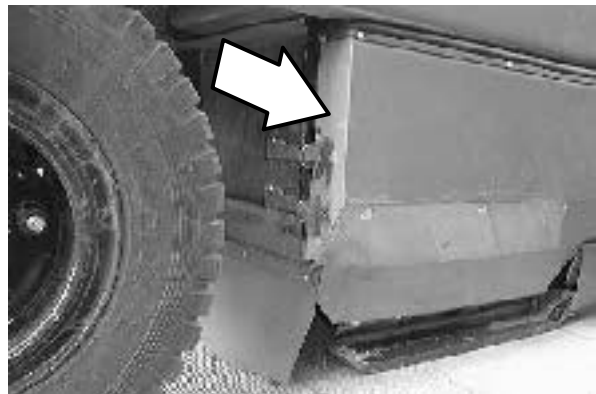

5. Remove the hardware holding the skid plates to the brush idler plate.

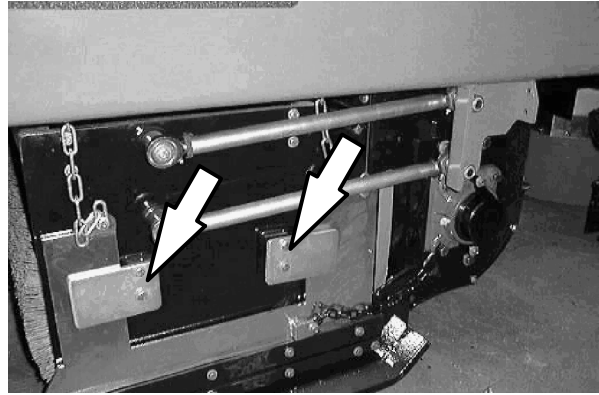

6. Remove the hardware holding the links to the brush idler plate.

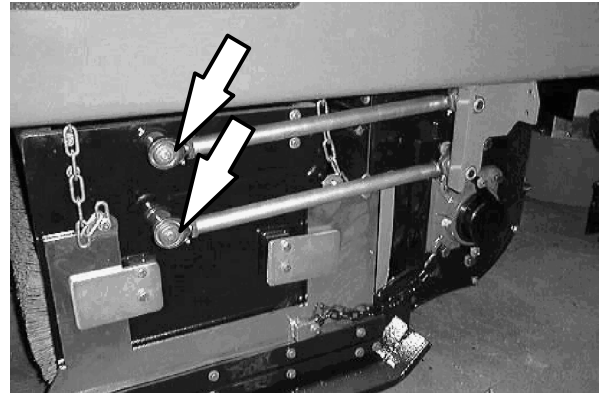

7. Remove the brush chains and the skid chain.

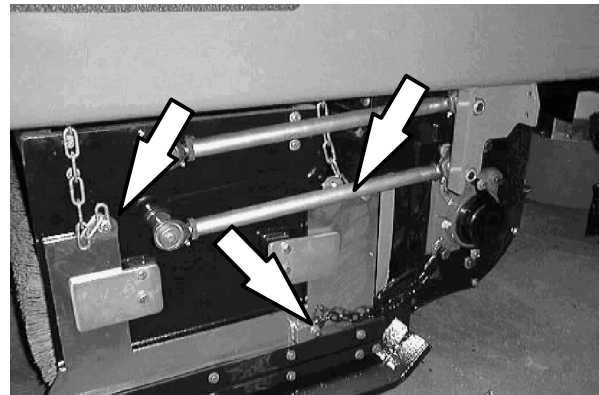

MAINTENANCE

8. Remove the hardware holding the idler plate onto the machine.
9. Remove the brush idler plate.
10. Grasp the main brush; pull it off the brush drive plug and out of the main brush compartment.
11. Put the new brush on the ground next to the access door.
12. Slide the main brush onto the drive plug. Rotate the brush until it engages the drive plug, and push it all the way onto the plug.
13. Slide the main brush idler plate plug onto the main brush.
14. Mount the idler plate onto the machine with the hardware removed earlier.
15. Mount the brush chains and the skid chain.
16. Mount the links to the idler plate with the hardware removed earlier.
17. Mount the skid plates to the idler plate with the hardware removed earlier.
18. Put the right side main brush access door back on the machine.
19. Check and adjust the main brush pattern.

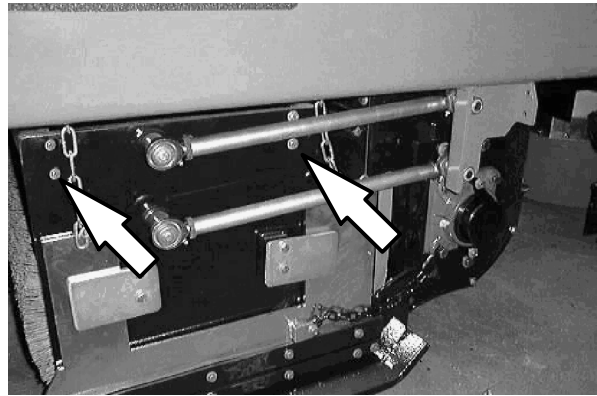

TO CHECK AND ADJUST MAIN BRUSH PATTERN

1. Park the machine on level ground and set the machine parking brake.
2. Press the *sweep switch* to lower and start the main brush. Allow the brush to rotate in one place for 2 minutes.

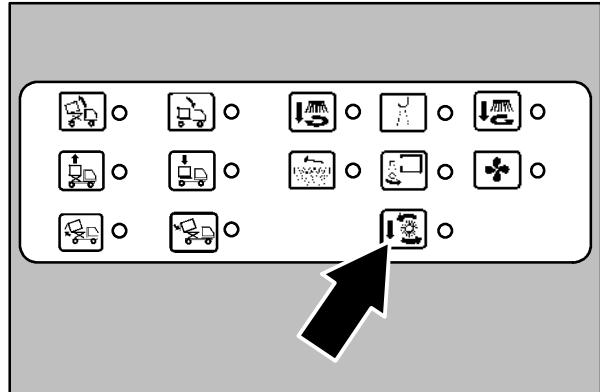

351926

3. Press the *sweep switch* again to raise and stop the main brush.
4. Drive the machine off the test area.
5. Observe the width of the brush pattern. The proper brush pattern width is 100 to 125 mm (4 to 5 in).
6. To increase the width of the main brush pattern, turn the main brush down pressure nut counter-clockwise.

To decrease the width of the main brush pattern, turn the main brush down pressure nut clockwise.

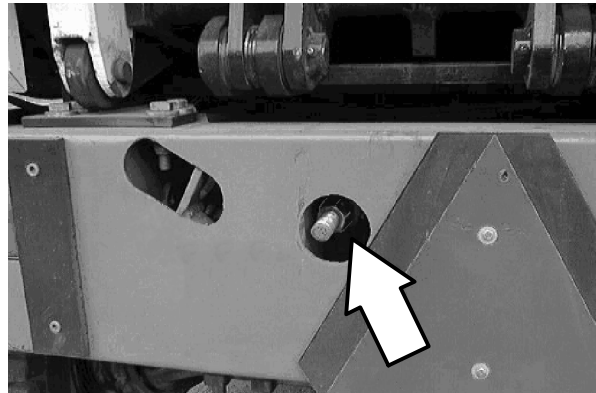

SIDE BRUSH

The side brush sweeps debris along edges into the path of the main brush.

Check the brush daily for wear or damage. Remove any string or wire found tangled on the side brush or side brush drive hub.

The side brush pattern is set at the factory.

The side brush should be replaced when it no longer sweeps effectively for your application. A guideline length is when the remaining bristles measure 75 mm (3 in) in length. You may change the side brush sooner if you are sweeping light litter, or wear the bristles shorter if you are sweeping heavy debris.

TO REPLACE SIDE BRUSH

1. Raise and stop the side brush.
2. Stop the engine and set the machine parking brake.

FOR SAFETY: Before leaving or servicing machine, stop on level surface, set parking brake, turn off machine and remove key.

3. Remove the side brush retaining hardware holding the brush to the drive hub.



WARNING: Side brush can move. Do not step on side brush.

4. Mount the new side brush to the drive hub with the hardware removed earlier.

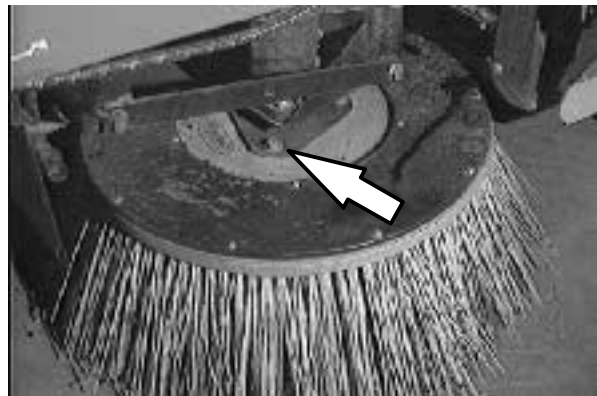

SKIRTS AND SEALS

BRUSH ACCESS DOOR SKIRTS

The brush access door skirts are located on the bottom and front of each of the two main brush access doors. The bottom skirts should touch the skid plates on either side of the machine.

Check the skirts for wear or damage daily.

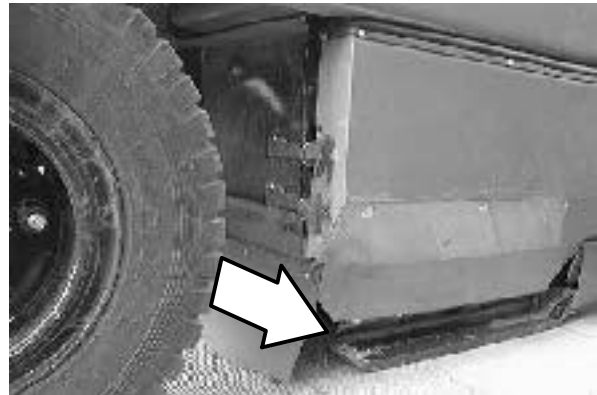

BRUSH COMPARTMENT REAR SKIRT

The brush compartment skirt is located at the rear of the brush compartment. The skirt should clear the ground by 3 mm (0.125 in).

Check the skirt for wear or damage daily.

NOTE: Tire pressure and a full hopper will affect skirt clearances.

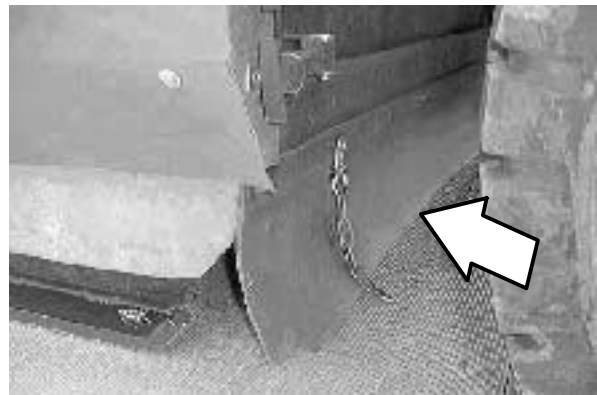

CONVEYOR SKIRTS

The conveyor has a lip skirt located at the bottom rear of the conveyor and two side skirts. The skirts should touch the ground when the conveyor is lowered into the sweeping position.

Check the skirts for wear or damage daily.

Replace the skirts when they no longer touch the ground.

NOTE: Tire pressure and a full hopper will affect skirt clearances.

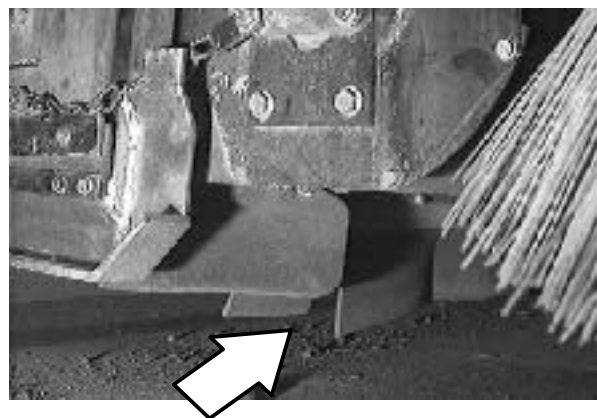

MAINTENANCE

DOOR SEALS

The brush access doors and the cab doors have seals located along their door edges.

Check the seals for wear or damage every 100 hours of operation.

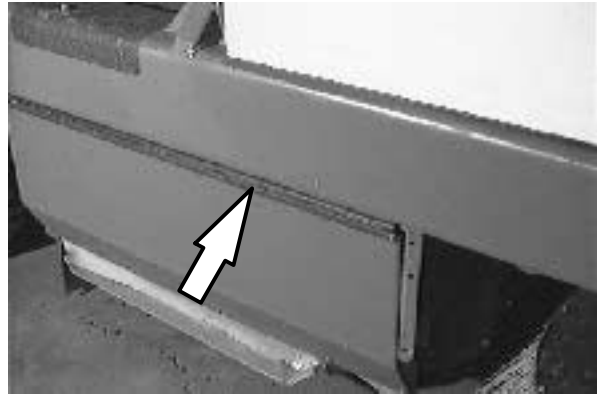

CONVEYOR SEALS

The conveyor seals are located on the machine frame where the conveyor makes contact with the frame.

Check the seals for wear or damage every 100 hours of operation.



HOPPER SEALS

The hopper seals are located on the hopper door, the hopper filter cover, the dust filter, and the front opening of the hopper.

Check the seals for wear or damage every 100 hours of operation.

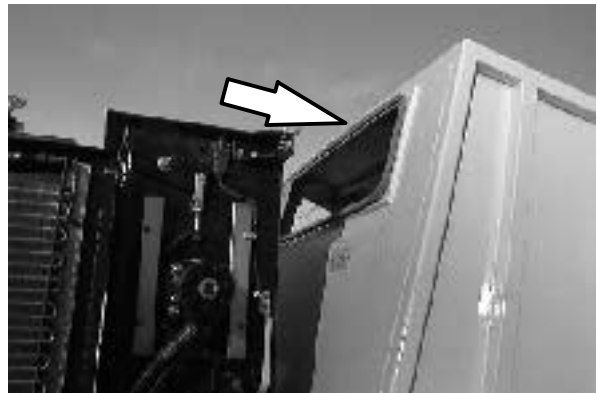

SKIDS

SKIDS

The skids are located on either side of the brush compartment. They skim the ground when the conveyor is lowered into the sweeping position and are designed to contain debris between the main brush and the conveyor lip.

Check the skids for wear after every 100 hours of operation. The skids should be replaced when the thickness is less than 1 mm (0.04 in).

The skids are attached to the upper plate by means of a rubber flap which absorbs shock. Check the rubber flaps every 100 hours of operation for damage or wear.

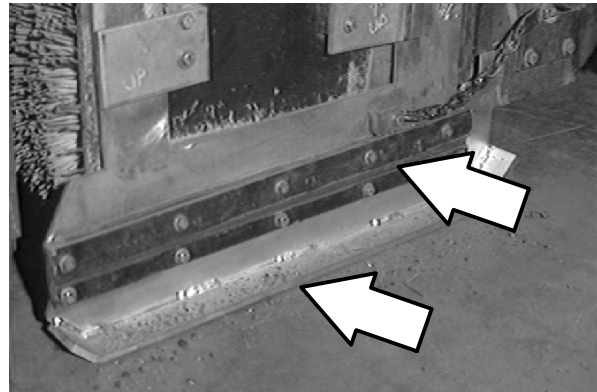

BRAKES AND TIRES

SERVICE BRAKES

This machine is equipped with wet multi-disc service brakes located on all four wheels. These brakes are filled with universal tractor fluid (Mobil 424). The fill/check ports are located on the side of the wheel hubs. The drain ports are located on the bottom of the wheel hubs. The fluid level should be checked after every 400 hours of operation. Change the fluid after every 1600 hours of operation.

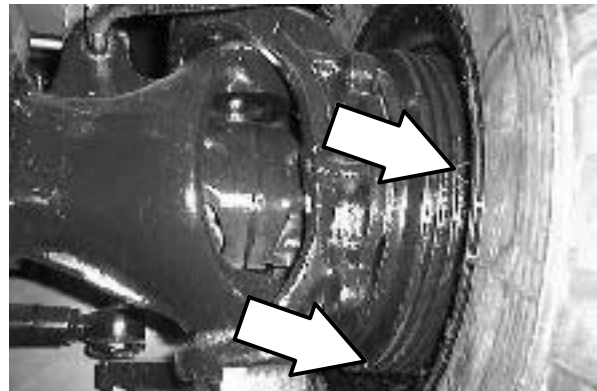

PARKING BRAKE

The parking brake is set with the *parking brake switch*. The wet multi-disc brake unit is located between the differential and the propelling motor and is filled with universal tractor fluid (Mobil 424). The fill/check port is located on the side of the parking brake unit. The drain port is located at the bottom of the parking brake unit. The fluid level should be checked after every 400 hours of operation. Change the fluid after every 1600 hours of operation.

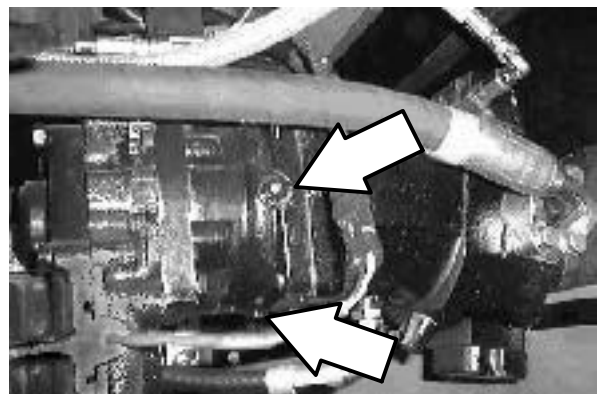

TIRES

The machine tires are pneumatic. The wheels consist of a 3-piece rim, flap, tube and tire.

Check the tire pressure every 50 hours of operation. The proper tire air pressure is:

bias ply tire	759-828 kPa (110-120 psi)
radial tire	930-1000 kPa (135-145 psi)

NOTE: The machine is equipped with 3-piece rims. If the tire pressure falls below 550 kPa (80 psi), the tire and wheel assembly should be brought to an industrial tire service center for repair and/or refilling.

Check the tires for wear and rotate every 200 hours of operation.



WHEEL ALIGNMENT

When the machine has been used for some time, air can get trapped in the hydraulic steering system. This can keep the wheels from tracking properly. The front axle is equipped with a hydraulic valve for aligning the wheels. This should be done after every 50 hours of operation or when the machine is not tracking properly.

To align the wheels, start the machine and turn the steering wheel fully to the left. Move the machine slightly forward and backward to get the full left hand turn. Apply the parking brake. Find the red valve handle and place it on the steering valve located on the front axle. Open the valve by turning the handle 90° in the counter-clockwise direction. Release the parking brake and turn the steering wheel fully to the right. Move the machine slightly forward and backward to get the full right hand turn. Apply the parking brake. Close the valve by turning the handle 90° in the clockwise direction. Remove the red valve handle.

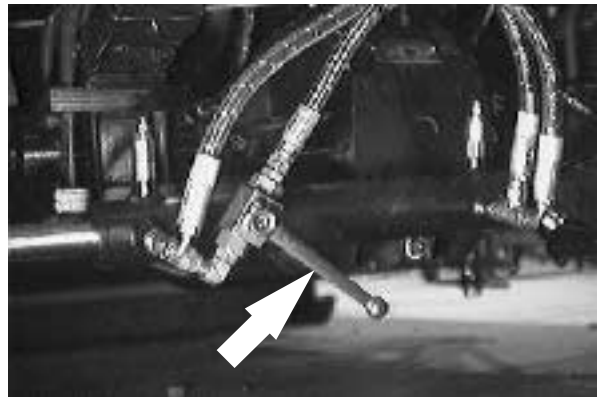

WHEEL NUTS

Check the wheel nut torque on the four wheels every 100 hours of operation. The proper torque is 260 - 305 Nm (190 - 225 ft lb).

**PUSHING, TOWING, AND TRANSPORTING
THE MACHINE**

PUSHING OR TOWING THE MACHINE

If the machine becomes disabled, it can be pushed from the rear or pulled from the front.

The propelling pump has bypass valves to prevent damage to the hydraulic system when the machine is being pushed or towed. **The ignition switch must be turned to the on position to release the parking brake before pushing or towing.** DO NOT exceed 1.6 kmh (1 mph) or 30 meters (100 feet) in distance when moving the machine. The bypass feature is to be used in case of machine breakdown. DO NOT move the machine for any great distance or damage will occur to the propel pump even though the bypass valves are engaged.

ATTENTION! Do not push or tow machine for a long distance and without using the bypass valve, or the machine hydraulic system may be damaged.

Loosen the nuts on the by-pass valves with a 13 mm wrench. Turn in the set screws with a 4 mm allen wrench *until they are below the surface of the nut*. Tighten the nuts.

When finished pushing or towing, loosen the nuts on the bypass valves with a 13 mm wrench. Turn out the set screws with a 4 mm allen wrench until they top out. Tighten the nuts.

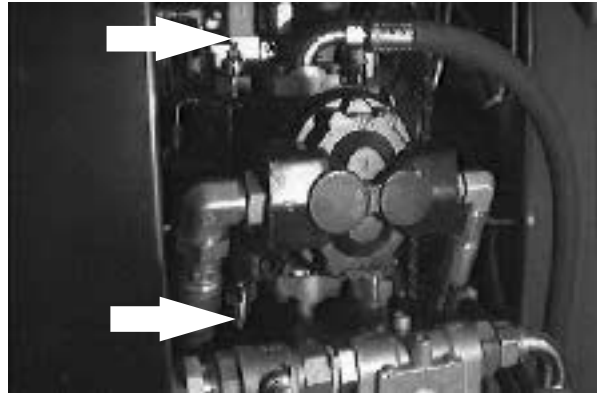

TRANSPORTING THE MACHINE

1. Position the front of the machine at the loading edge of the truck or trailer.

FOR SAFETY: Use truck or trailer that will support the weight of the machine.

NOTE: Empty the hopper and water tank before transporting the machine.

2. If the loading surface is not horizontal or is higher than 380 mm (15 in) from the ground, use a winch to load machine.

If the loading surface is horizontal AND is 380 mm (15 in) or less from the ground, the machine may be driven onto the truck or trailer.

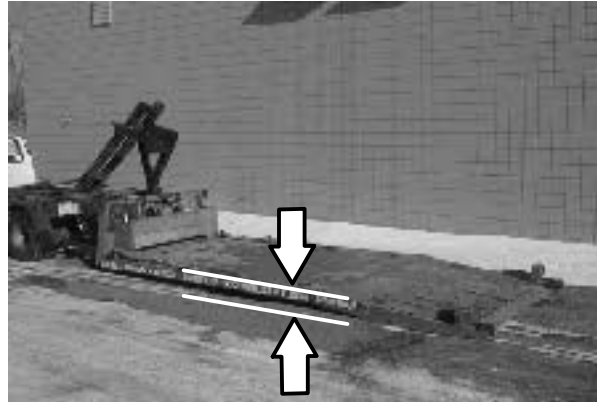

3. To winch the machine onto the truck or trailer, attach the winching chains into the front channel of the machine frame.



4. Open the bypass valves before winching the machine onto the truck or trailer. See *PUSHING OR TOWING THE MACHINE* section of this manual. Make sure the machine is centered.

FOR SAFETY: When loading machine onto truck or trailer, use winch. Do not drive the machine onto the truck or trailer unless the loading surface is horizontal AND is 380 mm (15 in) or less from the ground.

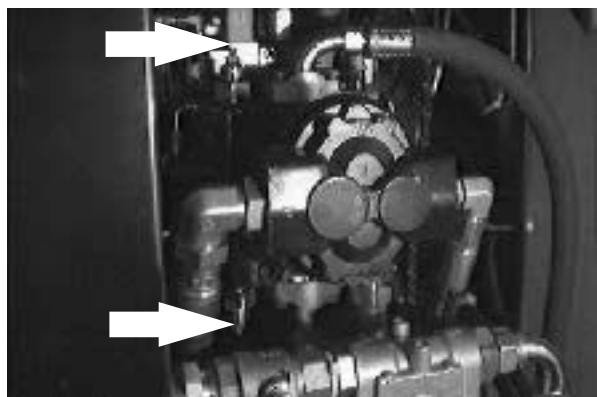

5. Position the machine onto the truck or trailer as far as possible. If the machine starts to veer off the centerline of the truck or trailer, stop and turn the steering wheel to center the machine.

- Set the parking brake and block the machine tires. Tie down the machine to the truck or trailer before transporting.

The front tie-down locations are on the inside channels of the main frame.

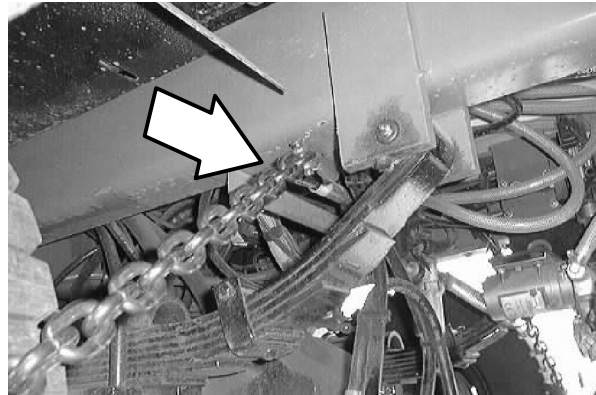

The rear tie-down locations are through the rear channels of the main frame.

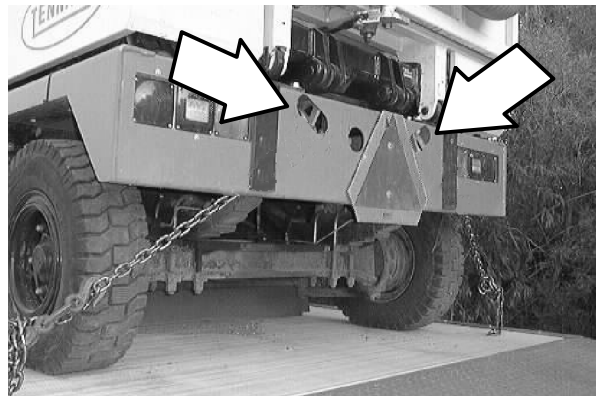

- If the loading surface is not horizontal or is higher than 380 mm (15 in) from the ground, use a winch to unload machine.

If the loading surface is horizontal AND is 380 mm (15 in) or less from the ground, the machine may be driven off the truck or trailer.

FOR SAFETY: When unloading machine off truck or trailer, use winch. Do not drive the machine off the truck or trailer unless the loading surface is horizontal AND 380 mm (15 in) or less from the ground.

MACHINE JACKING

You can jack up the machine for service at the designated locations. Use a Hoist or jack that will support the weight of the machine; a 4-ton jack for empty hopper, and a 6-ton jack with full hopper. It is best to empty the hopper and water tank before jacking the machine.

Always stop the machine on a flat, level surface and block the tires before jacking up the machine.

The front jacking locations are the front axle.

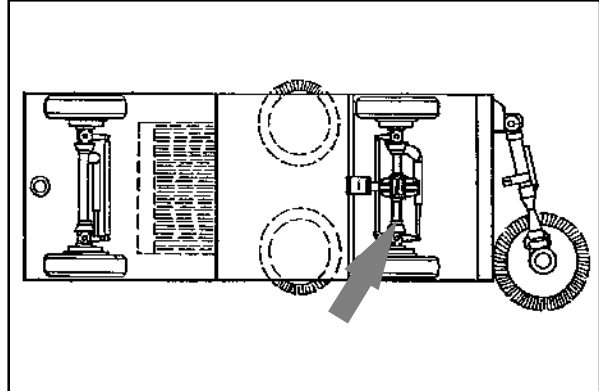

351930

The rear jacking locations are the rear axle.

FOR SAFETY: When servicing machine, block machine tires before jacking machine up.

FOR SAFETY: When servicing machine, jack machine up at designated locations only. Block machine up with jack stands.

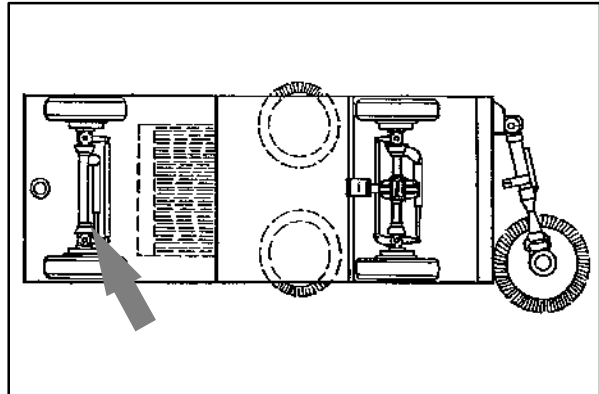

351930

STORING MACHINE

Before storing the machine for an extended period of time, the machine needs to be prepped to lessen the chance of rust, sludge, and other undesirable deposits from forming. Contact TENNANT service personnel.

FREEZE PROTECTION FOR WET DUST CONTROL SYSTEM

1. Open the water valve knobs on the dash panel to drain the lines.
2. Drain the water tank with the drain valve located under the tank.
3. Drain the water lines and pump by opening the drain valve at the water pump under the cab.
4. Remove the water filter cap, located next to the water pump, and empty it.
5. Leave the valves open if the machine is to be stored, or not used for an extended period.

SPECIFICATIONS

GENERAL MACHINE DIMENSIONS/CAPACITIES

Item	Dimension/capacity
Length	4445 mm (175 in)
Length with vario brush option	5230 mm (206 in)
Width	1780mm (70 in)
Height with hazard light	2540 mm (100 in)
Track	1510 mm (59.5 in)
Wheelbase	2920 mm (115 in)
Main brush diameter	610 mm (24 in)
Main brush length	1295 mm (51 in)
Side brush diameter	810 mm (32 in)
Vario Sweeping Brush™ diameter	965 mm (38 in)
Sweeping path width, main brush only	1300 mm (51 in)
Sweeping path width, main brush and right side brush	1750 mm (69 in)
Sweeping path width, main brush and two side brushes	2210 mm (87 in)
Sweeping path width, main brush, two side brushes, and front Vario Sweeping Brush™	3200 mm (126 in)
Main brush pattern width	100 to 125 mm (4 to 5 in)
Hopper weight capacity, Low dump model	3175 kg (7000 lb)
Hopper weight capacity, High dump model	1850 kg (4000 lb)
Hopper volume capacity	2600 L (3.4 yd ³)
Dust filter area	20 m ² (211 sq ft)
Wet dust control water tank (option)	350L (92 gal)
GVWR	9072 kg (20,000 lb)
Axle rating (front and rear)	5000 kg (11,000 lb)
Ceiling height minimum dumping clearance, low dump model	3045 mm (120 in)
Ceiling height minimum dumping clearance, high dump model	5060 mm (199 in)
Hopper dump height (low dump)	1015 mm (48.0 in)
Hopper dump height (high dump)	2895 mm (114 in)

GENERAL MACHINE PERFORMANCE

Item	Measure
Maximum forward speed	40.2 kmh (25 mph)
Maximum reverse speed	19.3 kmh (12 mph)
Minimum steering diameter	7.92 m (26 ft)
Minimum turning radius	3.96 m (13 ft)
Maximum rated climb and descent angle	12° Empty hopper, 8° Full hopper

POWER TYPE

Engine	Type	Ignition	Cycle	Aspiration	Cylinders	Bore	Stroke
Perkins	Piston	Diesel	4	Natural (Turbo)	4	100 mm (3.937 in)	127 mm (5.00 in)
	Displacement		Net power, governed			Net power, maximum	
	4.23 L (257 cu in) - (standard)		59 kw (79 hp) @ 2200 rpm (standard)			64 kw (86 hp) @ 2400 rpm (standard)	
	4.00 L (243 cu in) - (Turbo)		76.5 kw (103 hp) @ 2200 rpm - (Turbo)			80.5 kw (108 hp) @ 2400 rpm - (Turbo)	
	Fuel		Cooling system			Electrical system	
	Diesel Fuel tank: 98.4 L (26 gal)		Water/ethylene glycol antifreeze			12 V nominal	
			Total: 14.2 L (3.75 gal)			105 A alternator	
			Radiator: 0.95 L (1 qt)			12V Battery - 730 cca	
	Idle speed, no load		Governed speed, under load				
	1000 to 1200 rpm		2500 rpm maximum				
	Engine lubricating oil with filter						
	7.6 L (8 qt) 10W30 SAE-CD/SE rated engine oil						
	Air conditioner						
	Refrigerant R134a - total system capacity, 1.9 kg (4 lb)						
	PAG - Refrigerant oil, 59.148 ml (2 oz.)						

SPECIFICATIONS

STEERING

Type	Power source	Emergency steering
Front and rear wheels, hydraulic cylinder, steering rod, and rotary valve controlled	Hydraulic accessory pump	Manual

HYDRAULIC SYSTEM

System	Capacity	Fluid Type
Hydraulic reservoir	68.2 L (18 gal)	TENNANT part no. 65870 (Mobil no. DTE13M) - above 0° C (32°F)
Hydraulic total	121 L (32 gal)	TENNANT part no. 74217 (Mobil no. DTE11M) - below 0° C (32°F)

BRAKING SYSTEM

Type	Fluid	Operation
Service brakes	Universal tractor fluid (Mobil 424)	Hydraulic activated wet multi-disc on all four wheels
Parking brake	Universal tractor fluid (Mobil 424)	Spring activated wet multi-disc on front axle

TIRES

Location	Type	Size	Ply Rating	Pressure
Front and Rear (4)	Bias Ply Pneumatic	7 x 12 in	12	759-828 kPa (110-120 psi)
Front and Rear (4)	Radial Pneumatic	7 x 12 in	16	930-1000 kPa (135-145 psi)

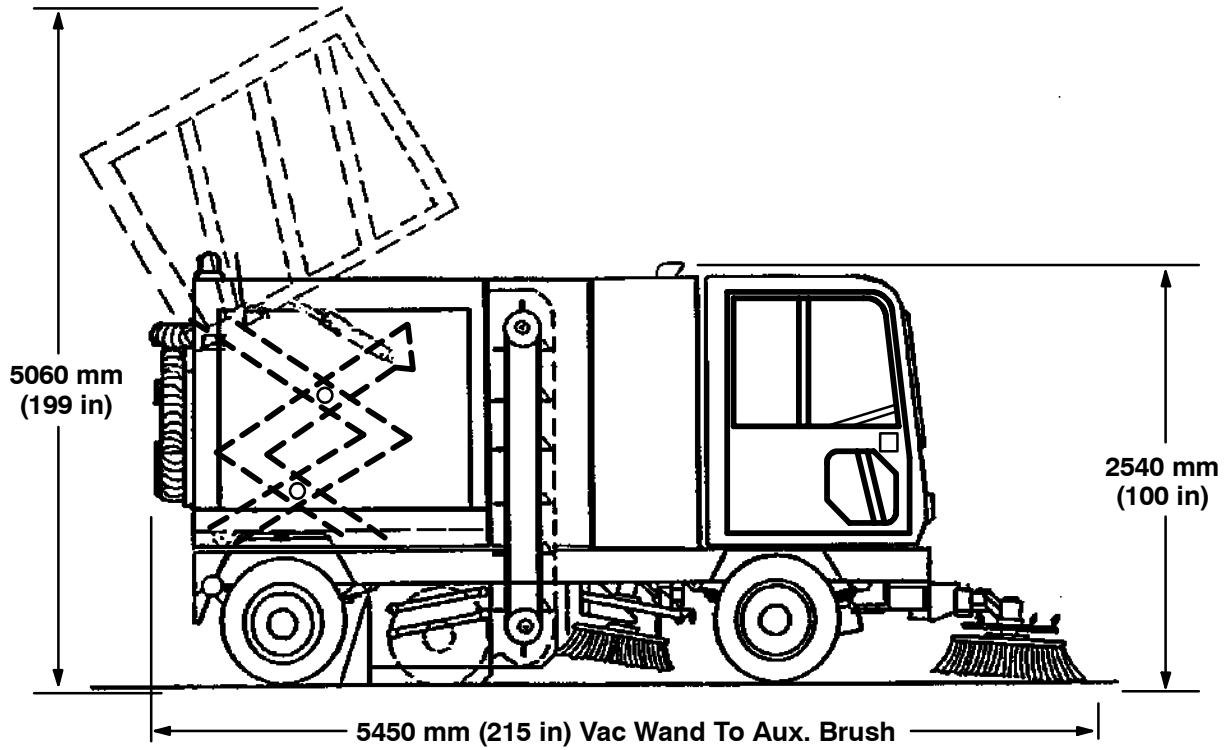

SIDE VIEW

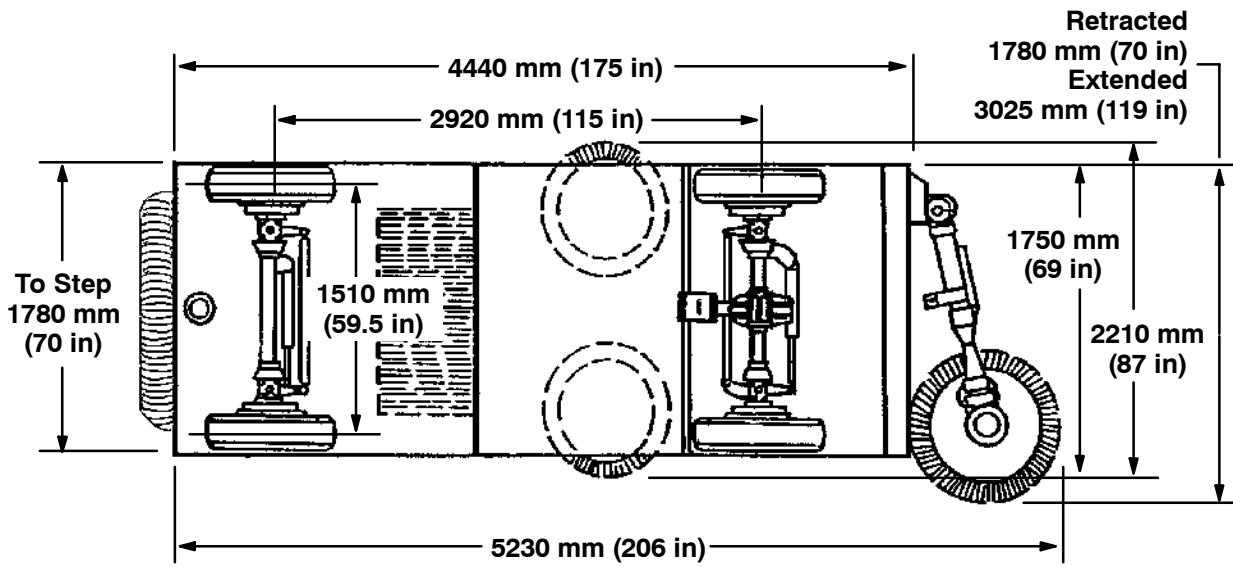

BOTTOM VIEW

MACHINE DIMENSIONS

351930

INDEX**Numbers**

4 way warning lights switch, 43

A

Accessory power socket, 24

Air circulation vents, 29

Air conditioner knob, 28

Air conditioning, Condensor, 90

Air filter, 91

Dust cap, 91

Element, 91

Safety element, 91

Air intake screen, 92

Alarm, Conveyor overload, 56

Axle leaf springs, Lubrication, 83

B

Bar, Hopper support, 47

Battery, 97

Voltmeter, Light, 35

Belt, Seat, 17

Belts, 98

Air conditioner belt, 98

Engine fan belt, 98

Blades, Windshield wiper, 97

Brake, Low brake pressure light, 29

Brake pedal, 20

Brakes, 48, 109

Parking, Adjustment, 109

Parking brake switch, 30

Service, 109

System specifications, 118

Bright headlights light, 25

Brushes, 52–53, 64, 102–107

Checking main brush pattern, 105

Checking side brush pattern, 106

Door latch, 45

Door skirts, 107

Main brush, 102–106

Main brush bristle length, 102

Rear skirt, 107

Replacing main brush, 102–105

Replacing side brush, 106

Side brush, 106

Side brush bristle length, 106

C

Cab, Filters, 96

Capacities, 116

Caps

Engine air filter, 91

Hydraulic filler, 87

Cassette player, 45

Chain, Conveyor, 86

Chains, 98

Conveyor, 101

Static drag, 98

Charging system, voltmeter, 35

Chart, Maintenance, 80–82

Cigarette, lighter, 24

Clogged engine air filter, 26

Condensor, Air conditioning, 90

Controls, 12–14

4 way warning lights switch, 43

Accessory power socket, 24

Air circulation vents, 29

Air conditioner knob, 28

Brake pedal, 20

Bright headlights light, 25

Conveyor reverse switch, 41, 56

Directional lever, 24

Dome and map light switch, 45

Engine oil pressure gauge, 34

Engine shutdown override switch, 30

Engine water temperature gauge, 34

Fan knob, 28

Filter shaker switch, 40

Front night sweeping light switch, 44

Fuel level gauge, 34

Fuse, 33

Hazard light switch, 43

Headlights switch, 19

Heater knob, 28

High pressure washer switch, 44

Hopper door close switch, 39

Hopper door open switch, 39

Hopper lift switch, 38

Hopper lower switch, 38

Hopper overload light, 27

Hopper tilt back switch, 37

Hopper tilt forward switch, 37

Horn, 19

Hourmeter, 35

Ignition switch, 20

Incline light, 29

Latches, 45

Left side brush switch, 40

- Left side brush water valve knob, 31
 - Low brake pressure light, 29
 - Odometer, 35
 - Operation, 17
 - Parking brake light, 25
 - Parking brake switch, 30
 - Parking, headlights, signal lights, and horn switch, 19
 - Propelling pedal, 20
 - Radio and cassette player, 45
 - Rear night sweeping light switch, 44
 - Right side brush switch, 40
 - Right side brush water valve knob, 32
 - Seat belt, 17
 - Side brush spot light(s) switch, 43
 - Signal light, 25
 - Speedometer, 35
 - Steering wheel, 18
 - Steering wheel tilt lever, 18
 - Sweep switch, 42
 - Switch panel, 37
 - Symbols, 10–12
 - Tachometer, 36
 - Throttle lever, 24
 - Vacuum fan switch, 41
 - Vacuum wand door light, 27
 - Vairo sweeping brush lock pin, 21
 - Vario sweeping brush front angle switch, 22
 - Vario sweeping brush joystick, 21
 - Vario sweeping brush left water valve knob, 31
 - Vario sweeping brush on–off switch, 23
 - Vario sweeping brush right water valve knob, 32
 - Vario sweeping brush side angle switch, 23
 - Vario sweeping brush swing switch, 22
 - Voltmeter, 35
 - Water pump switch, 39
 - Water tank low light, 26
 - Windshield wiper and washer switch, 19
- Conveyor, 101
- Bearings, Lubrication, 85
 - Chain, Lubrication, 86
 - Chains, 101
 - Cleaning, 101
 - Overload alarm, 56
 - Paddles, 101
 - Seals, 108
 - Skirts, 101, 107
- Conveyor overload alarm, 56
- Conveyor reverse switch, 41, 56
- Cylinder, Steering , Lubrication, 84
- ## D
- Debris, Conveyor reverse switch, 56
 - Debris hopper, 99–101
 - Differential, Lubrication, 86
 - Dimensions, 116
 - Dimensions, Machine, 119
 - Directional lever, 24
 - Disengaging hopper support bar, 69–71
 - Disengaging hopper support pin, 66–67
 - Dome and map light switch, 45
 - Doors
 - Brush
 - Latch, 45
 - Skirts, 107
 - Cab, Latch, 45
 - Seals, 108
 - Side, Latch, 45
 - Dust Control, Wet
 - Left side water valve, 31
 - Right side water valve, 32
 - Dust control, Wet
 - Filter, 96
 - Operation, 73–75
 - Pump switch, 39
 - Dust filter, 99
 - Changing, 99–101
 - Cleaning, 99
- ## E
- Electrical
 - Battery, 97
 - Fuse, 33
 - Ignition switch, 20
 - Emptying the hopper, 59–61
 - Engaging hopper support bar, 67–69
 - Engaging hopper support pin, 65–67

Engine, 90
 Air conditioner belt, 98
 Air filter, 91
 Air filter dust cap, 91
 Air filter element, 91
 Air filter indicator, 48
 Air filter intake screen, 92
 Clogged air filter light, 26
 Cooling system, 90
 Engine shutdown override switch, 30
 Fan belt, 98
 Fuel filter, 92
 Fuel lines, 93
 Fuel water separator, 92
 Lubrication, 86
 Oil, 86
 Oil capacity, 86
 Oil level, 48
 Oil pressure gauge, Light, 34
 Priming fuel system, 94–95
 Specifications, 117
 Tachometer, 36
 Water temperature gauge, Gauge, 34
Engine oil pressure gauge, 34
Engine shutdown override switch, 30
Engine water temperature gauge, 34

F

Fan knob, 28
Filter
 Clogged engine air, 26
 Hydraulic, 87
Filter shaker switch, 40
Filters
 Cab, 96
 Hydraulic, 87
 Wet dust control, 96

Freeze protection, Wet dust control, 115
Front night sweeping light switch, 44
Fuel, Level gauge, 34
Fuel filter, 92
Fuel level, 48
Fuel level gauge, 34
Fuel lines, 93
Fuel system
 Fuel lines, 93
 Priming, 94–95
Fuel water separator, 92
Fuse, 33

G

Gauges
 Engine oil pressure, 34
 Engine water temperature, 34
 Fuel level, 34
 Hourmeter, 35
 Odometer, 35
 Speedometer, 35
 Tachometer, 36
 Voltmeter, 35
Glow plugs light, 25
GVWR, 8, 52, 116

H

Hazard light switch, 43
Heater knob, 28
High pressure washer switch, 44
Hopper, 99–101
 Changing dust filter, 99–101
 Disengaging hopper support bar, 69–71
 Disengaging hopper support pin, 66–67
 Door close switch, 39
 Door open switch, 39
 Dust filter, 99
 Engaging hopper support bar, 67–69
 Engaging hopper support pin, 65–67
 Filter cleaning, 99
 Filter shaker switch, 40
 Incline light, 29

Lift switch, 38
 Lower switch, 38
 Overload light, 27
 Seals, 108
 Support bar, 47
 Support pin, 46
 Thermo-Sentry, 100
 Tilt back switch, 37
 Tilt forward switch, 37
 Hopper door close switch, 39
 Hopper door open switch, 39
 Hopper lift switch, 38
 Hopper lift/tilt (high dump), Lubrication, 83
 Hopper lower switch, 38
 Hopper overload light, 27
 Hopper support bar, 47
 Hopper support pin, 46
 Hopper Tilt, Lubrication, 83
 Hopper tilt back switch, 37
 Hopper tilt forward switch, 37
 Horn, 19
 Hoses, Hydraulic, 89
 Hourmeter, 35
 How the machine works, 48
 Hydraulic fluid, 88
 Hydraulic fluid reservoir, 87
 Hydraulic hoses, 89
 Hydraulics, 87–89
 Cooler, 90
 Filler cap, 87
 Filters, 87
 Fluid, 88
 Fluid filter, 87
 Fluid level, 87
 Hoses, 89
 Purging air from the hydraulic lift system, 89
 Reservoir, 87
 System specifications, 118

I

Ignition switch, 20
 Incline light, 29, 70
 Inclines, Operating on, 70

J

Jack points, 114
 Joystick, 8
 Joystick, Vario sweeping brush, 21

K

Knobs
 Air conditioner, 28
 Fan, 28
 Heater, 28
 Left side brush water valve, 31
 Right side brush water valve, 32
 Vario sweeping brush left water valve, 31
 Vario sweeping brush right water valve, 32

L

Latches, 45
 Cab doors, 45
 Main brush doors, 45
 Side doors, 45
 Left side brush switch, 40
 Levers
 Directional, 24
 Steering wheel tilt, 18
 Throttle, 24
 Lighter, cigarett, 24
 Lights
 4 way warning lights, 43
 Bright headlights light, 25
 Clogged engine air filter, 26
 Dome and map light switch, 45
 Front night sweeping light switch, 44
 Glow plugs, 25
 Hazard light switch, 43

- Headlights, 19
 - Hopper overload, 27
 - Incline, 29
 - Low brake pressure, 29
 - Parking, 19
 - Parking brake light, 25
 - Rear night sweeping light switch, 44
 - Side brush spot light(s) switch, 43
 - Signal, 25
 - Signals, 19
 - Vacuum wand door, 27
 - Water tank low, 26
- Lock pin, Vairo sweeping brush, 21
- Low brake pressure light, 29
- Lubrication, 82
- Axle leaf springs, 83
 - Conveyor bearings, 85
 - Conveyor chain, 86
 - Differential, 86
 - Engine, 86
 - Hopper tilt, 83
 - Hopper lift/tilt (high dump), 83
 - Main brush support rods, 85
 - Side brush pivot, 84
 - Steering cylinder, 84
 - Vario sweeping brush, 85
 - Wheel pivots points, 84
- M**
- Machine components, 9
- Machine dimensions, 119
- Machine jacking, 114
- Machine leaks, 48, 64
- Machine tie down location, 113
- Machine troubleshooting, 78, 79
- Main brush, 52, 102–106
- Bristle length, 102
 - Checking brush pattern, 105
 - Door latch, 45
 - Door skirts, 107
 - Maintenance, 102
 - Replacing, 102–105
 - Support rods, 85
- Maintenance, 80
- Intervals, 80–82
 - Recommended, 8
- Maintenance chart, 80–82
- O**
- Odometer, 35
- Oil pressure gauge, engine, 34
- Operation, 8–60
- Operation on inclines, 70
- Operator Responsibility, 8
- Operator seat, 17
- Seat belt, 17
- Options
- Air conditioner belt, 98
 - Air conditioner knob, 28
 - Front night sweeping light switch, 44
 - High pressure washer switch, 44
 - Hopper incline light, 29
 - Hopper lift switch, 38
 - Hopper lower switch, 38
 - Left side brush switch, 40
 - Left side brush water valve knob, 31
 - Operation, 71–77
 - Radio and cassette player, 45
 - Rear night sweeping light switch, 44
 - Right side brush switch, 40
 - Right side brush water valve knob, 32
 - Vacuum wand, Operation, 75–77
 - Vacuum wand door light, 27
 - Vairo sweeping brush lock pin, 21
 - Vario sweeping brush, 85
 - Operation, 71–73
 - Vario sweeping brush front angle switch, 22
 - Vario sweeping brush joystick, 21
 - Vario sweeping brush left water valve knob, 31
 - Vario sweeping brush on–off switch, 23
 - Vario sweeping brush right water valve knob, 32
 - Vario sweeping brush side angle switch, 23
 - Vario sweeping brush swing switch, 22
 - Water pump switch, 39
 - Water tank low light, 26
 - Wet dust control, Filter, 96
 - Wet dust control system, Operation, 73–75
- P**
- Parking brake, 109
- Light, 25

Parking brake light, 25
 Parking brake switch, 30
 Parking lights, headlights, signal, and horn switch, 19
 Pedal, Propelling, 20
 Pedals, Brake, 20
 Pin, Hopper support pin, 46
 Post-operation checklist, 64
 Pre-operation checklist, 48–51
 Preheat, Glow plugs, 25
 Priming fuel system, 94–95
 Propelling pedal, 20
 Purging air from the hydraulic conveyor lift system, 89
 Pushing machine, 111
 Pushing or towing the machine, 111
 Pushing, towing, and transporting machine, 111

R

Radiator
 Coolant level, 90
 Coolant type, 90
 Exterior, 90
 Flushing system, 90
 Hoses, 90
 Radio, 45
 Radio and cassette player, 45
 Re-phasing the conveyor lift system, 89
 Rear night sweeping light switch, 44
 Reservoir, hydraulic, 87
 Right side brush switch, 40

S

Safety
 4 way warning lights switch, 43
 Disengaging hopper support bar, 69–71
 Disengaging hopper support pin, 66–67
 Engaging hopper support bar, 67–69
 Engaging hopper support pin, 65–67
 Hopper support bar, 47
 Hopper support pin, 46
 Labels, 6
 Precautions, 4
 Vario sweeping brush lock pin, 21

Safety element, 91
 Seals, 107–109
 Conveyor, 108
 Door, 108
 Hopper, 108
 Seat, 17
 Adjustment, 17
 Seat Belt, 17
 Separator, Fuel water, 92
 Service records, 64
 Side brush, 52, 106
 Bristle length, 106
 Checking brush pattern, 106
 Replacing, 106
 Vario, Lubrication, 85
 Side brush pivot, Lubrication, 84
 Side brush spot light(s) switch, 43
 Side brush switch, left, 40
 Side brush switch, right, 40
 Signal light, 25
 Skids, 109
 Skirts, 64, 107
 Brush compartment, 107
 Brush doors, 107
 Conveyor, 107
 Specifications, 116–117
 Braking system, 118
 GVWR, 116
 Hydraulic system, 118
 Machine capacities, 116
 Machine dimensions, 116
 Machine performance, 117
 Power type, 117
 Steering, 118
 Tires, 118
 Speedometer, 35
 Starting the machine, 49–51
 Static drag chain, 98
 Steering, 48
 Specifications, 118
 Steering cylinder, Lubrication, 84
 Steering wheel, 18
 Steering wheel tilt lever, 18
 Stop sweeping, 57
 Stop the machine, 63–65
 Storing machine, 115
 Freeze protection, 115

Sweep switch, 42
Sweeping, 53–56
Sweeping and brush information, 52–53
Switch Panel
 Conveyor reverse switch, 41
 Filter shaker switch, 40
 Hopper door close switch, 39
 Hopper door open switch, 39
 Hopper lift switch, 38
 Hopper lower switch, 38
 Hopper tilt back switch, 37
 Hopper tilt forward switch, 37
 Left side brush switch, 40
 Right side brush switch, 40
 Sweep switch, 42
 Vacuum fan switch, 41
 Water pump switch, 39
Switch panel, 37
Switches
 4 way warning lights, 43
 Conveyor reverse, 41, 56
 Dome and map light, 45
 Engine shutdown override switch, 30
 Filter shaker, 40
 Front night sweeping light, 44
 Hazard light, 43
 Headlights, 19
 High pressure washer, 44
 Hopper door close switch, 39
 Hopper door open switch, 39
 Hopper lift switch, 38
 Hopper lower switch, 38
 Hopper tilt back, 37
 Hopper tilt forward, 37
 Horn, 19
 Ignition, 20
 Left side brush, 40
 Parking and signal lights, 19
 Parking brake, 30
 Rear night sweeping light, 44
 Right side brush, 40
 Side brush spot light(s), 43
 Sweep, 42
 Switch panel, 37
 Vacuum fan, 41
 Vario sweeping brush swing, 22
 Vario sweeping brush front angle, 22
 Vario sweeping brush on–off, 23
 Vario sweeping brush side angle, 23
 Water pump, 39
 Windshield wiper and washer, 19

T

Tachometer, 36
Thermo-sentry, 100
Throttle, Lever, 24
Throttle lever, 24
Tie down location, 113
Tires, 109–111
 Pressure, 110
 Specifications, 118
Towing machine, 111
Transporting machine, 111
Transporting the machine, 112
Travel speed, 117
Troubleshooting, 78, 79
Turning radius, 117

V

Vacuum fan switch, 41
Vacuum wand
 Door light, 27
 Operation, 75–77
Vacuum wand door light, 27
Vario sweeping brush
 Front angle switch, 22
 Joystick, 21
 Left water valve knob, 31
 Lock pin, 21
 Lubrication, 85
 On–off switch, 23
 Operation, 71–73
 Right water valve knob, 32
 Side angle switch, 23
Vario sweeping brush swing, Switch, 22
Vents, Air circulation, 29

W

Washer, High pressure washer switch, 44
Water pump switch, 39
Water separator, Fuel, 92
Water tank low light, 26
Weight limit, 8, 52, 116

Wet dust control filter, Filter, 96
Wet dust control system, Operation, 73–75
Wheel alignment, 110
Wheel nuts, 110
 Torque, 110
Wheel pivots, Lubrication points, 84
Wheels
 Alignment, 110
 Leaf springs, Lubrication, 83
 Nuts, 110
 Pivots points, Lubrication, 84
Windshield washer, 97
Windshield washer and wiper switch, 19
Windshield wiper, Blades, 97
Windshield wipers, Switch, 19

