

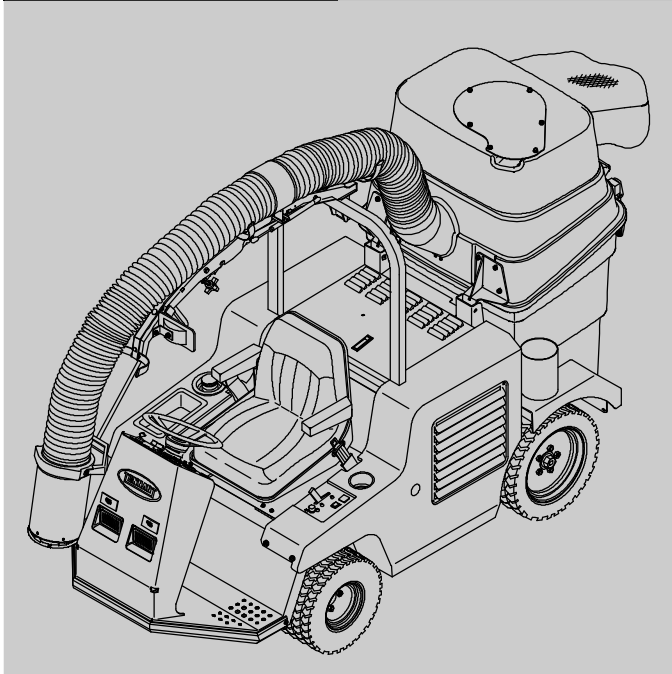

ATLV™ 4300

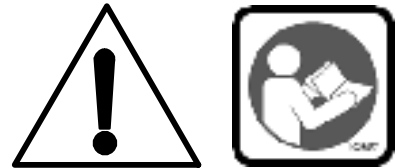

Litter Vacuum Operator Manual



TennantTrue™ Parts and Supplies

North America / International

www.tennantco.com

330510
Rev. 15 (01-2010)





This manual is furnished with each new model. It provides necessary operation and maintenance instructions.

Read this manual completely and understand the machine before operating or servicing it.

This machine will provide excellent service. However, the best results will be obtained at minimum costs if:

- The machine is operated with reasonable care.
- The machine is maintained regularly - per the machine maintenance instructions provided.
- The machine is maintained with manufacturer supplied or equivalent parts.

	PROTECT THE ENVIRONMENT Please dispose of packaging materials, old machine components such as batteries, hazardous fluids including antifreeze and oil, in an environmentally safe way according to local waste disposal regulations.
	Always remember to recycle.

MACHINE DATA	
Please fill out at time of installation for future reference.	
Model No. -	_____
Serial No. -	_____
Machine Options -	_____
Sales Rep. -	_____
Sales Rep. phone no. -	_____
Customer Number -	_____
Installation Date -	_____

Tennant Company
PO Box 1452
Minneapolis, MN 55440
Phone: (800) 553-8033 or (763) 513-2850
www.tennantco.com

 **CALIFORNIA PROPOSITION 65 WARNING:**
Engine exhaust from this product contains chemicals known to the State of California to cause cancer, birth defects, or other reproductive harm.

ATLV is a United States trademarks of Tennant Company.

Specifications and parts are subject to change without notice.

Original Instructions, copyright © 1998-2003, 2005, 2007 - 2010 TENNANT Company, Printed in U.S.A.

CONTENTS

	Page		Page
CONTENTS	1	STOPPING THE MACHINE	44
SAFETY PRECAUTIONS	3	POST-OPERATION CHECKLIST	45
OPERATION	6	EMPTYING THE VACUUM BAG	
OPERATOR RESPONSIBILITY	6	(For machines below serial number	
MACHINE COMPONENTS	7	001070)	46
CONTROL PANEL SYMBOLS	8	EMPTYING THE VACUUM BAG	
CONTROLS AND INSTRUMENTS	9	(For machines with serial number	
OPERATION OF CONTROLS	11	001070 and above)	48
STEERING WHEEL	11	EMPTYING THE HOPPER	49
STEERING WHEEL TILT LEVER	11	OPTIONS	52
IGNITION SWITCH	11	4 POST ROPS AND WEATHER	
TURN SIGNAL LEVER (OPTION)	12	SHIELD (OPTION)	52
VACUUM FAN SWITCH	12	WATER DUST CONTROL (OPTION) .	53
VACUUM HEAD SWITCH (OPTION) ..	12	FILLING THE WATER TANK:	53
FUEL LEVEL GAUGE	13	VACUUM HEAD (OPTION)	54
HOURMETER	13	TO ADJUST VACUUM HEAD	
ENGINE TEMPERATURE LIGHT	13	DOWN STOP:	54
ENGINE OIL PRESSURE LIGHT	14	DUST FILTER BAG (OPTION)	55
CHARGING SYSTEM LIGHT	14	EMPTYING THE DUST	
THERMO SENTRY WARNING		FILTER BAG:	55
LIGHT (OPTION)	14	VACUUM WAND w/ 15 FOOT	
HYDRAULIC FILTER BYPASS LIGHT .	15	EXTENSION (OPTION)	57
PARKING BRAKE LIGHT (OPTION) ..	15	TO OPERATE VACUUM WAND	
GLOW PLUG LIGHT	15	W/15 FOOT EXTENSION:	57
OPERATING LIGHTS SWITCH	16	FENCE LINE ATTACHMENT (OPTION)	59
OPERATING/HAZARD LIGHTS		TO INSTALL FENCE LINE	
SWITCH (OPTION)	16	ATTACHMENT:	59
WORKLIGHT SWITCH (OPTION)	16	PANEL FILTER KIT (OPTION)	61
WATER DUST CONTROL		EMPTYING VACUUM BAG:	61
SWITCH (OPTION)	16	CLEANING THE PANEL FILTER: ..	63
HORN BUTTON	17	MACHINE TROUBLESHOOTING	64
THROTTLE LEVER	17	MAINTENANCE	66
SEAT BELT	17	MAINTENANCE CHART	66
FUSES	18	LUBRICATION	68
CIRCUIT BREAKERS	18	STEERING CYLINDER	68
BRAKE PEDALS	19	WHEEL PIVOTS POINTS	68
PARKING BRAKE PEDALS	19	ENGINE	68
DIRECTIONAL PEDAL	20	HYDRAULICS	69
OPERATOR SEAT	21	HYDRAULIC FLUID RESERVOIR	69
DELUXE SUSPENSION		HYDRAULIC FLUID	70
SEAT (OPTION)	21	HYDRAULIC HOSES	71
VACUUM WAND HANDLE	22	ENGINE	72
VACUUM HOSE SUPPORT ARM	23	COOLING SYSTEM	72
VACUUM HEAD ADJUSTMENT		AIR FILTER INDICATOR	73
KNOB (OPTION)	24	AIR FILTER	73
REAR VIEW MIRRORS	24	FUEL FILTER	74
HOPPER TILT BRACKET	24	FUEL LINES	74
LATCHES	25	4 POST ROPS WIPER BLADES	
HOW THE MACHINE WORKS	26	(OPTION)	75
PRE-OPERATION CHECKLIST	26	BATTERY	75
STARTING THE MACHINE	31	BELTS	76
VACUUMING AND HOSE INFORMATION	35	ENGINE BELT	76
OPERATION ON INCLINES	37	SKIRTS AND SEALS	77
OPERATION OVER CURBS	38	DOOR SEALS	77
VACUUMING	39	VACUUM HEAD SKIRTS (OPTION) ..	77
STOP VACUUMING	42		

CONTENTS

	Page
BRAKES AND TIRES	78
SERVICE BRAKES	78
PARKING BRAKE	78
TIRES	78
FRONT WHEEL	79
REAR WHEEL	79
VACUUM SYSTEM	80
VACUUM BAG	80
DUST PANEL FILTER (OPTION)	80
DUST FILTER BAG (OPTION)	80
VACUUM FAN	80
VACUUM WAND w/ 15 FOOT EXTENSION (OPTION)	81
VACUUM HEAD (OPTION)	81
VACUUM HOSE AND SUPPORT ARM	82
WATER DUST CONTROL (OPTION) .	84
PUSHING, TOWING, AND TRANSPORTING THE MACHINE	87
PUSHING OR TOWING THE MACHINE	87
TRANSPORTING THE MACHINE	88
MACHINE JACKING	90
STORING MACHINE	90
SPECIFICATIONS	92
GENERAL MACHINE DIMENSIONS/CAPACITIES	92
GENERAL MACHINE PERFORMANCE ..	92
STEERING	92
HYDRAULIC SYSTEM	92
POWER TYPE	93
BRAKING SYSTEM	93
TIRES	93
MACHINE DIMENSIONS	94
INDEX	95

SAFETY PRECAUTIONS

The following symbols are used throughout this manual as indicated in their description:



WARNING: To warn of hazards or unsafe practices that could result in severe personal injury or death.

FOR SAFETY: To identify actions that must be followed for safe operation of equipment.

The machine is suited to vacuum disposable debris. Do not use the machine other than described in this Operator Manual.

The following information signals potentially dangerous conditions to the operator or equipment:



WARNING: Machine Can Emit Excessive Noise. Hearing Loss Can Result. Wear Hearing Protection.



WARNING: Moving fan blades. Keep away.



WARNING: Sharp objects in debris canister. Wear gloves.



WARNING: Spinning fan. Stop engine before opening debris canister.



WARNING: Engine Emits Toxic Gases. Severe Respiratory Damage Or Asphyxiation Can Result. Provide Adequate Ventilation. Consult With Your Regulatory Agency For Exposure Limits. Keep Engine Properly Tuned.

FOR SAFETY:

1. **Do not operate machine:**
 - Unless trained and authorized.
 - Unless operation manual is read and understood.
 - In flammable or explosive areas unless designed for use in those areas.
 - In areas with possible falling objects unless equipped with overhead guard.
2. **Before starting machine:**
 - Make sure all safety devices are in place and operate properly.
 - Check brakes and steering for proper operation.
3. **When starting machine:**
 - Keep foot on brake and directional pedal in neutral.
4. **When using machine:**
 - Use brakes to stop machine.
 - Go slowly on inclines and slippery surfaces.
 - Use care when reversing machine.
 - Do not carry riders on machine.
 - Always follow safety and traffic rules.
 - Report machine damage or faulty operation immediately.
5. **Before leaving or servicing machine:**
 - Stop on level surface.
 - Set parking brakes.
 - Turn off machine and remove key.
6. **Before Opening Or Emptying Hopper:**
 - Stop on level surface.
 - Set parking brakes.
 - Turn off vacuum.
 - Turn off machine and remove key.
7. **When servicing machine:**
 - Avoid moving parts. Do not wear loose jackets, shirts, or sleeves.
 - Block machine tires before jacking machine up.
 - Jack machine up at designated locations only. Block machine up with jack stands.
 - Use hoist or jack that will support the weight of the machine.
 - Wear eye and ear protection when using pressurized air or water.
 - Disconnect battery connections before working on machine.
 - Avoid contact with battery acid.
 - Avoid contact with hot engine coolant.
 - Allow engine to cool.
 - Keep flames and sparks away from fuel system service area. Keep area well ventilated.
 - Use cardboard to locate leaking hydraulic fluid under pressure.
 - Use TENNANT supplied or approved replacement parts.

SAFETY PRECAUTIONS

- 8. When loading/unloading machine onto/off truck or trailer:**
 - **Use truck or trailer that will support the weight of the machine.**
 - **Use Winch. Do not drive the machine onto/off the truck or trailer unless the load height is 380 mm (15 in) or less from the ground.**
 - **Set parking brake after machine is loaded.**
 - **Block machine tires.**
 - **Tie machine down to truck or trailer.**

SAFETY PRECAUTIONS

The following safety labels are mounted on the machine in the locations indicated. If these or any label becomes damaged or illegible, install a new label in its place.

SHARP OBJECTS HAZARD LABEL - Located On The Rear Canister.



MOVING FAN HAZARD LABEL- Located On The Rear Canister.



FOR SAFETY LABEL - Located Below The Operator Seat.



FAN WARNING LABEL - Located In The Engine Compartment.



EMISSIONS LABEL - Located Below The Operator's Seat.



NOISE WARNING LABEL - Located Below The Operator's Seat.

OPERATOR RESPONSIBILITY

- The operator's responsibility is to take care of the daily maintenance and checkups of the machine to keep it in good working condition. The operator must inform the service mechanic or supervisor when the required maintenance intervals occur as stated in the *MAINTENANCE* section of this manual.
- Read this manual carefully before operating this machine. View the operation video supplied with the machine.

FOR SAFETY: Do Not Operate Machine, Unless Operation Manual Is Read And Understood.

- Check the machine for shipping damage. Check to make sure machine is complete per shipping instructions.
- Keep your machine regularly maintained by following the maintenance information in this manual. We recommend taking advantage of a regularly scheduled service contract from your TENNANT representative.
- Order parts and supplies directly from your authorized TENNANT representative. Use the parts manual provided when ordering parts.
- The model ATLV™ 4300 has a GVWR of 1180 kg (2600 lbs.) Operate only on surfaces capable of supporting this weight.
- After the first 50 hours of operation, follow the recommended procedures stated in the *MAINTENANCE CHART*.

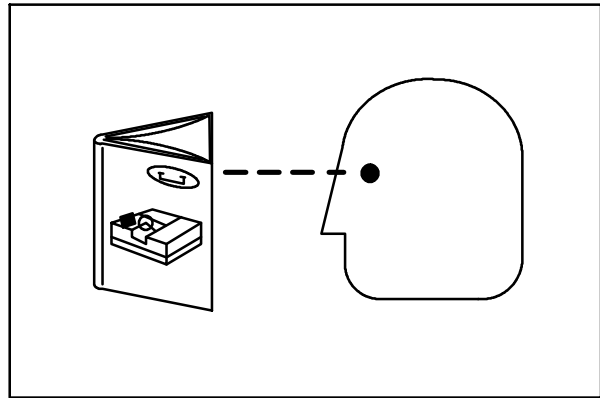

07324

MACHINE COMPONENTS

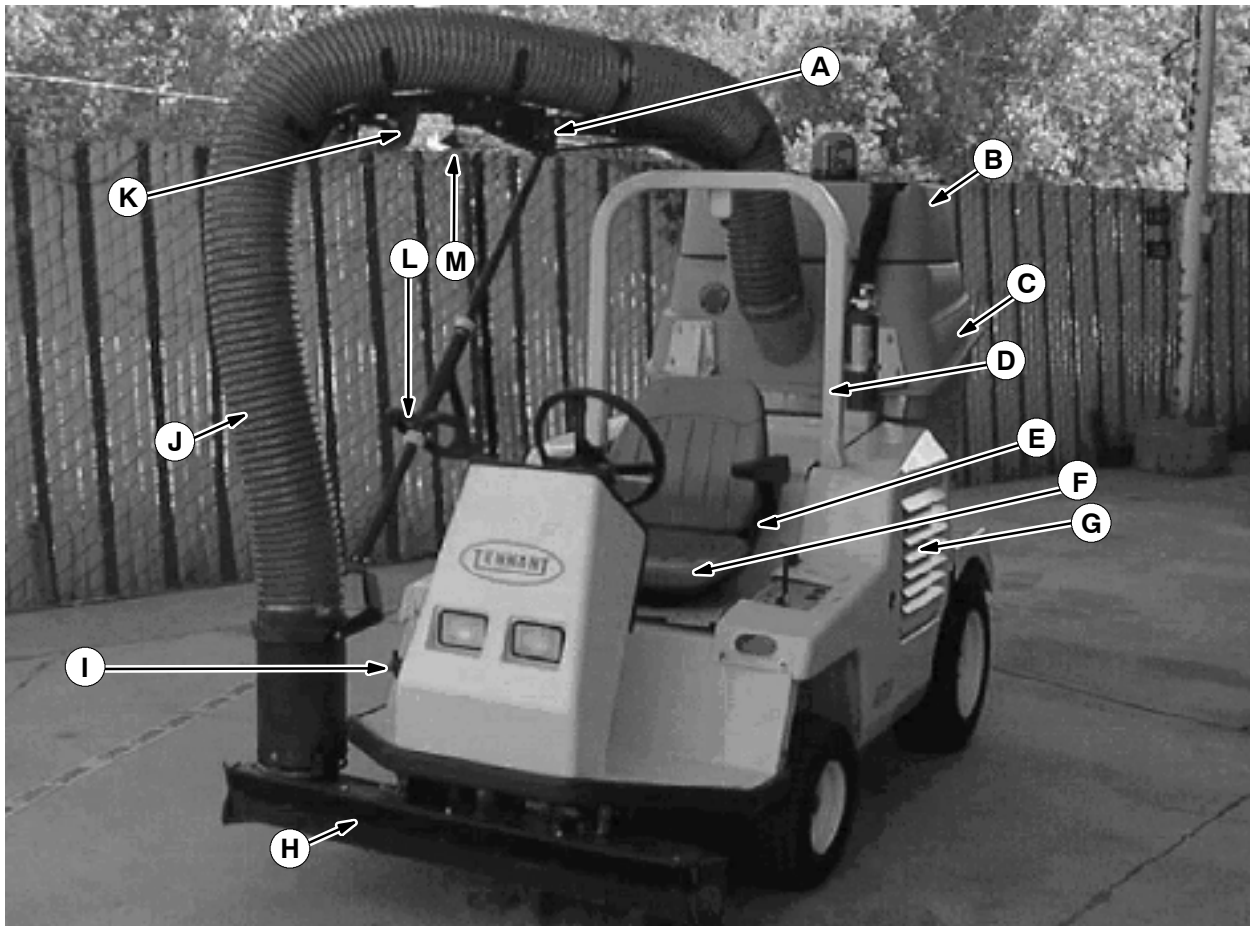



























- A. Vacuum Hose Support Arm
- B. Vacuum Fan
- C. Hopper
- D. Roll Over Protection System
- E. Seat Belt
- F. Operator Seat
- G. Engine
- H. Vacuum Head (Option)
- I. Vacuum Adjustment Knob (Option)
- J. Vacuum Hose
- K. Rear View Mirrors
- L. Vacuum Wand Handle
- M. Vacuum Hose Support Arm Adjustment Knob

OPERATION

CONTROL PANEL SYMBOLS

These symbols identify controls and displays on the machine:

	On		Off
	Start		Fast Vacuum Fan / Engine Speed
	Vacuum Fan		Medium Vacuum Fan / Engine Speed
	Engine Oil Pressure		Idle Engine Speed
	Engine Water Temperature		Circuit breaker #1
	Voltmeter		Circuit breaker #2
	Parking Brake		Circuit breaker #3
	Operating Lights		Circuit breaker #4
	Glow Plug (Preheat)		Circuit breaker #5
	Hazard Light (Option)		Circuit breaker #6
	Signal Light (Option)		Circuit breaker 7
	Vacuum Head Control (Option)		Circuit breaker 8
	Vacuum Hose Height Adjustment		Horn
	Water Dust Control (Option)		

CONTROLS AND INSTRUMENTS

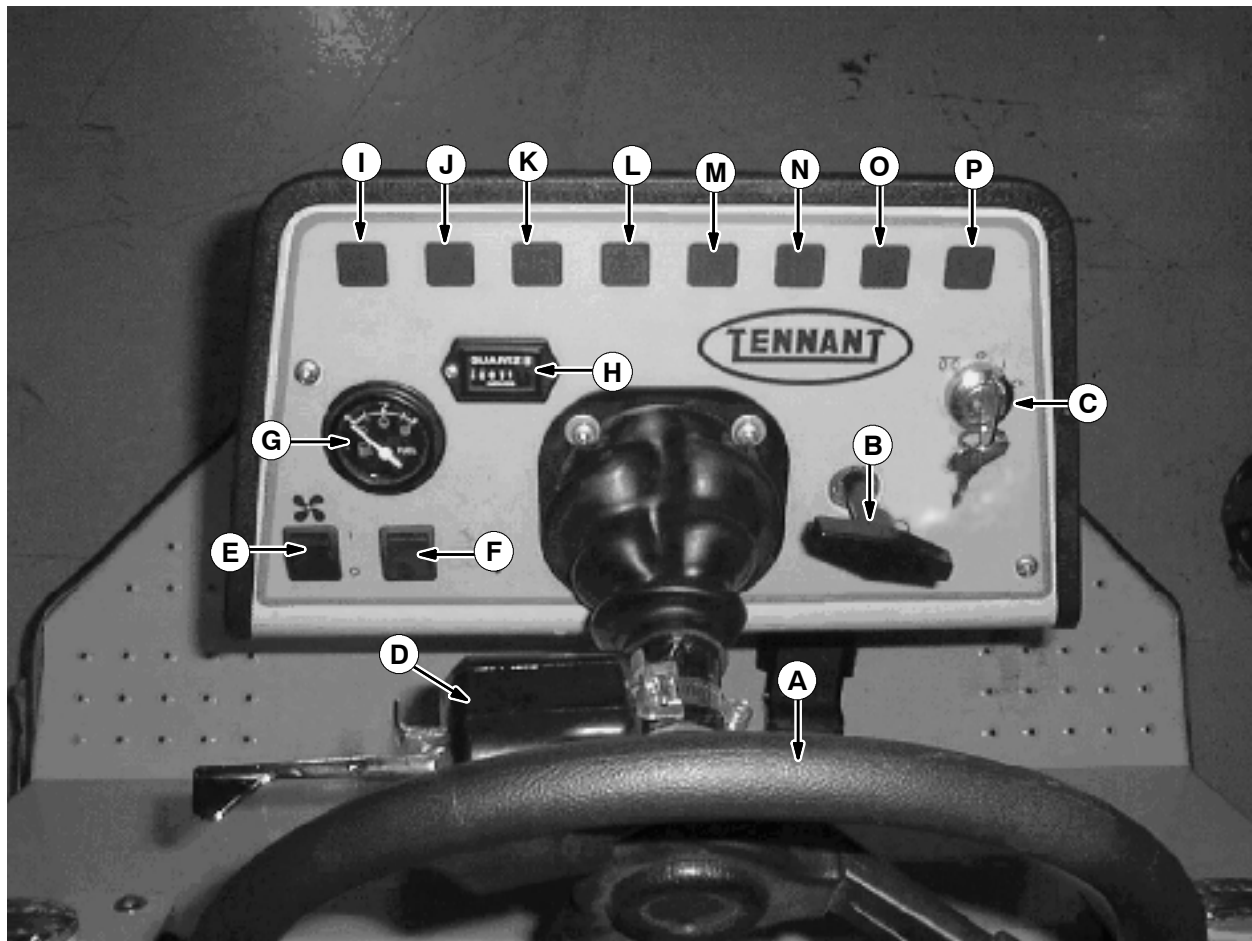

- A. Steering Wheel
- B. Steering Wheel Tilt Lever
- C. Ignition Switch
- D. Turn Signal Lever (Option)
- E. Vacuum Fan Switch
- F. Vacuum Head Switch (Option)
- G. Fuel Level Gauge
- H. Hourmeter
- I. Engine Temperature Light
- J. Engine Oil Pressure Light
- K. Charging System Light
- L. Thermo Sentry™ Warning Light (Option)
- M. Vacant (No Reading)
- N. Hydraulic Filter Bypass Light
- O. Parking Brake Light (Option)
- P. Glow Plug Light

OPERATION

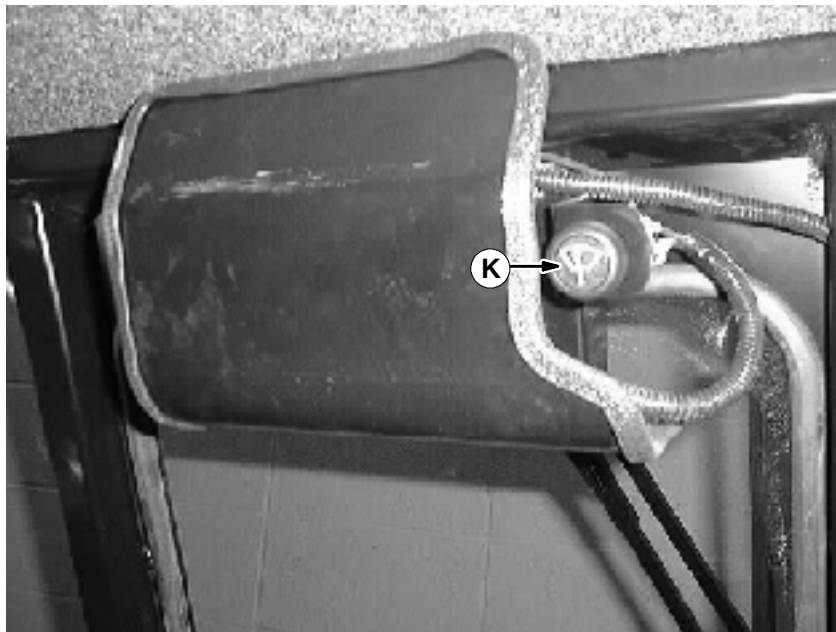
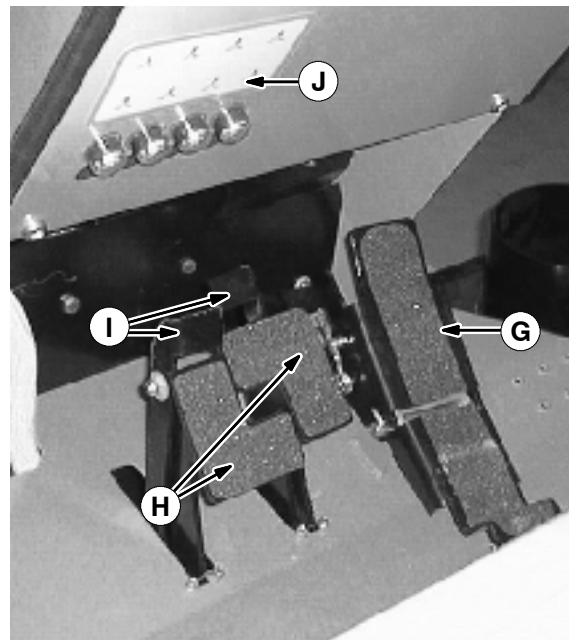
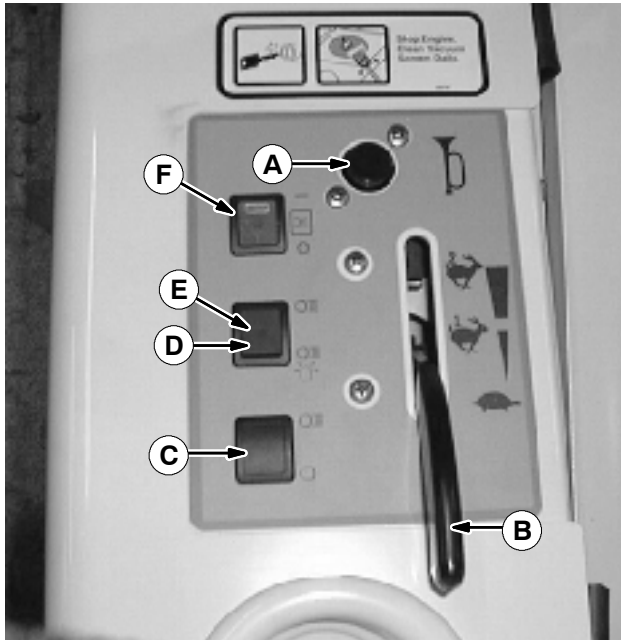

- A. Horn Button
- B. Throttle Lever
- C. Work Lights Switch (Option)
- D. Operating/Hazard Lights Switch (Option)
- E. Operating Lights Switch
- F. Water Dust Control Switch (Option)
- G. Directional Pedal
- H. Brake Pedals
- I. Parking Brake Pedals
- J. Circuit Breaker Panel
- K. Windshield Wiper Knob (Option)

OPERATION OF CONTROLS

STEERING WHEEL

The *steering wheel* controls the machine's direction. The machine is very responsive to the steering wheel movements.

Left: Turn the steering wheel to the left.

Right: Turn the steering wheel to the right.

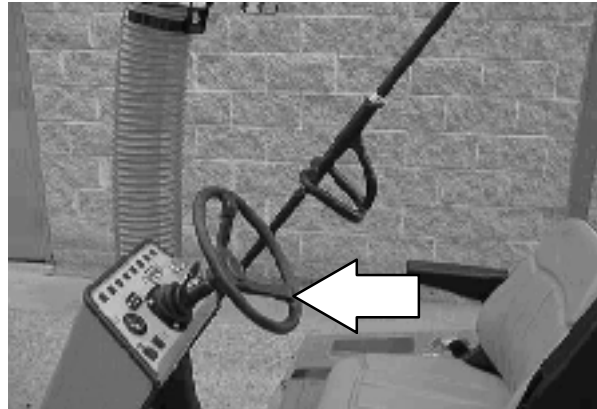
**STEERING WHEEL TILT LEVER**

The *steering wheel tilt lever* is used to adjust the angle of the steering wheel. To tilt the steering wheel, pull the lever straight out. Position the steering wheel at the desired angle, then release the lever.

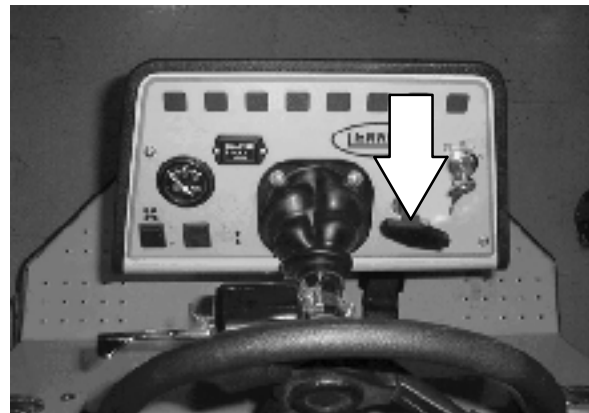
**IGNITION SWITCH**

The *ignition switch* starts and stops the engine with a key.

FOR SAFETY: When starting machine, keep foot on brake and directional pedal in neutral.

Preheat: Turn the key counter-clockwise. The glow plug light will come on. When the glow plug light goes out, usually in 5 to 30 seconds depending on the weather conditions, the engine is ready to start.

Start: Turn the key all the way clockwise. Release the key as soon as the engine starts.

Stop: Turn the key counter-clockwise.

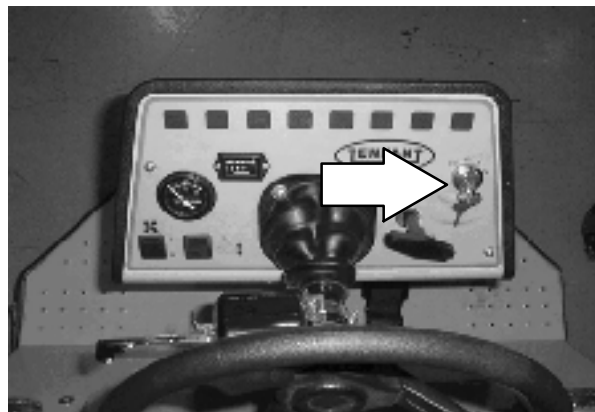

OPERATION

TURN SIGNAL LEVER (OPTION)

The *turn signal lever* is used to activate the turn signal lights when turning.

Right Signal On: Push the lever up.

Left Signal On: Push the lever all the way down.

Signal Off: Return the lever to the middle position.

Four Way Flashers: Pull out the knob.

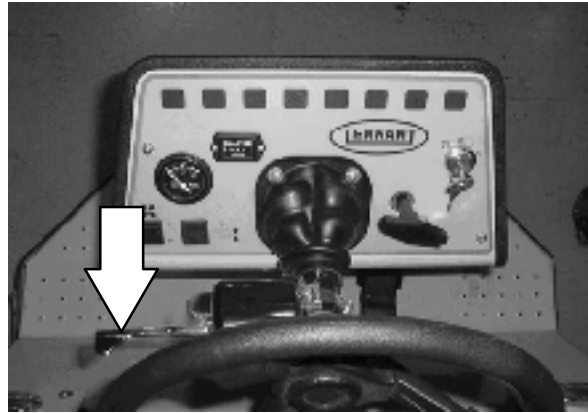

VACUUM FAN SWITCH

The *vacuum fan switch* controls the machine's vacuum fan.

Vacuum On: Press the top of the switch.

Vacuum Off: Press the bottom of the switch.

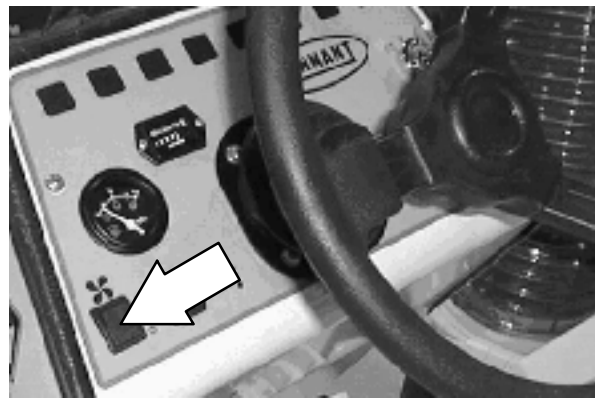

VACUUM HEAD SWITCH (OPTION)

The *vacuum head switch* raises and lowers the vacuum head that mounts under the front end of the machine.

Raise: Press the bottom of the switch.

Lower: Press the top of the switch

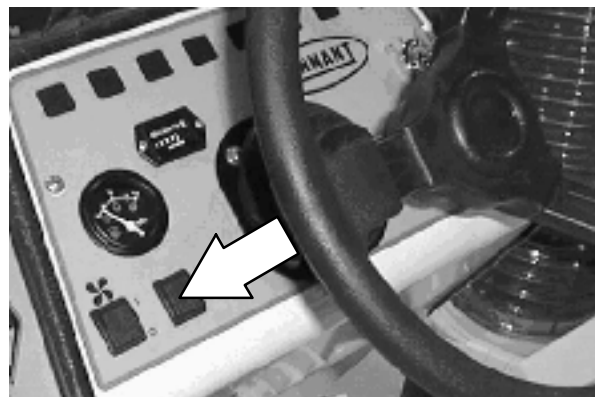

FUEL LEVEL GAUGE

The *fuel level gauge* indicates how much fuel is left in the fuel tank.

Note: Do not let the fuel tank empty completely. Air can enter the fuel system, and it may need bleeding before the next engine start.

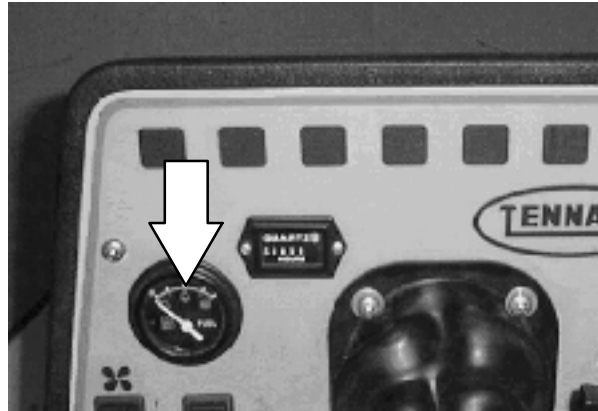

HOURLMETER

The *hourmeter* records the number of hours the machine has been operated. The hourmeter displays the number of hours in tenths of an hour. Use this information to determine machine maintenance intervals.

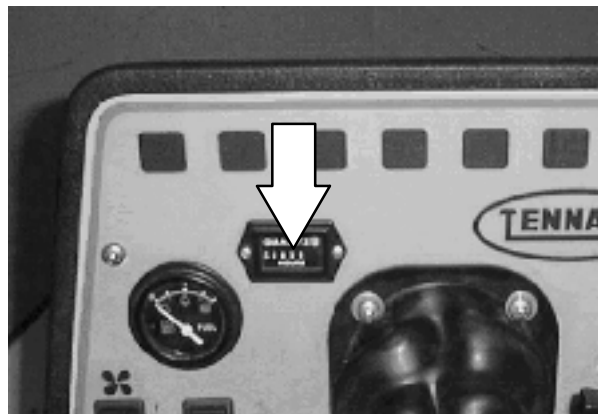

ENGINE TEMPERATURE LIGHT

The *engine temperature light* comes on when the temperature of the engine coolant is more than 113° C (235° F). If the light comes on, stop operating the machine. Locate the problem and have it corrected. See the MAINTENANCE section of this manual.

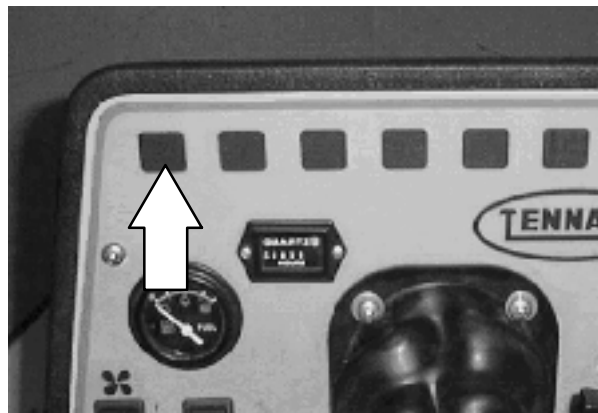

OPERATION

ENGINE OIL PRESSURE LIGHT

The *engine oil pressure light* comes on when the engine oil pressure falls below 40 kPa (5psi). If the light comes on, stop operating the machine. Locate the problem, and have it corrected.

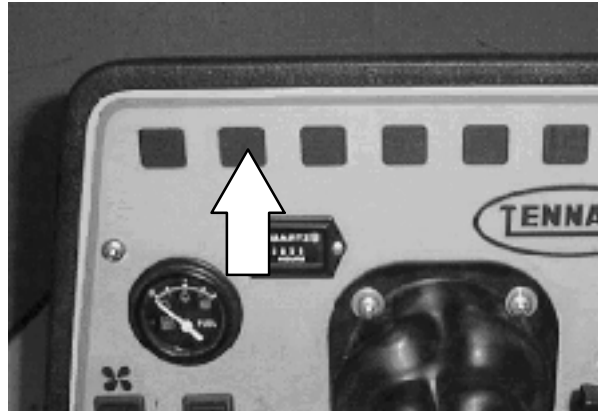

CHARGING SYSTEM LIGHT

The *charging system light* comes on when the alternator is not operating within normal range; 13.5 to 14.5 V. If the light comes on, stop operating the machine. Locate the problem, and have it corrected.

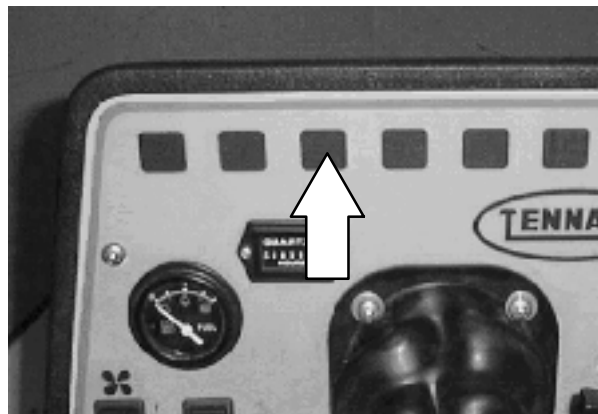

THERMO SENTRY WARNING LIGHT (OPTION)

The *Thermo Sentry warning light* comes on when the Thermo Sentry senses that there is excessive heat in the hopper, possibly from a fire. The Thermo Sentry will also **shut off** the vacuum fan. If this happens, stop the machine and eliminate the source of heat. Allow the sensor to cool, and it will reset automatically.

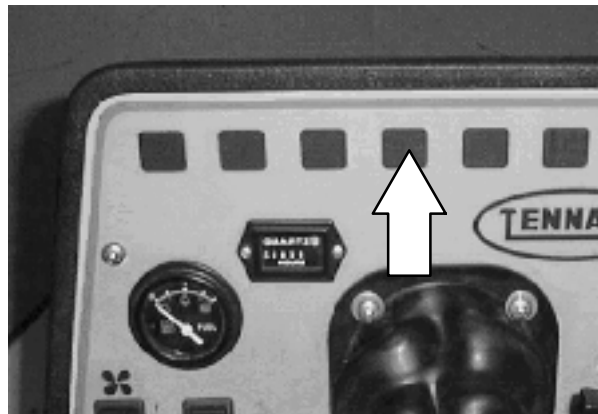

HYDRAULIC FILTER BYPASS LIGHT

The *hydraulic filter bypass light* comes on when the hydraulic filter is clogged. If this light comes on, have the hydraulic filter and hydraulic fluid changed as soon as possible.

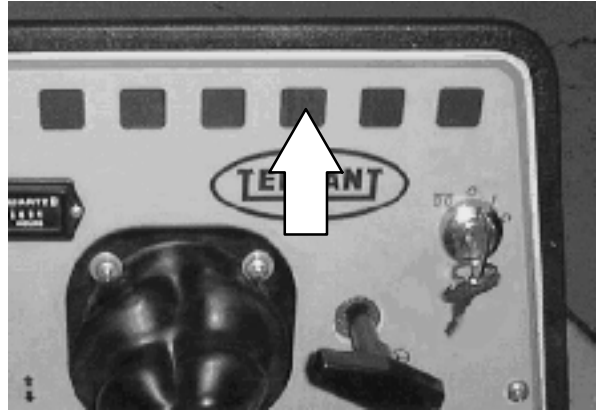
**PARKING BRAKE LIGHT (OPTION)**

The *parking brake light* comes on when the parking brake pedals are engaged. To turn off the light, simply disengage the parking brake pedals before moving.

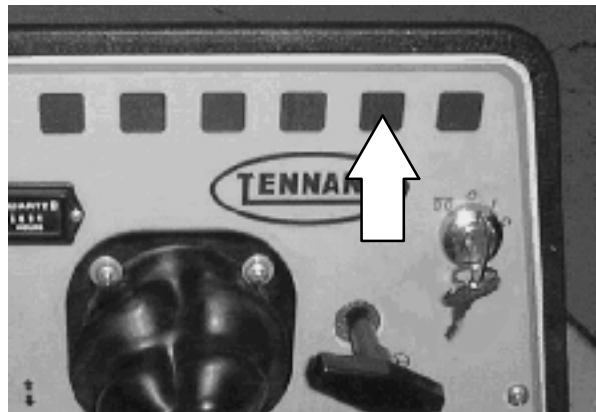
**GLOW PLUG LIGHT**

The *glow plug light* comes on when the ignition switch is turned counterclockwise to the **Glow Plug** position. The light will go out when the engine is ready to start.

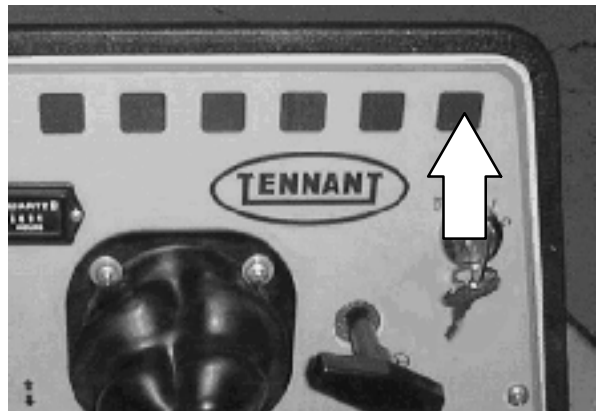

OPERATION

OPERATING LIGHTS SWITCH

The *operating lights switch* powers on and off the headlights and taillights.

On: Press the switch to the forward position.

Off: Press the switch to the middle position.



OPERATING/HAZARD LIGHTS SWITCH (OPTION)

The *operating/hazard lights switch* powers on and off the headlights, taillights and the hazard light option.

Operating lights on: Press the switch to the forward position.

Operating/Hazard lights on: Press the switch to the back position.

Off: Press the switch to the middle position.



WORKLIGHT SWITCH (OPTION)

The *worklight switch* controls the worklights.

Worklights on: Press the switch to the forward position.

Worklights off: Press the switch to the back position.



WATER DUST CONTROL SWITCH (OPTION)

The water dust control switch powers on and off the water dust control located in the debris canister.

On: Press the switch to the forward position. The switch will light up.

Off: Press the switch to the back position. The light in the switch will turn off.



HORN BUTTON

The *horn button* controls the horn.

Sound: Push button

**THROTTLE LEVER**

The *throttle lever* controls the engine speed and vacuum fan power.

Move the throttle lever forward until desired engine speed/vacuum power is reached .

Idle: Pull the lever backward.

Normal Operating Speed / Vac Power: Push the lever to the middle *Speed 1* position.

Max Operating Speed/ Vac Power: Push the lever all the way forward to the *Speed 2* position.

**SEAT BELT**

The *seat belt* holds the operator securely in the operator's seat.

Connect seat belt: Insert the male end of the seat belt into the female end until they click securely into place.

Disconnect seat belt: Press the button on the female end buckle and pull the ends apart.

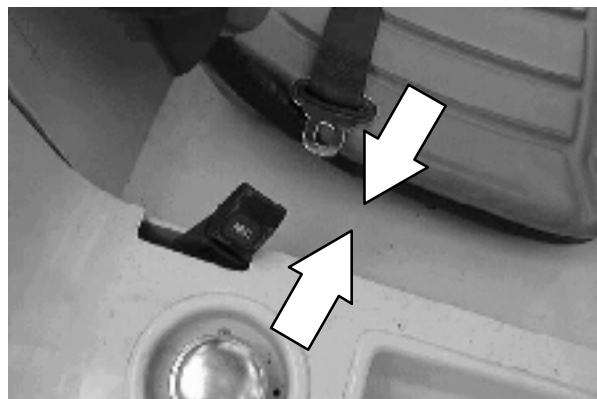

OPERATION

FUSES

The *fuse* is a one-time protection device designed to stop the flow of current in the event of a circuit overload. ***Never substitute higher value fuses than specified.***

The fuse is located behind the circuit breaker panel.

Fuse	Rating	Circuit Protected
FU-1	30 A	Glow plug

CIRCUIT BREAKERS

The *circuit breakers* are resettable electrical circuit protection devices. Their design stops the flow of current in the event of a circuit overload. Once a circuit breaker is tripped, it must be reset manually. Press the reset button after the breaker has cooled down.

If the overload that caused the circuit breaker to trip is still there, the circuit breaker will continue to stop current flow until the problem is corrected.

The circuit breaker panel is located above the foot pedals

The chart lists the circuit breakers and the electrical components they protect.



Breaker	Rating	Circuit Protected
CB-1	15 A	Accessory/ Vac/ Hyd
CB-2	15 A	Horn
CB-3	15 A	Work Lights
CB-4	15 A	Operating Lights
CB-5	15 A	Brake/ Turn signals Back Up alarm
CB-6	15 A	Open Cab Acc.
CB-7	15 A	Options
CB-8	15 A	Options

BRAKE PEDALS

The *brake pedals* slow down and stop the machine. Each pedal operates its own rear brake independently.

Stop Machine: Take your foot off the directional pedal, and let it return to the neutral position. Step on both of the brake pedals.

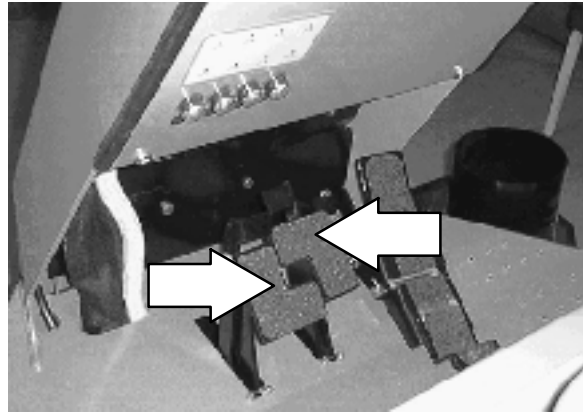

The brake pedals run each brake independently. The operator can use the brakes to remove the machine from a stuck position. If a tire is slipping or unable to make contact with the driving surface, simply press on that tire's brake pedal while slowly pressing on the propelling pedal. This will divert the power to the opposite tire, helping to move the machine from its position.

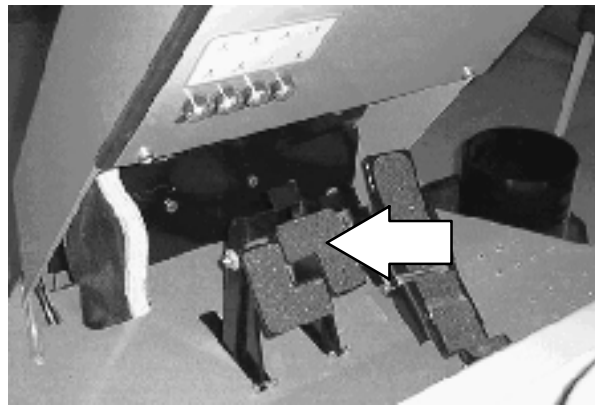

PARKING BRAKE PEDALS

The *parking brake pedals* set and release the brake pedals.

Set parking brakes: While pressing both brake pedals down as far as they will go, set the parking brakes by pressing the parking brake pedals with the toe portion of your foot. The parking brake light (option) will turn on while the parking brake is set. Always set both parking brake pedals when parking the machine.

Release parking brakes: Press on the brake pedals to unlock the parking brake pedals.

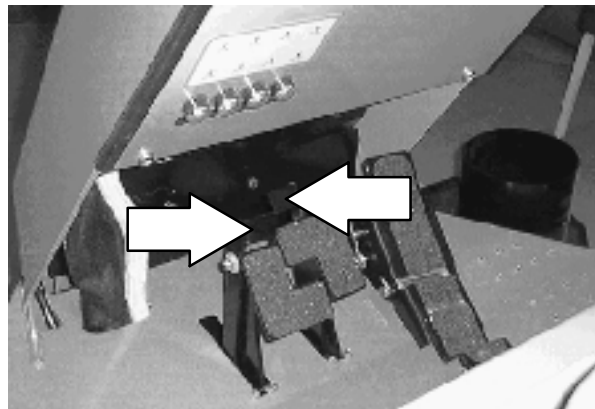

OPERATION

DIRECTIONAL PEDAL

The *directional pedal* controls the direction of travel and the propelling speed of the machine. You can change the speed of the machine with the pressure of your foot on the pedal; the harder you press the pedal, the faster the machine travels.

Forward: Press the top of the directional pedal with the toe of your foot.

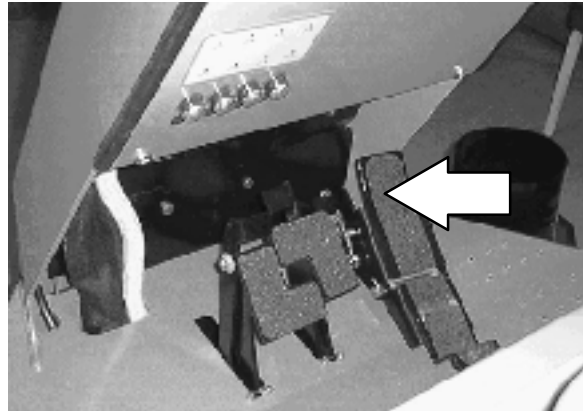

Reverse: Press the bottom of the pedal down with the heel of the foot.

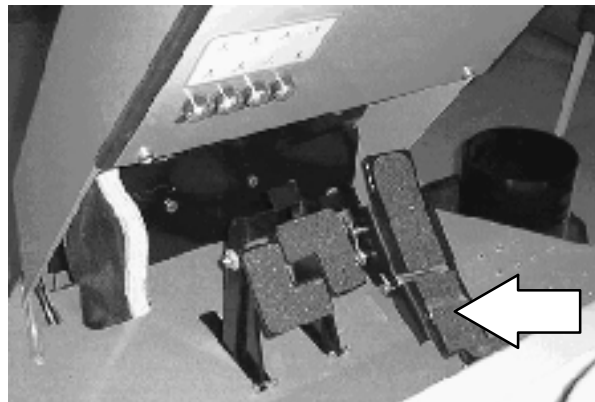

Neutral: Take your foot off the directional pedal and it will return to the **Neutral** position.

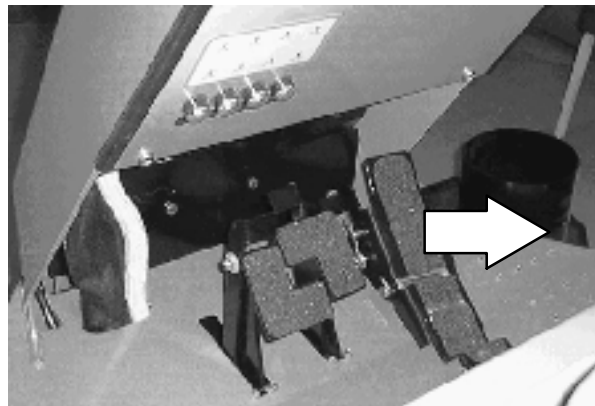

Note: There is a pedal angle adjustment pin behind the propelling pedal. Remove the pin, set the pedal at the desired angle for operation and reinsert the pin.

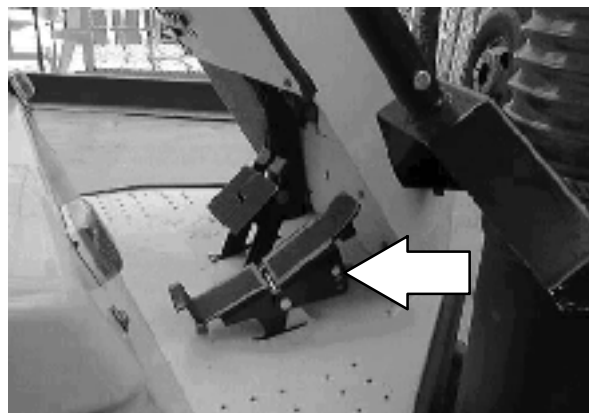

OPERATOR SEAT

The *operator seat* is a fixed back style with a forward-backward adjustment.

Adjust: Push the lever to the left, slide the seat backward or forward to the desired position and release the lever.



DELUXE SUSPENSION SEAT (OPTION)

The *deluxe suspension seat* has three adjustments. The adjustments are for the operator's weight, backrest angle and the front-to-rear seat position.

The *operator's weight adjustment lever* controls the seat weight adjustment. The lever has three positions: lightweight, middleweight and heavyweight.

Adjust: Pull the lever up for the lightweight position, move the lever to the middle position for middleweight, and push the lever down for the heavyweight position.

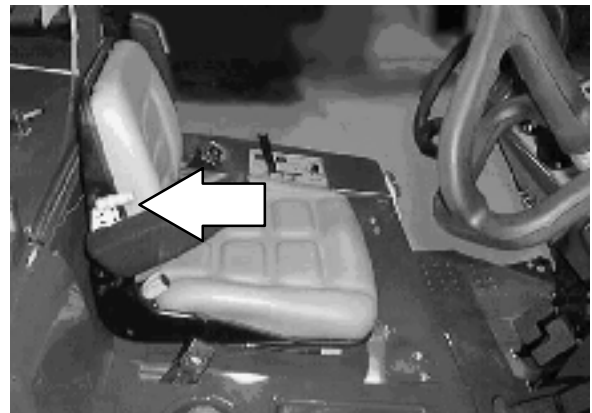

The *backrest angle knob* adjusts the backrest angle.

Adjust: Turn the angle knob clockwise to decrease the angle of the backrest. Turn the knob counterclockwise to increase the angle of the backrest.

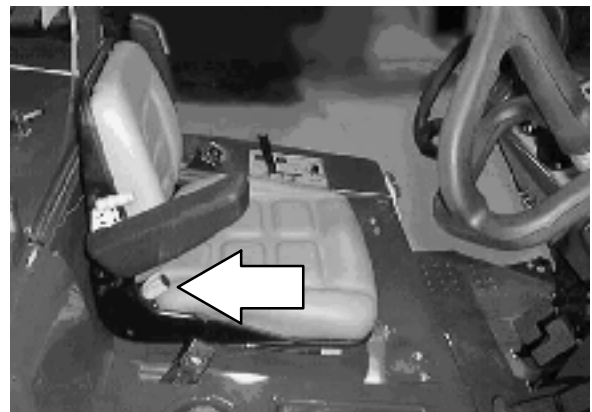

The *front-to-rear position lever* adjusts the seat position.

Adjust: Pull the lever out, slide the seat backward or forward to the desired position and release the lever.

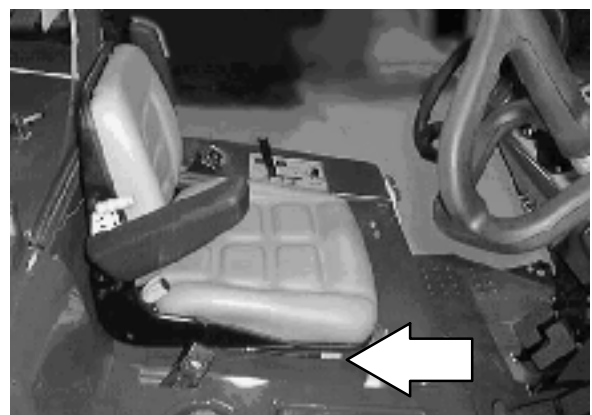

OPERATION

VACUUM WAND HANDLE

The *vacuum wand handle* is used to control the intake end of the vacuum hose. The vacuum wand can be positioned on either side of the machine. The vacuum wand handle is adjustable, and can be positioned at any height on the vacuum wand.

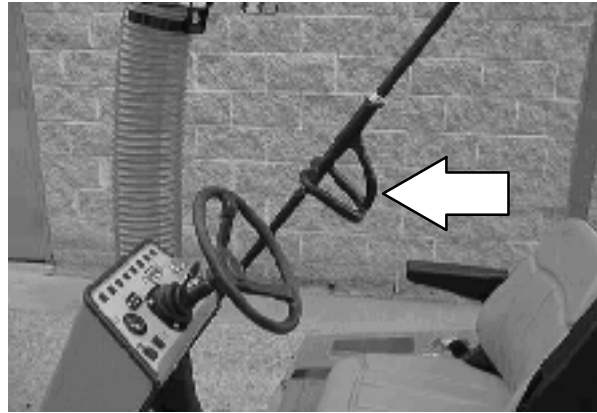

To adjust the vacuum wand handle: Loosen the screws on either end of the wand handle, position the handle to the desired height, and tighten the screws.

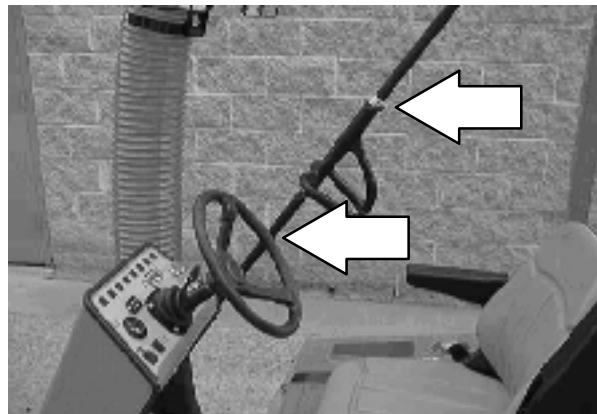

To remove the vacuum hose from the optional vacuum head: Push forward and up on the vacuum wand handle, and lift the vacuum hose off the vacuum head.

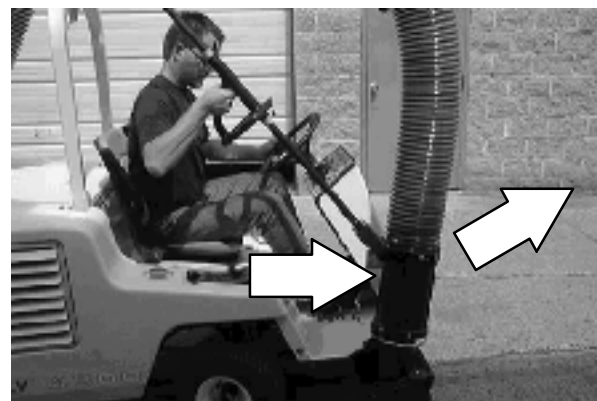

VACUUM HOSE SUPPORT ARM

The *vacuum hose support arm* is a gas cylinder supported arm that holds the vacuum hose at any adjustable height above the ground.

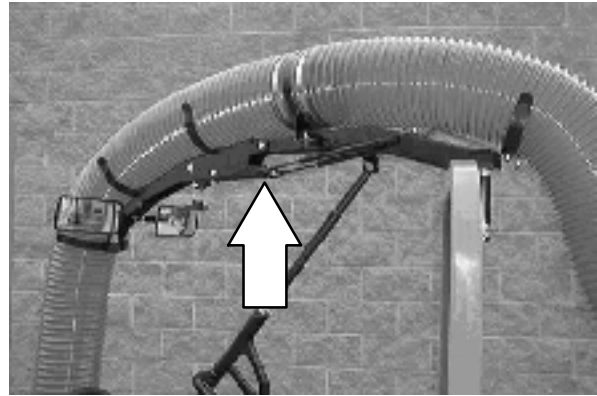

To adjust arm height: Turn the adjustment knob clockwise or counterclockwise to adjust the gas cylinders, and raise or lower hose to preferred height.

Raise vacuum hose: Turn knob counter clockwise.

Lower vacuum hose: Turn knob clockwise.

Note: After turning the adjustment knob, pull the vacuum wand support arm down and let it spring up to determine the effect of the adjustment. Adjust further if necessary.

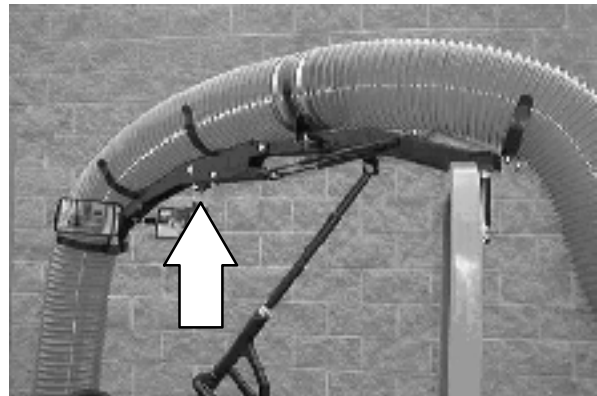

OPERATION

VACUUM HEAD ADJUSTMENT KNOB (OPTION)

The *vacuum head adjustment knob* controls the down stop for the ground clearance height on the lowered vacuum head.

To set the clearance height: Lower the vacuum head as low as it will drop with vacuum head control switch.

Raise vacuum head adjustment: Turn the knob counterclockwise.

Lower vacuum head adjustment: Turn the knob clockwise.

Note: When adjusted properly, the rear skirt of the vacuum head should be rolled out about 13mm (.50 in) in the rear on a flat hard surface.

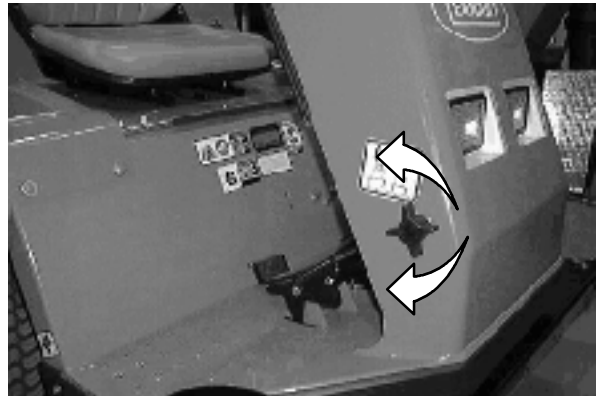

REAR VIEW MIRRORS

The *rear view mirrors* are used by the machine operator to keep an eye on the area behind the machine that is not in the standard field of vision.

To adjust mirrors: Sit in the operator's seat. Move each mirror until it is properly adjusted for the individual operator's rear viewing area.



HOPPER TILT BRACKET

The *hopper tilt bracket* is located under the rear of the hopper. The bracket will hold the hopper in place when it is lowered into the *bag tying position*. The bracket will “snap” and release the hopper when it is pushed down into the *debris removal position*.

FOR SAFETY: When Using Machine, Do Not Move Machine With Hopper Open.

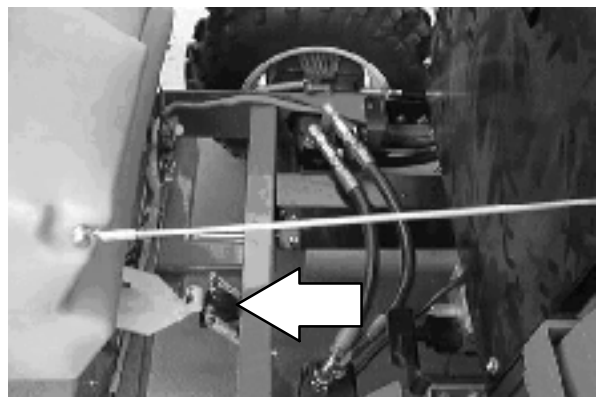

LATCHES

The engine door is secured with a latch.

Open: Press on the raised part of the latch.

Close: Close the door and press on the flat end of the latch.

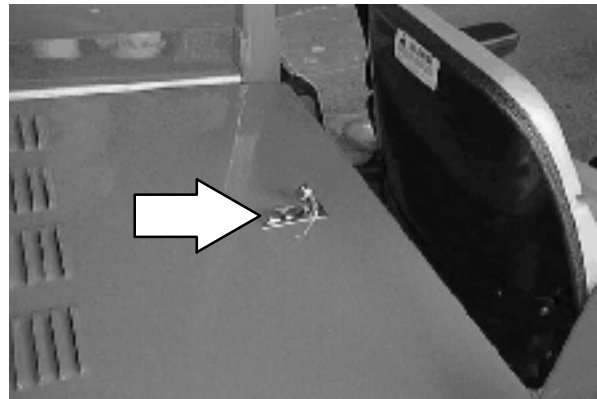

Machines with serial numbers below #001070 have a vacuum bag quick release strap secured with a latch and cotter pin.

Open: Remove cotter pin and lift up on the raised part of the latch.

Close: Press on the raised part of the latch until the strap is secured. Replace the cotter pin.

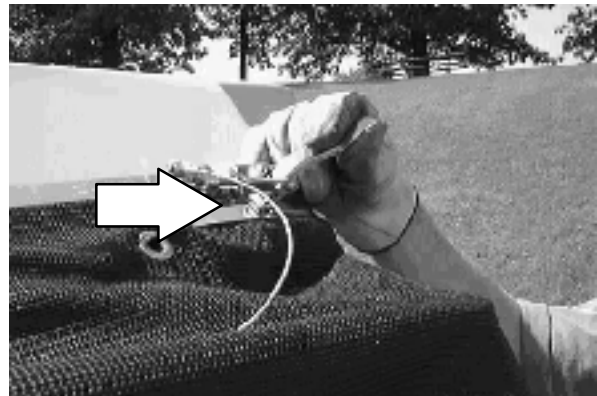

The hopper top is secured with two latches.

Open: Lift up on the bottom tab of the latch, and raise the latch up out of the lower holding bracket.

Close: Check that there is no debris on the outer edge of the hopper. Close the hopper lid securely. Place the top of the latch in the slotted bracket on the hopper bottom. Push down on the latch until it snaps into place.

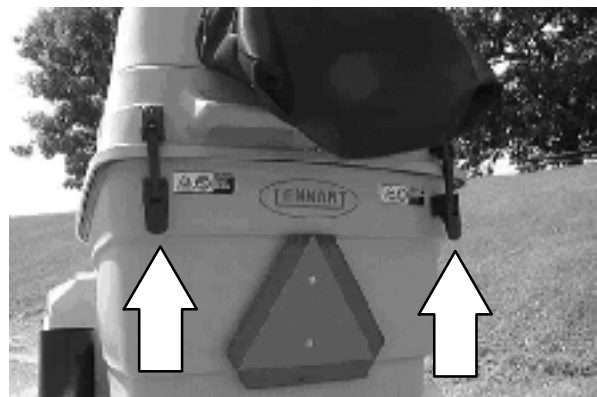

The panel filter option door is secured with two latches.

Open: Pull the rear of the latch away from the filter housing, and then unhooking the front of the latch from the keeper.

Close: Hook the front of the latch onto the keeper and push latch towards the filter housing until it snaps into place.



OPERATION

Machines with serial numbers 003017 and above have a hydraulic cooler that opens for cleaning. It is located behind the Radiator inlet screen. Pull out the pins to remove the screen to access.

Open: Pull up on the latch.

Close: Push the latch into the hole, then push the latch down.



HOW THE MACHINE WORKS

The steering wheel controls the direction of machine travel. The directional pedal controls the forward/reverse direction and the machine speed. The brake pedal slows and stops the machine.

The machine vacuums large debris from various terrain. The vacuum hose is controlled by the operator. The vacuum takes debris in through the hose and transfers the debris into the hopper.

The machine has an optional Vacuum Head, and an optional wand with a 4572 mm (15ft.) extension.

When vacuuming is finished, check the vacuum hose, clean the hopper fan screen and empty the hopper.



PRE-OPERATION CHECKLIST

- Check under the machine for leaks (fuel, oil, coolant).



- Empty the engine air filter dust cap.

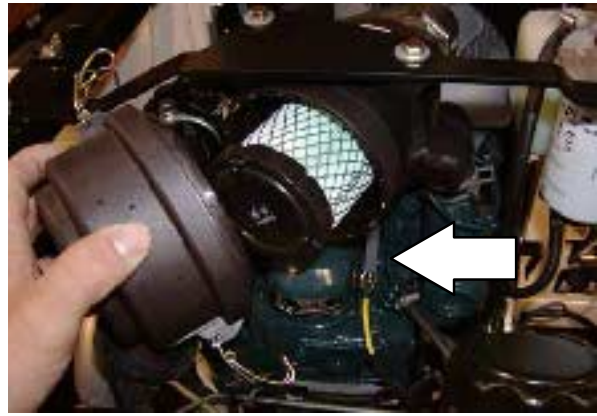

- Check the engine oil level.



- Check the fuel level.

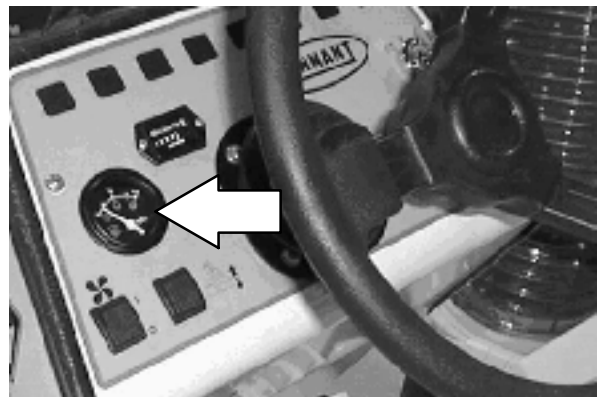

- Check the brakes and steering for proper operation.

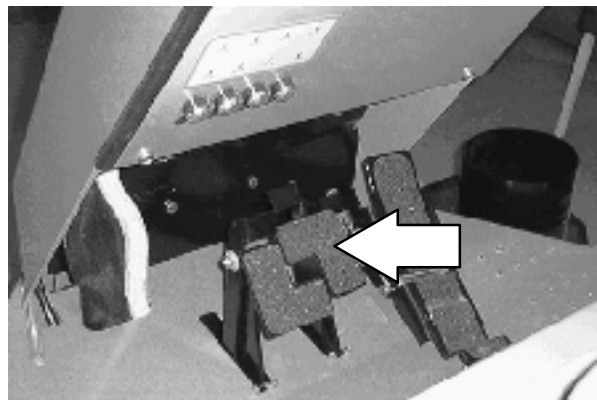

OPERATION

- Check the coolant level in the overflow reservoir.

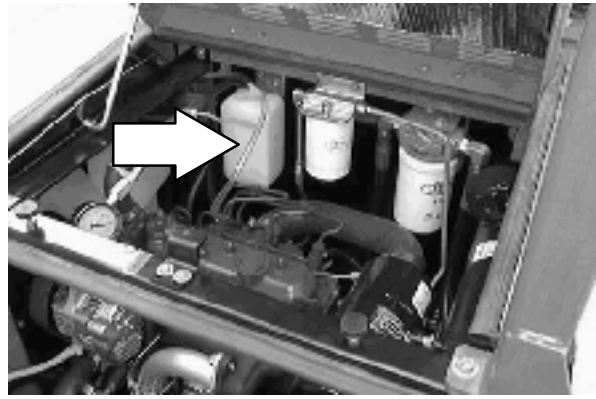

- Check the radiator inlet screen for debris, and clean if required.



- Check the vacuum bag for debris, and empty if required.

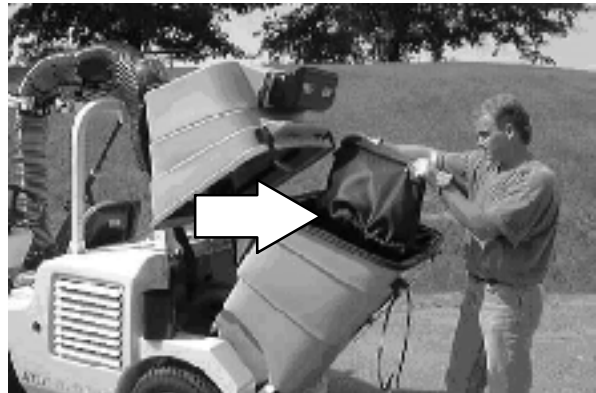

- Check the water dust control tank, fill if required. (Option)

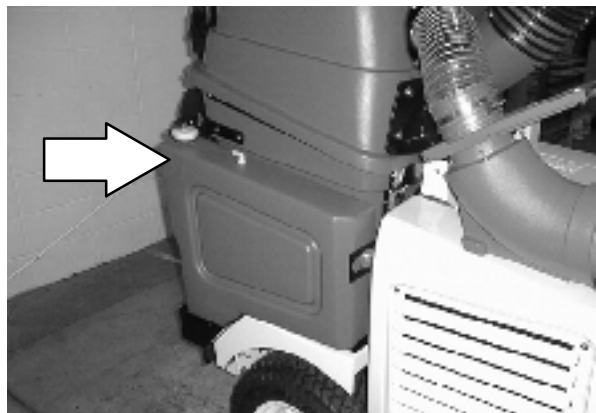

- Check the vacuum fan screen for debris, and *gently* clean with a broom if required.

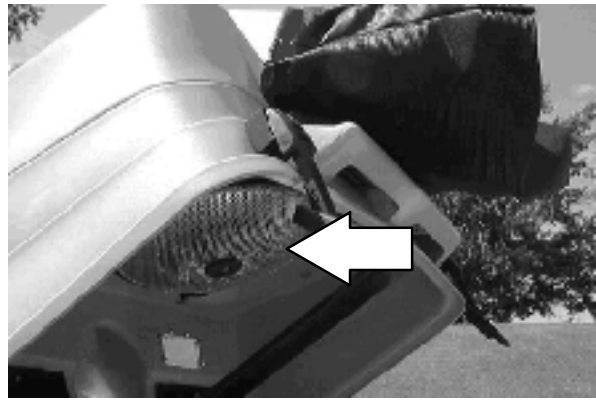

- Check the hopper, empty if required.



- Check the vacuum hose for damage, cracks and lodged debris.

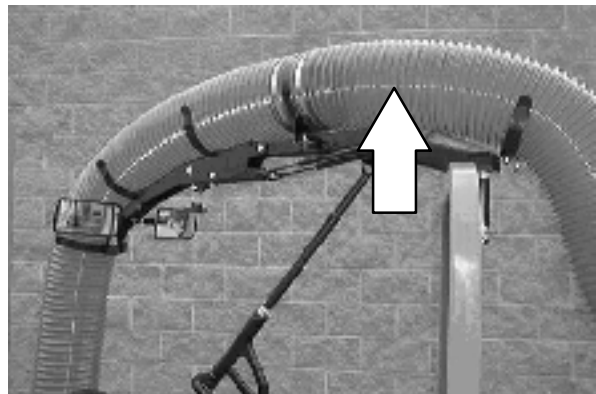

OPERATION

- Check the vacuum hose support arm for proper adjustment.

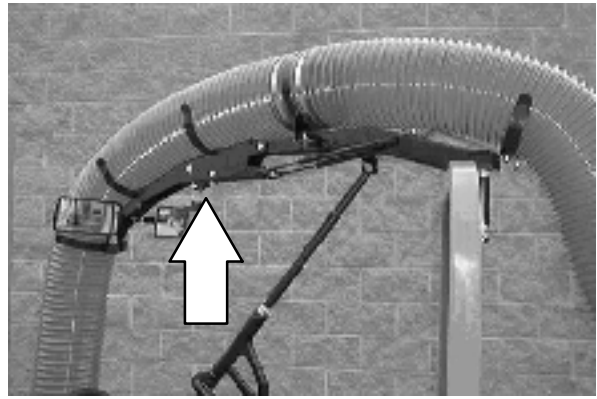

- Check the vacuum wand handle for proper adjustment.

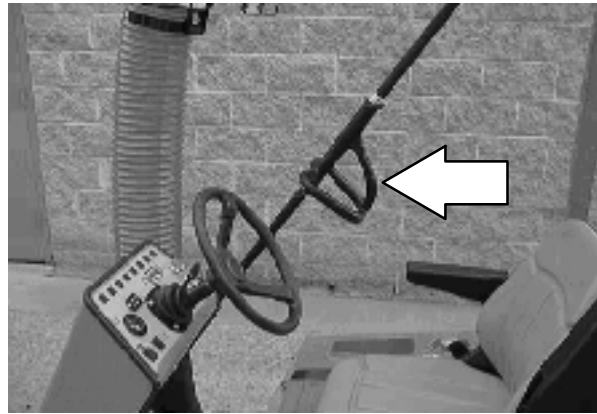

- Check the vacuum head skirts for wear. (Option)

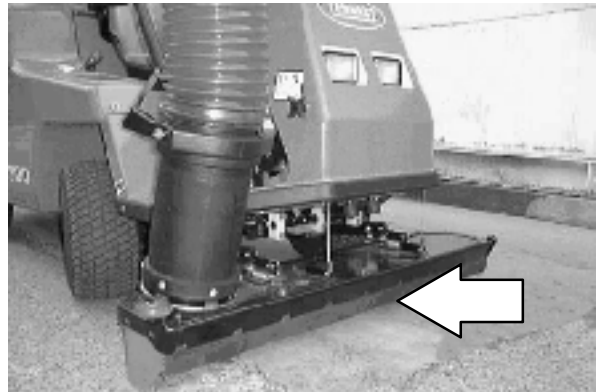

STARTING THE MACHINE

1. Check the directional pedal to make sure it is in the middle neutral position.

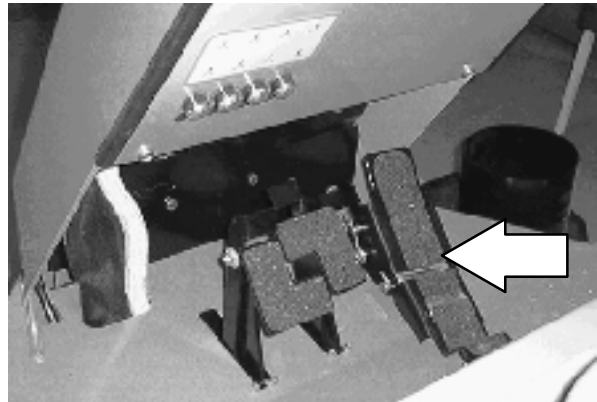

2. Sit in the operator's seat with your foot on the brake pedal or with the parking brake set.

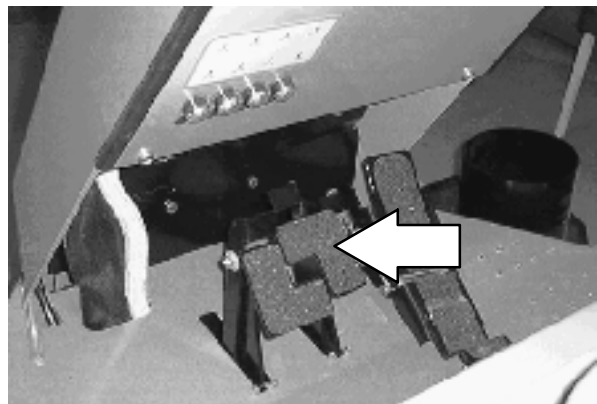

3. Put on the seat belt.

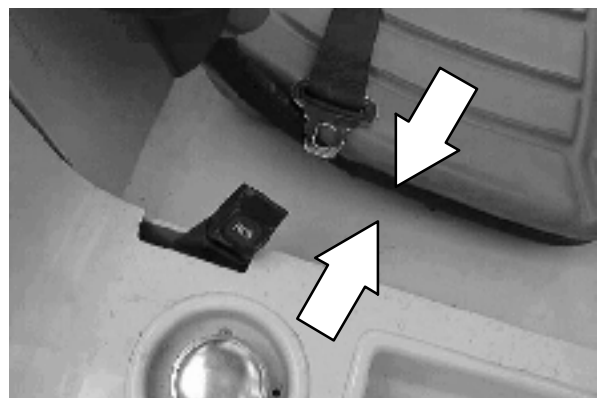

OPERATION

4. Move the throttle lever back to the **idle engine speed** position.



5. Turn the key counter-clockwise. The glow plug light will come on. Hold the key in this position until the light goes out. The engine is now ready to start.

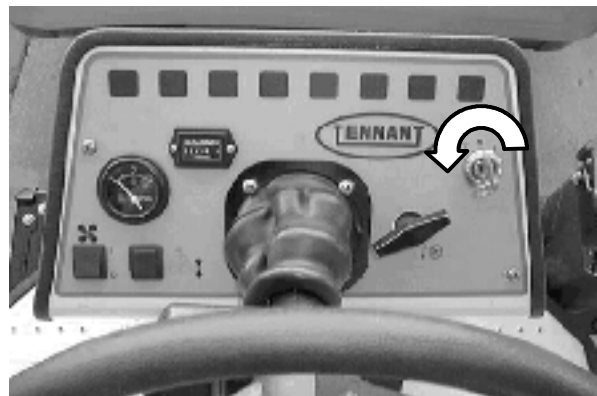

6. Turn the ignition switch key clockwise until the engine starts.

Note: Do not operate the starter motor for more than 10 seconds at a time or after the engine has started. Allow the starter to cool between starting attempts or damage to the starter motor may occur.

7. Allow the engine and hydraulic system to warm up three to five minutes.

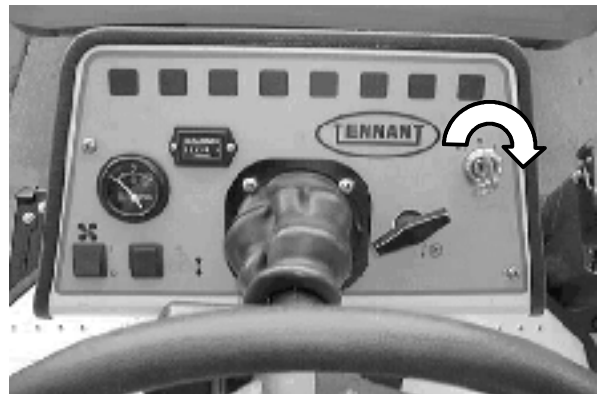

⚠ WARNING: Engine Emits Toxic Gases. Severe Respiratory Damage Or Asphyxiation Can Result. Provide Adequate Ventilation. Consult With Your Regulatory Agency For Exposure Limits. Keep Engine Properly Tuned.

8. Vacuum head option: Place the vacuum hose on to the vacuum head opening.

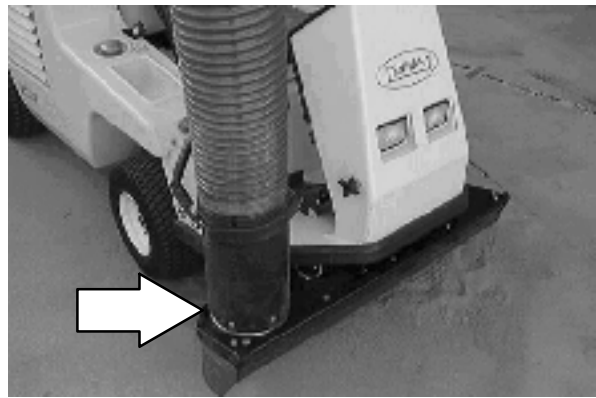

9. Step on the brake pedals firmly to release the parking brake.

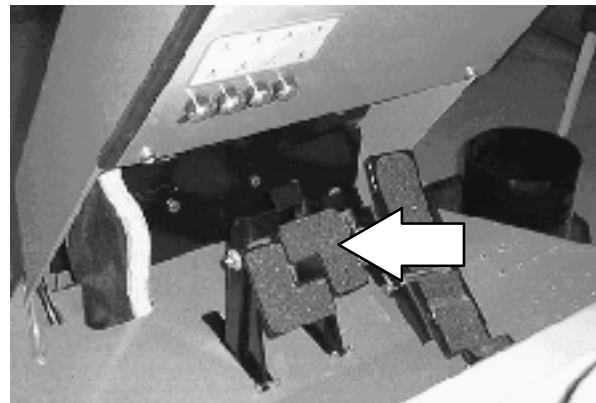

OPERATION

10. Vacuum head option: Raise the vacuum head by pressing the bottom of the vacuum head switch.

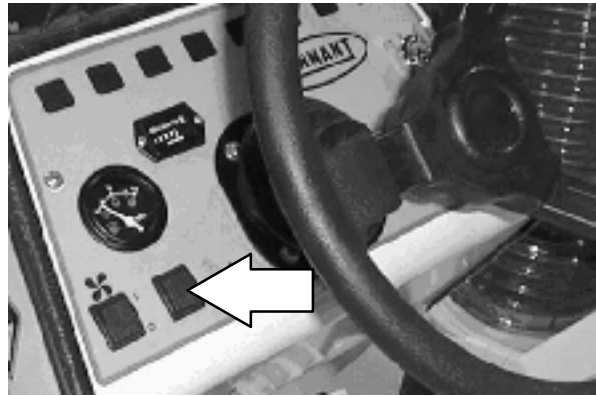

11. Push the throttle lever forward to the middle operating position.



12. Step on the directional pedal and drive the machine to the area to be vacuumed.

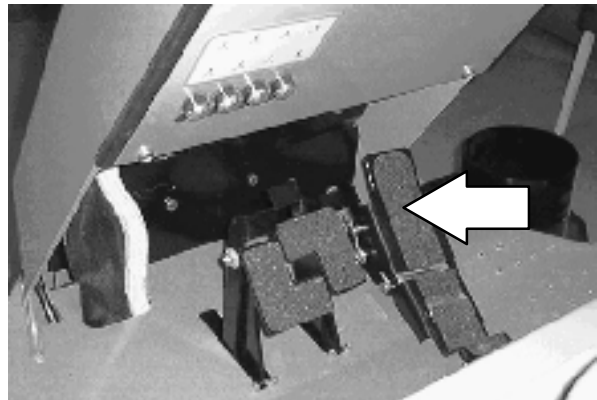

VACUUMING AND HOSE INFORMATION

The model 4300 has a GVWR of 1180 kg (2,600 lb.) Operate only on surfaces capable of supporting this weight.

Never carry passengers.

FOR SAFETY: When using machine, do not carry riders on machine.

Never vacuum burning or smoldering debris.

Plan the vacuuming in advance.

Slow down before turning. Avoid turning the steering wheel too sharply when the machine is in motion. The machine is very responsive to the movement of the steering wheel. Avoid sudden turns, except in emergencies.

Do not operate machine in reverse unless absolutely necessary.

When driving in reverse, check carefully in mirrors and behind hopper. Always look down and backwards before and while backing.

FOR SAFETY: When using machine, use care when reversing machine.

Watch for traffic when operating near or crossing roadways.

FOR SAFETY: When using machine, always follow safety and traffic rules.

Do not vacuum all debris at full power. Excess vacuum power may pick up finer debris such as dirt and sand resulting in more frequent stops to empty a much heavier hopper.

Use throttle speed 1 for normal operation, and speed 2 when extra pick up is required.

For best results, maneuver the vacuum hose as close to debris as possible. Air flow picks up the debris, the vacuum doesn't. Hold the hose end a few inches off the ground to allow air to enter the hose when picking up debris.

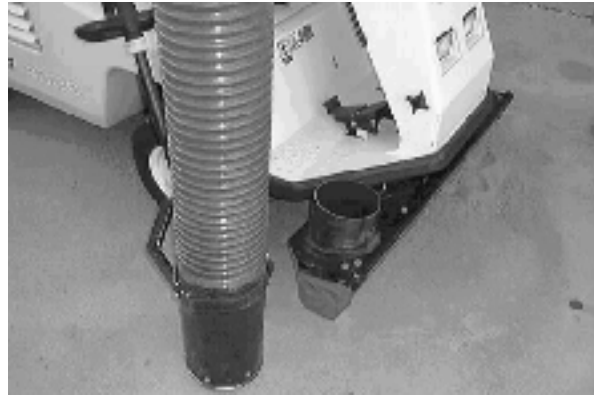

OPERATION

Avoid bulky debris that may block vacuum hose; tree branches, wire or large debris. Bulky items can sometimes clog in the vac head; remember to watch to see that they go up the hose and if not, remove the hose and check for clogs.

Never leave a running machine unattended. Always turn off fan, set parking brake, stop engine, and remove keys before dismounting.

FOR SAFETY: Before leaving or servicing machine, stop on level surface, set parking brake, turn off machine, and remove key.

Always shut off vacuum fan and engine before unclogging debris.

Turn off the vacuum fan and shut down the engine before emptying vacuum bag or opening the debris hopper.

 **WARNING: Spinning fan. Stop engine before opening debris canister.**

The rotating fan in the top of the debris canister can become clogged with light debris. Clean with a broom when emptying bags.

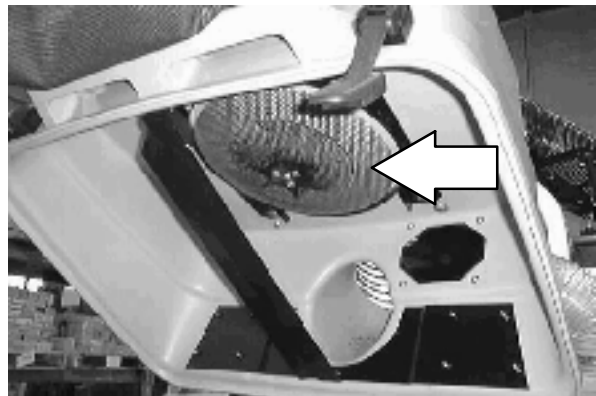

OPERATION ON INCLINES

The maximum rated incline for the machine is 12° / 21%.

Turn the vacuum fan off when propelling up steep inclines.

Slopes are a major factor related to loss-of-control and tip-over accidents, which can result in severe injury or death. All slopes require extra caution. If you cannot back up the slope or if you feel uneasy on it, do not operate the machine on it.

FOR SAFETY: When using machine, go slow on inclines and slippery surfaces.

Drive the machine slowly on inclines and curbs. Use the brake pedals to control machine speed on descending inclines.

Keep all movement on any slope or incline slow and gradual. Do not make sudden changes in speed or direction.

Operate the machine up and down slopes, not across them.

Avoid starting or stopping on a slope. If tires lose traction, proceed slowly straight down the slope.

Do not operate the machine without wearing the seat belt.

Do not turn on slopes unless necessary, and then turn slowly and gradually downhill.

Do not operate the machine on drop-offs, ditches, or embankments. The machine could suddenly turn over if a wheel is over the edge of a cliff or ditch, or if an edge caves in.

Do not operate on wet grass. Reduced traction could cause sliding.

Do not try to stabilize the machine by placing a foot on the ground.

Do not drive the machine with the hopper open.

FOR SAFETY: When Using Machine, Do Not Move Machine With Hopper Open.

OPERATION OVER CURBS

The ATLV can climb over curbs up to 178 mm (7 in) tall. Do not attempt to drive over obstacles at full speed.

Turn off the vacuum fan and raise the vacuum head before climbing curbs or obstacles.

Always approach a curb at a 45° with a front tire at slow speed. Use brake pedals if necessary to divert propelling power from one tire to another.

Drive the machine slowly over curbs. Use the brake pedal to control the machine speed when climbing over any obstacles.

Driving over any curb requires extra caution. Do not try to stabilize the machine by placing a foot on the ground when climbing over curbs.



VACUUMING

1. Start the machine. Refer to the STARTING THE MACHINE section of this manual.

 **WARNING: Engine Emits Toxic Gases. Severe Respiratory Damage Or Asphyxiation Can Result. Provide Adequate Ventilation. Consult With Your Regulatory Agency For Exposure Limits. Keep Engine Properly Tuned.**

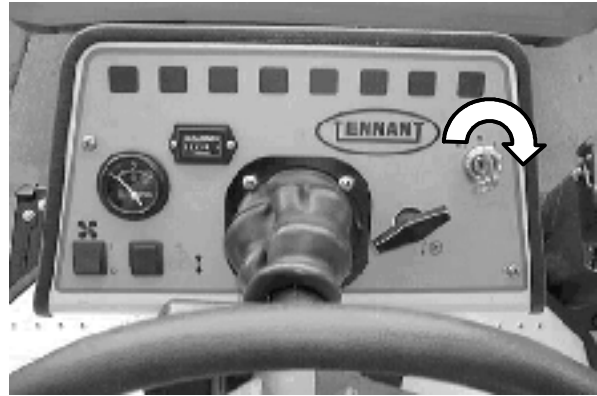

2. Take a firm hold of the vacuum wand handle.

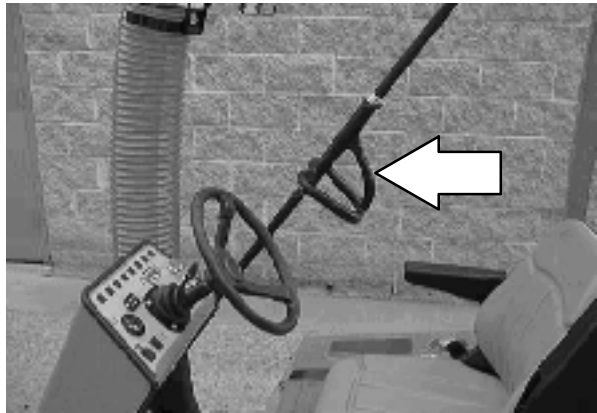

3. Vacuum head option: Place the vacuum hose on to the vacuum head opening.

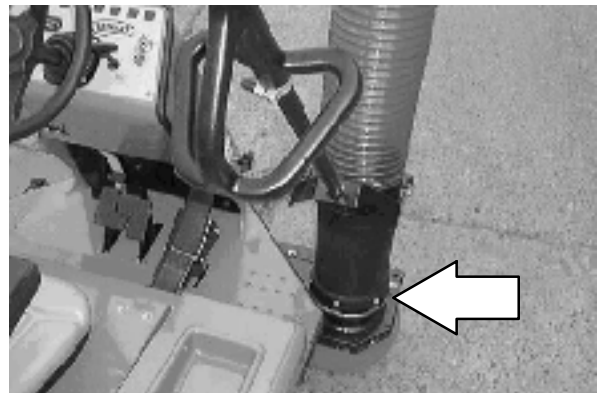

OPERATION

4. Lower the vacuum head to desired head height and adjust the stop.

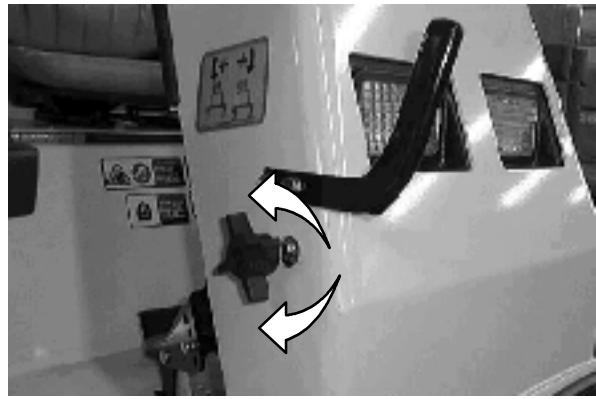

5. Drive the machine to designated area to be vacuumed.

6. Turn the vacuum fan switch on.

⚠ WARNING: Machine Can Emit Excessive Noise. Consult With Your Regulatory Agency For Exposure Limits. Hearing Loss Can Result. Wear Hearing Protection.

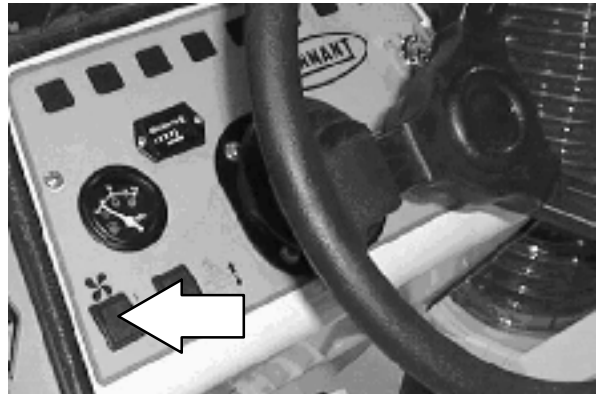

7. Move the throttle lever forward until desired vacuum power is reached by vacuum.

Note: Light debris can be vacuumed with the throttle in the middle speed 1 position. Heavy debris can be vacuumed with the throttle in the forward speed 2 position.



8. Water dust control option: Press forward on the water dust control switch to turn the water dust control on.

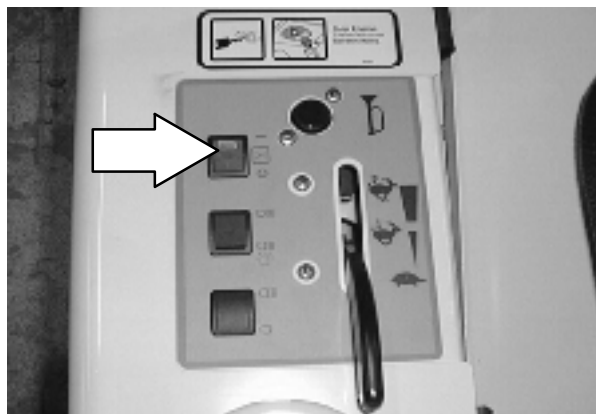

9. Push down on the directional pedal and begin vacuuming.

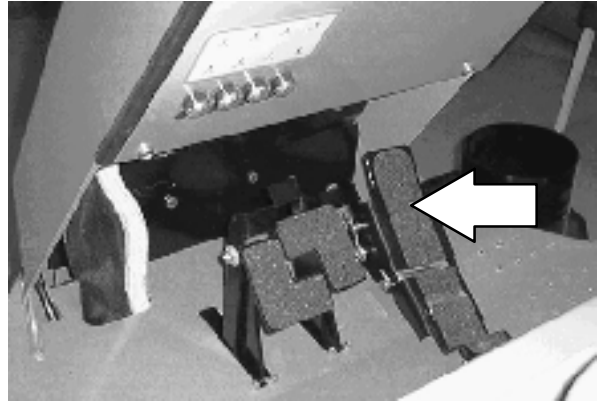

10. Remove the vacuum hose from the vacuum head to collect debris as needed: Push forward and up on the vacuum wand handle, and lift the vacuum hose off the vacuum head.

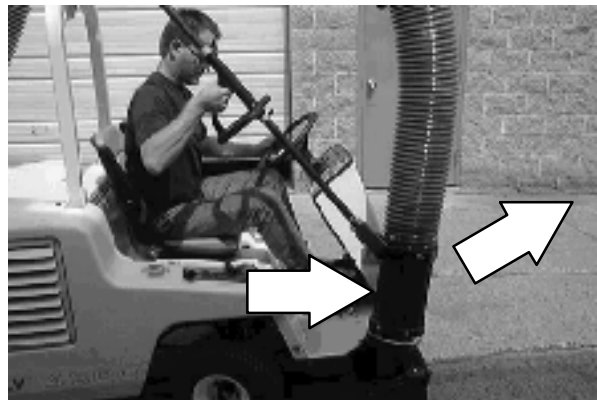

OPERATION

STOP VACUUMING

1. Press the bottom of the vacuum fan switch to turn the vacuum fan off.

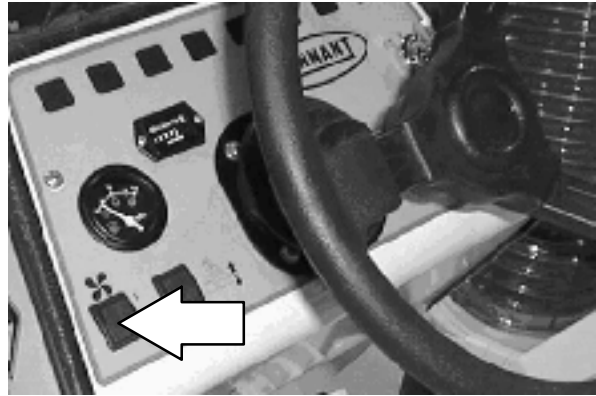

2. Vacuum head option: Press the bottom of the vacuum head switch to raise the vacuum head.

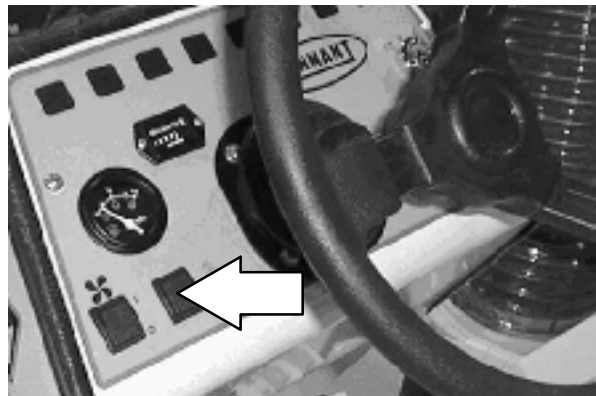

3. Water dust control option: Press backward on the water dust control switch to turn the water dust control off.

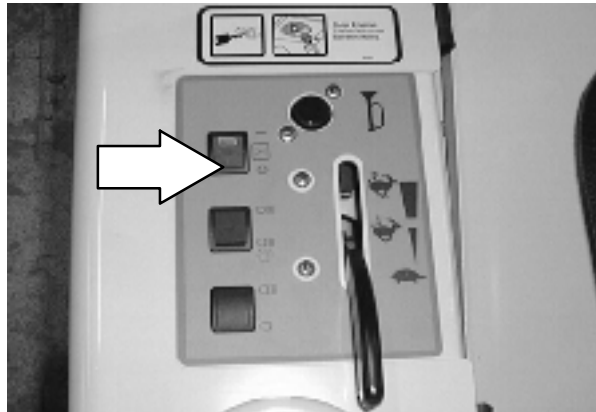

4. Push throttle lever to desired engine speed.



5. Drive the machine to designated hopper unloading area. Set parking brakes and shut off machine.

FOR SAFETY: Before leaving or servicing machine, stop on level surface, set parking brake, turn off machine and remove key.

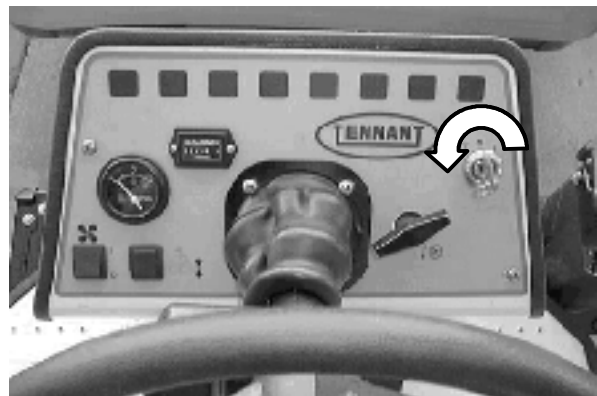

OPERATION

STOPPING THE MACHINE

1. Stop vacuuming. Refer to the STOP VACUUMING section of this manual.
2. Take your foot off the propelling pedal. Step on the brake pedals.

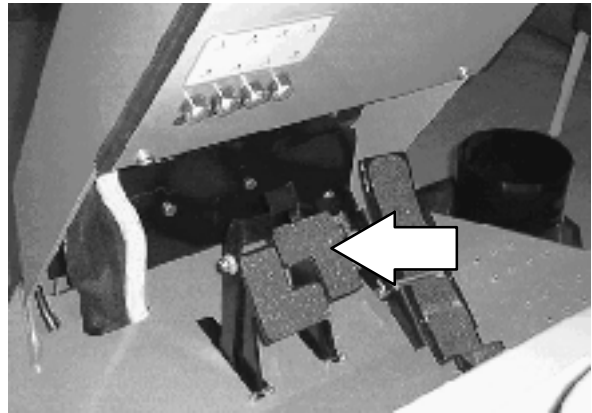

3. Move the throttle lever back to the idle position.



4. Set the parking brakes.

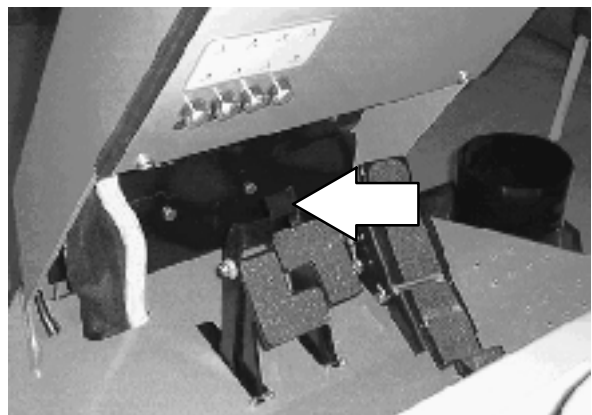

5. Turn the ignition switch key counter-clockwise to stop the engine. Remove the switch key.

FOR SAFETY: Before Leaving Or Servicing Machine; Stop On Level Surface, Set Parking Brake, Turn Off Machine And Remove Key.

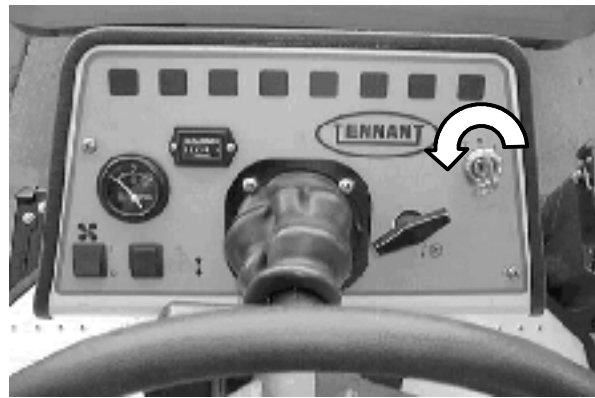

POST-OPERATION CHECKLIST

- Check the vacuum hose for cracks or wear.
- Check vacuum screen for debris.
- Check filter bag for debris and damage.
- Check vacuum wand and vacuum wand handle for proper adjustment.
- Check the vacuum head skirts for damage and wear. (Option)
- Check vacuum support arm for wear and proper adjustment.
- Check for large debris lodged in the vacuum hose.
- Check for fuel odor that indicates a fuel leak.
- Check under the machine for leak spots (fuel, oil, coolant).
- Check the service records to determine maintenance requirements.

EMPTYING THE VACUUM BAG

(For machines below serial number 001070)

1. The *Vacuum Bag* is located on the back of the debris hopper. It collects fine debris that may blow out the fan exhaust outlet. Make sure the machine is turned off and on level ground before emptying the vacuum bag. Refer to the STOP THE MACHINE section of this manual.

FOR SAFETY: When Using Machine, Only Empty The Hopper On A Level Surface.

2. Set the parking brake.

FOR SAFETY: Before leaving or servicing machine, set the parking brake, turn off machine and remove key.

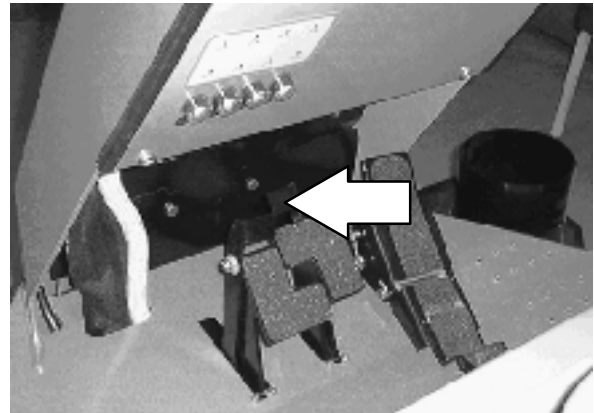

3. Pull the cotter pin out from the quick release strap latch.

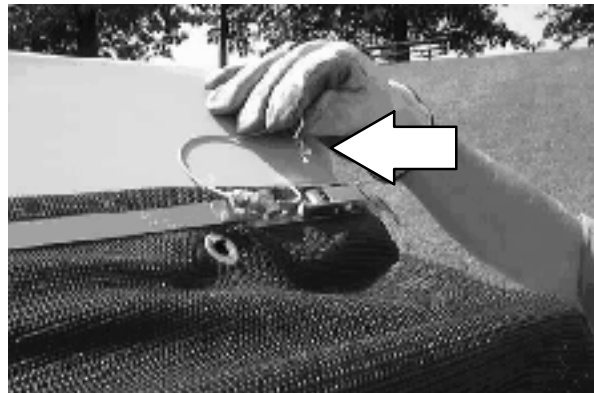

4. Unfasten the latch and remove the quick release strap from the vacuum bag.

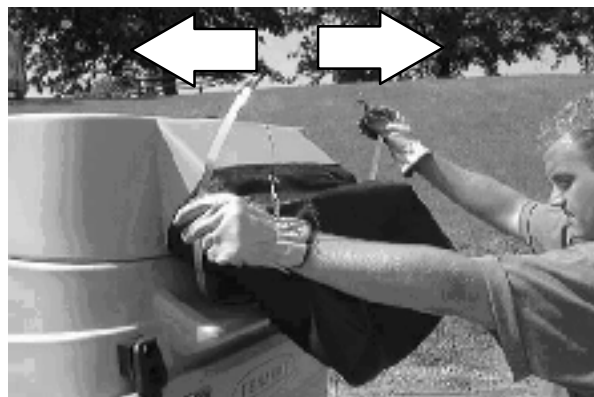

5. Remove the vacuum bag.

⚠ WARNING: Spinning fan. Stop engine before opening debris canister.

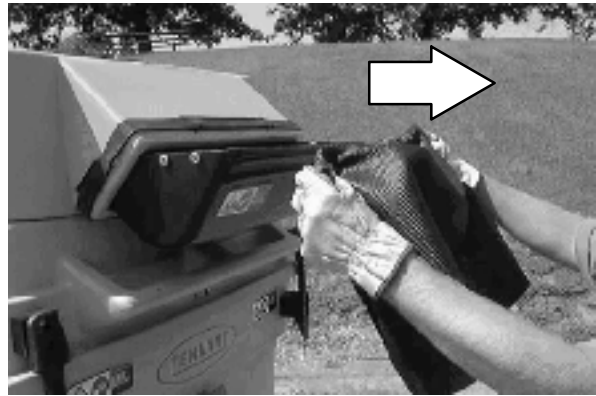

6. Open the hopper. Empty the vacuum bag in the hopper. Close the hopper.

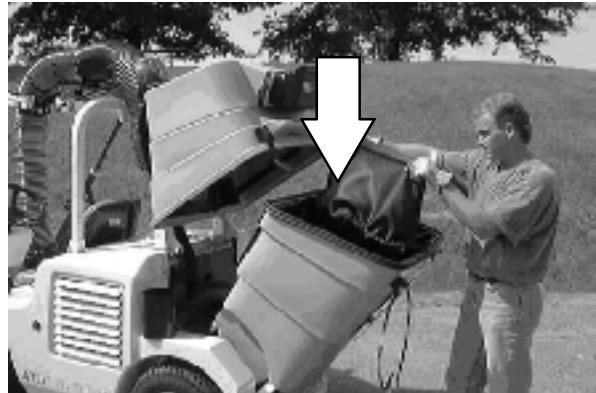

7. Mount the vacuum bag back onto the hopper.

Note: Make certain the vacuum bag is correctly positioned over the four mounting tabs on the fan exhaust outlet before securing with the quick release strap.

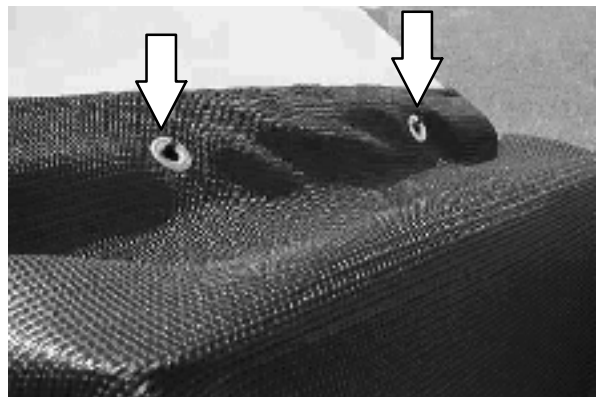

8. Secure the vacuum bag with the quick release strap. Replace the cotter pin in the strap latch after it is closed.

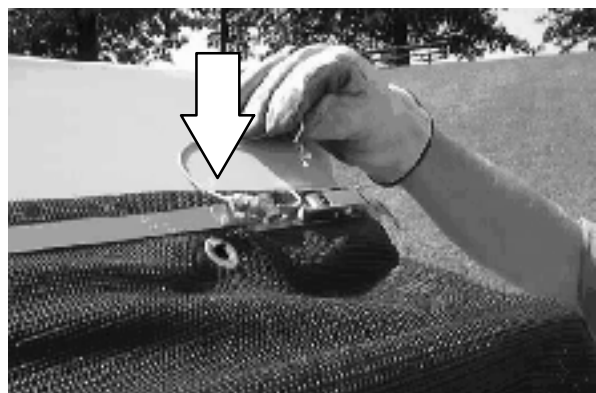

OPERATION

EMPTYING THE VACUUM BAG (For machines with serial number 001070 and above)

1. Set the parking brake.

FOR SAFETY: Before leaving or servicing machine, set the parking brake, turn off machine and remove key.

FOR SAFETY: When Using Machine, Only Empty The Hopper On A Level Surface.

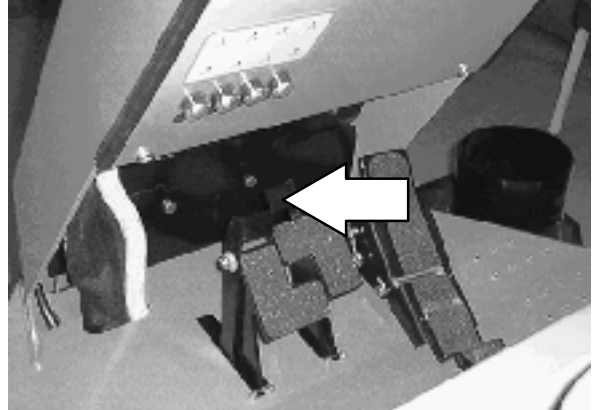

2. Remove the vacuum bag.



3. Open the hopper. Empty the vacuum bag in the hopper. Close the hopper.



4. Mount the vacuum bag back onto the hopper.



EMPTYING THE HOPPER

1. Drive the machine to the debris collection site or debris container. Stop the machine. Refer to the STOP THE MACHINE section of this manual. Make sure the machine is turned off and on level ground before emptying the hopper.

FOR SAFETY: When Using Machine, Only Empty The Hopper On A Level Surface.

2. Set the parking brake.

FOR SAFETY: Before leaving or servicing machine, set the parking brake, turn off machine and remove key.

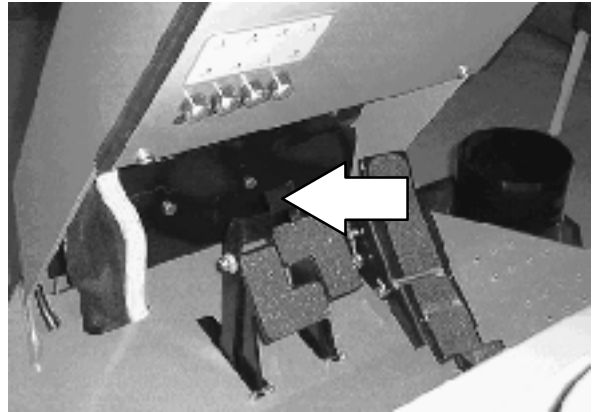

3. Check the vacuum bag for debris. Empty if necessary. Refer to the EMPTYING THE VACUUM BAG section of this manual.

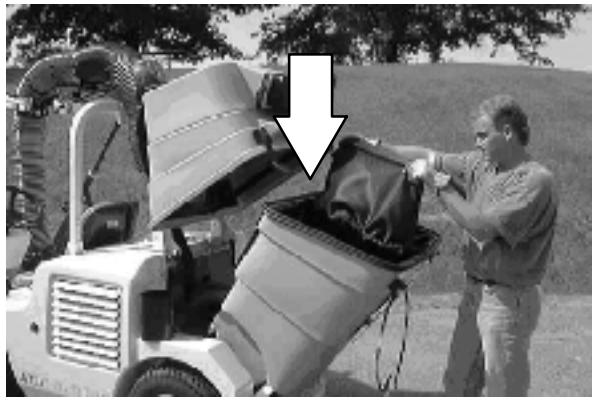

4. Unfasten the hopper latches and lift the hopper cover.



WARNING: Spinning fan. Stop engine before opening debris canister.



WARNING: Sharp objects in debris canister. Wear gloves.



OPERATION

5. Lower the hopper until the hopper tilt bracket holds it in the *bag tying position*. Remove the hopper bag liners.

Note: The hopper bag liners will only fit in the hopper one way. Note which direction upon removal.

FOR SAFETY: Do Not Move The Machine When Hopper is Lowered.



6. Tie off the bags.

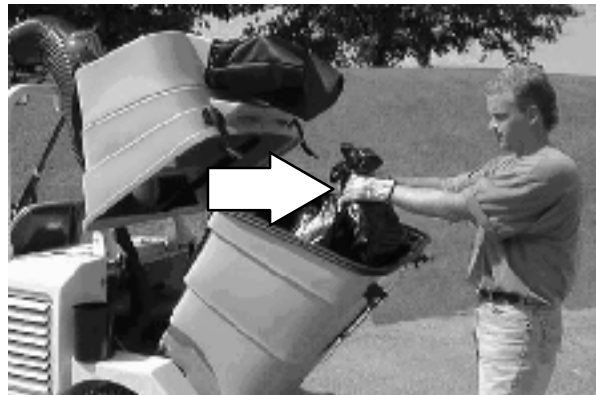

7. Push the hopper down until it “snaps” free of the hopper tilt bracket and is held by the cannister cables in the *debris removing position*. Remove and dispose of the full debris bags.

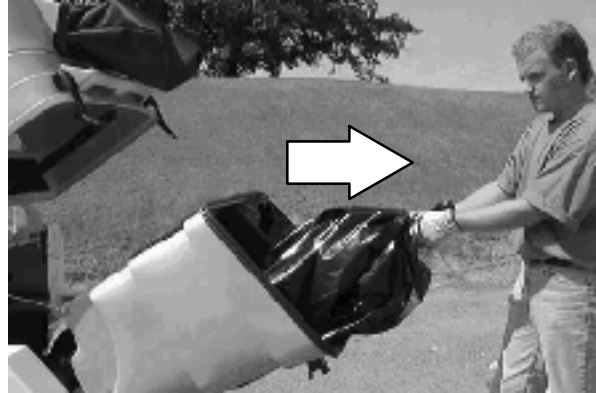

8. Place the new bags over the bag liners and insert them in the hopper.

Note: Bag liners will only fit in the debris hopper one way. Note which direction upon removal.



9. Fold excess bag over the edges of the hopper.



10. Check the vacuum fan screen for debris. Gently clean with a stiff broom or brush if necessary.

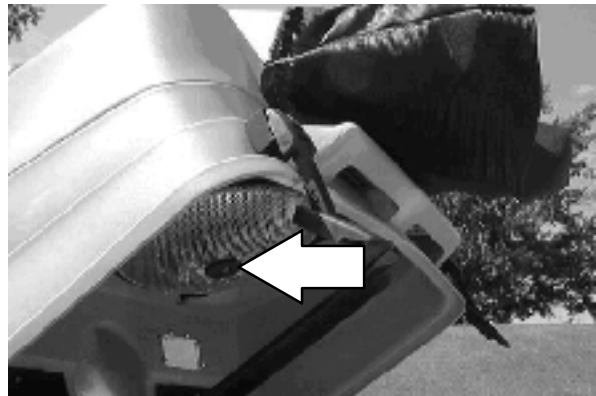

11. Close the hopper and fasten the hopper latches.

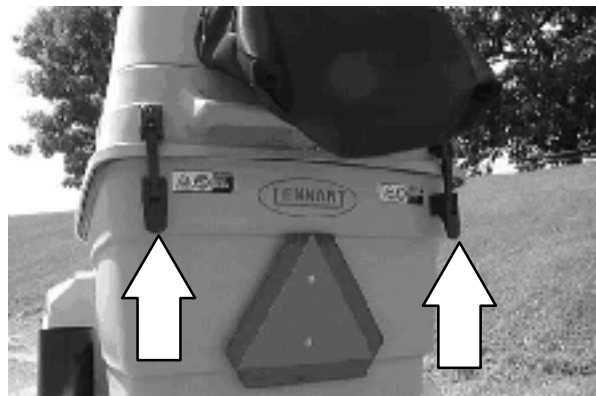

OPTIONS

4 POST ROPS AND WEATHER SHIELD (OPTION)

The 4 Post ROPS (Roll Over Protection System) and Weather Shield allows the operator to work in the shelter of a safer, weather protected environment.



The 4 Post ROPS and Weather Shield has a two speed windshield wiper on the front window. The control knob for the windshield wiper is in the operator's compartment.

Wiper on low: Turn the knob one click to the right.

Wiper on high: Turn the knob two clicks to the right.

Wiper off: Turn the knob all the way to the left.

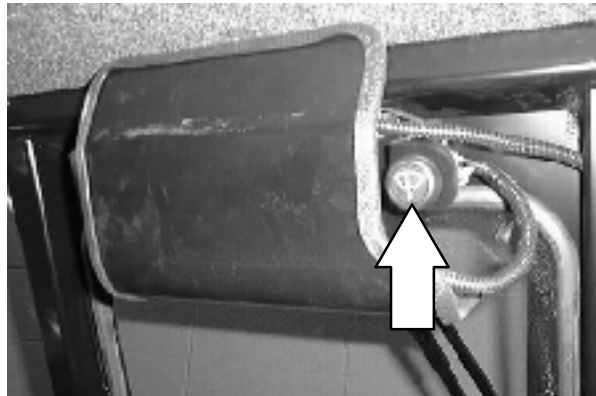

WATER DUST CONTROL (OPTION)

The wet dust control option helps to remove fine debris and dust particles from the air while the machine is operating.

FILLING THE WATER TANK:

1. Drive the machine to an accessible water supply hose. Stop the machine and apply the parking brake. See the STOPPING THE MACHINE section of the manual.

FOR SAFETY: Before leaving or servicing machine, stop on level surface, set parking brake, turn off machine, and remove key.

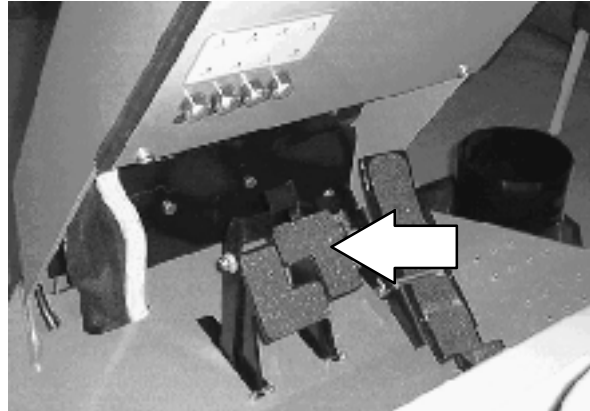

2. Fill the water tank. The fill cap is located on the top of the tank on the right hand side of the machine.

Note: The water dust control system will stop if the water tank runs dry during operation. If this happens, return to the water supply and refill the tank. Turn the water pump switch off and back on again to reset the switch.

3. Start the machine, release the parking brake and begin vacuuming. See the VACUUMING section of the manual.

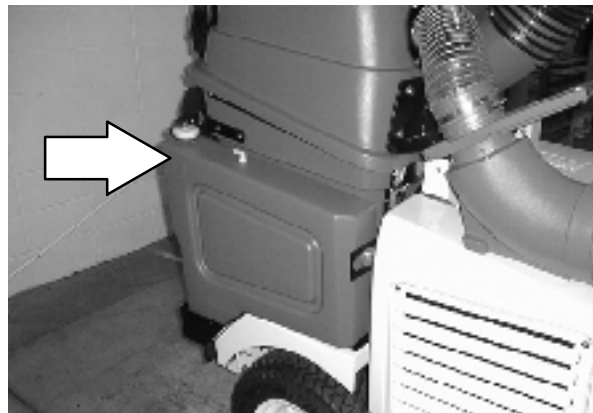

OPERATION

VACUUM HEAD (OPTION)

The *Vacuum Head* option allows the operator to vacuum without having to manipulate the vacuum hose. The vacuum hose easily attaches to the vacuum head. The vacuum head has an adjustable *down stop* which can be set so the operator may return the vacuum head to normal operating position after raising the head to let in bulky debris or for climbing a curb.

Note: The vacuum head should be raised while driving machine to and from area to be vacuumed. Raise vacuum head when driving over curbs and up and down ramps.

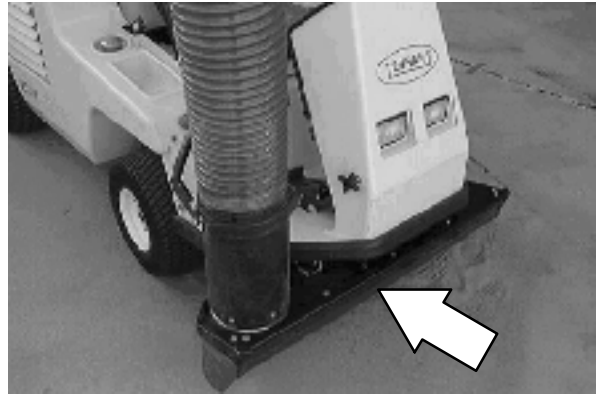

TO ADJUST VACUUM HEAD DOWN STOP:

1. Press the top of the vacuum head switch to lower the vacuum head.

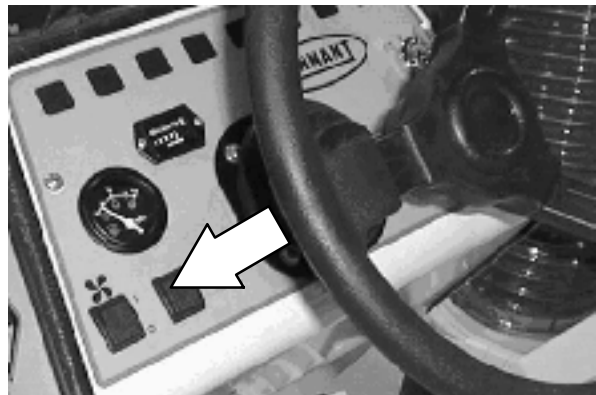

2. Adjust down stop height with *vacuum head adjustment knob*.

Raise vacuum head adjustment: Turn the knob counterclockwise.

Lower vacuum head adjustment: Turn the knob clockwise.

Note: When adjusted properly, the rear skirt of the vacuum head should be rolled out about 13mm (.50 in) in the rear on a flat hard surface.



3. Press the bottom of the vacuum head switch to raise the vacuum head. Vacuum head height is now set for next use.

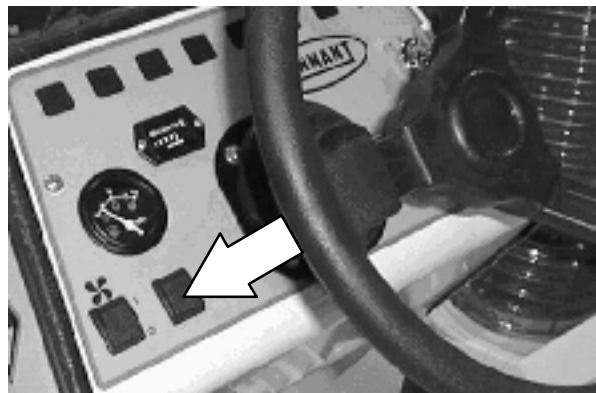

DUST FILTER BAG (OPTION)

The *Dust filter bag* option filters more dust and fine particles out of the air when operating the machine. The dust filter bag easily mounts to the debris hopper in place of the standard filter bag.

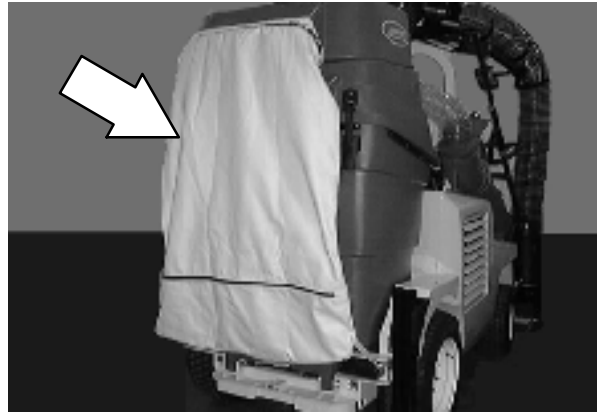
**EMPTYING THE DUST FILTER BAG:**

1. Unhook each clip of the dust filter bag securing straps from the holding brackets on each side of the debris hopper.



2. Open the dust filter bag zipper.

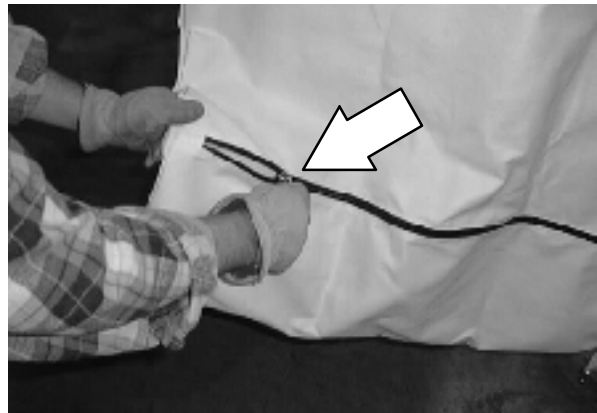

3. Pull up on the dust filter bag high enough to pull the vacuum bag out of the dust filter bag.



OPERATION

4. Open the vacuum bag zipper and let the debris fall out of the vacuum bag.
5. Close the vacuum bag zipper and insert back into dust filter bag.

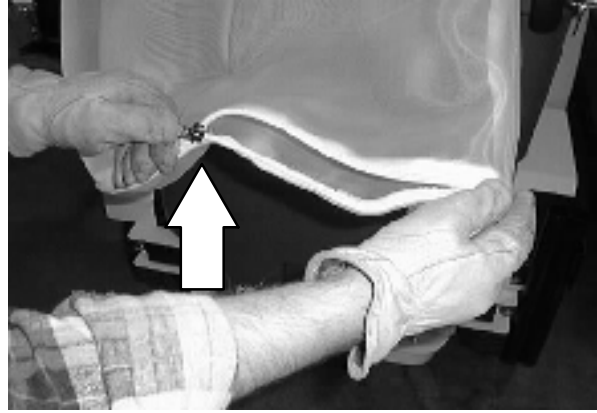

6. Empty dust filter bag.
7. Close the dust filter bag zipper.

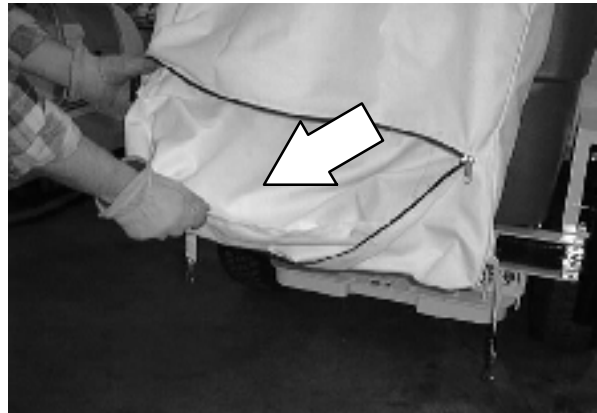

8. Hook each clip of the dust filter bag securing straps to the holding brackets on each side of the debris hopper.

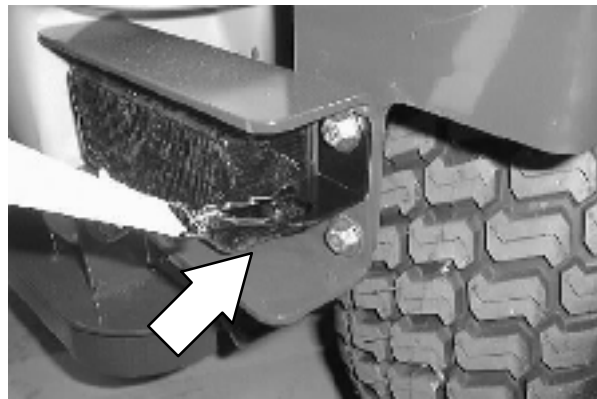

VACUUM WAND w/ 15 FOOT EXTENSION (OPTION)

The *vacuum wand w/ 15 foot extension* helps the operator reach into tight areas, where it may be difficult to reach debris with the machine's vacuum hose.

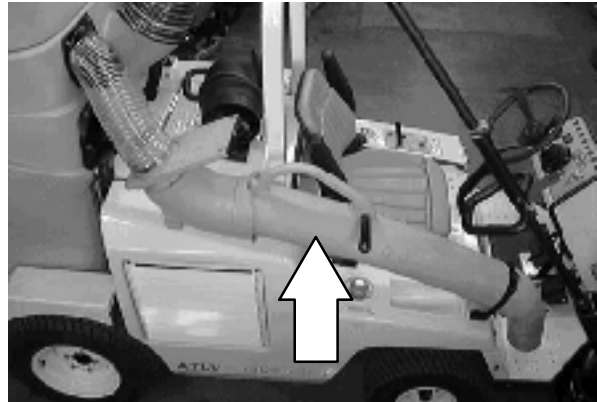

TO OPERATE VACUUM WAND W/15 FOOT EXTENSION:

1. Start the machine. Refer to the STARTING THE MACHINE section of this manual.

⚠ WARNING: Engine Emits Toxic Gases. Severe Respiratory Damage Or Asphyxiation Can Result. Provide Adequate Ventilation. Consult With Your Regulatory Agency For Exposure Limits. Keep Engine Properly Tuned.

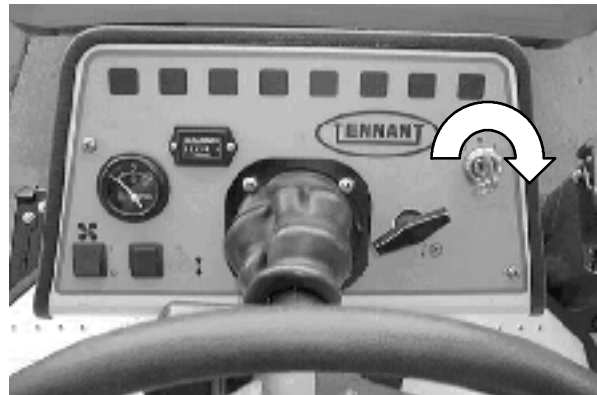

2. Turn the vacuum fan switch on.

⚠ WARNING: Machine Can Emit Excessive Noise. Consult With Your Regulatory Agency For Exposure Limits. Hearing Loss Can Result. Wear Hearing Protection.

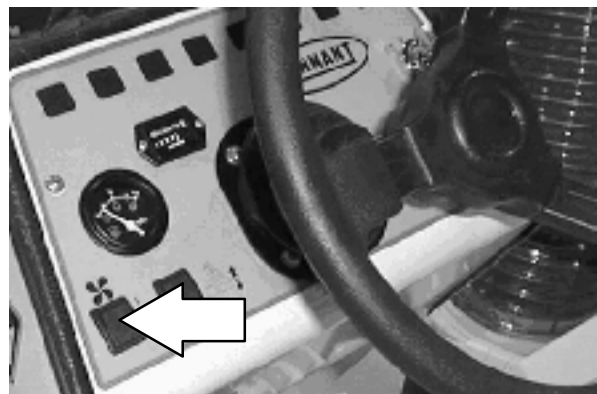

OPERATION

3. Open the vacuum wand hose push/pull valve to direct the vacuum power to the vacuum hose.
4. Remove the vacuum wand from the mounting plate and begin vacuuming.

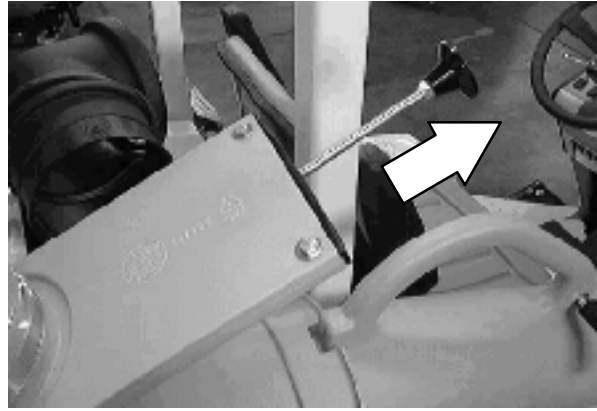

5. If more suction is needed in the vacuum wand, close the gate valve in the main vacuum hose. This will direct all vacuum power to the vacuum wand.

Note: Do not close both of the vacuum wand and main vacuum hose push/pull gate valves with the vacuum fan running. Damage to the hopper and/or hopper seals may occur.

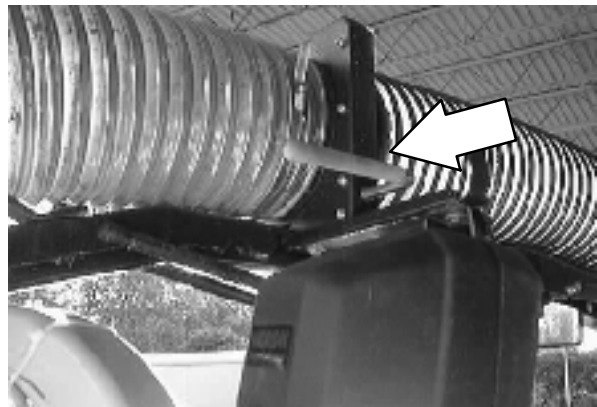

6. When finished vacuuming, cover the vacuum wand opening, or place the opening on a clean flat surface to help retract the vacuum wand hose.
7. Push the push/pull valve in to shut off power to the vacuum wand.
8. Secure the vacuum wand in place on the mounting plate.

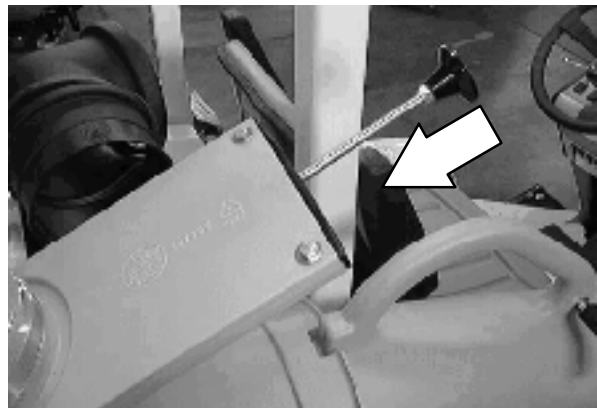

FENCE LINE ATTACHMENT (OPTION)

The *fence line attachment* is a 90° elbow that directs the vacuum hose power to debris caught along fence lines and hedge rows.

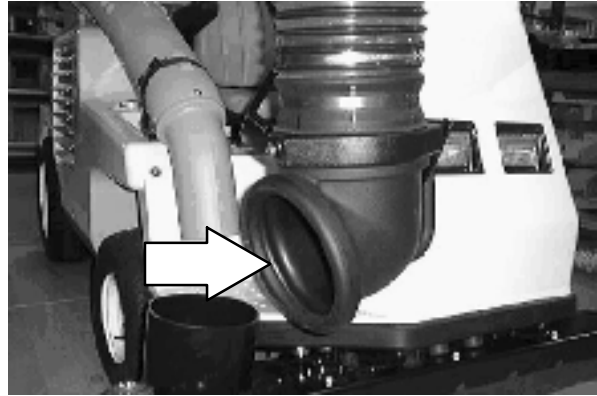
**TO INSTALL FENCE LINE ATTACHMENT:**

1. Remove elbow from fence line elbow tie down bracket.
2. Remove the clamp securing the vacuum hose to the end tube.



3. Lift the vacuum hose and end tube split ring off the end tube.



OPERATION

4. Lift the slip ring and yoke off the end tube.
Mount the end tube on the fence line elbow
tie down bracket when not in use.

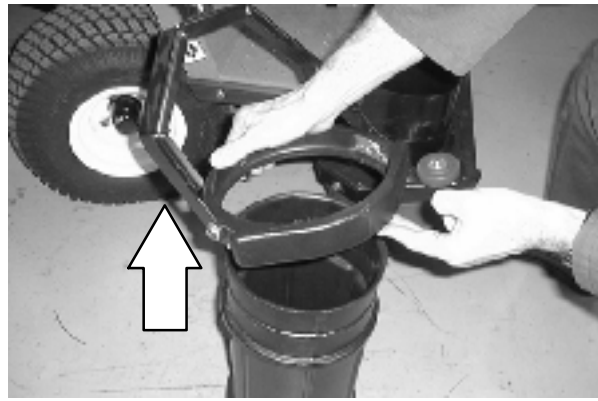

5. Place the slip ring and yoke over the fence elbow attachment.



6. Secure the vacuum hose to the elbow with
the fence elbow split ring and securing
clamp.



7. Hang vacuum wand elbow on elbow bracket
when not in use.



PANEL FILTER KIT (OPTION)

The panel filter kit option helps to remove fine debris and dust particles from the air while the machine is operating.

To maximize performance and run time between filter cleaning, use the main vacuum hose to spot pick litter out of areas of severe dust.

Use the lower throttle speed 1 when possible – so the machine takes less dust into the panel filter.

Vacuum with the bypass door open when dust control is not required – this will insure maximum run time between filter cleaning.

Purchase a spare filter panel for quick change out in the middle of a shift. Both filters can then be washed out at the end of the day and allowed to dry overnight.

**EMPTYING VACUUM BAG:**

1. When the vacuum bag becomes full, shut off the vacuum fan, turn off the machine set the parking brake and remove key.

FOR SAFETY: Before leaving or servicing machine, set the parking brake, turn off machine and remove key.

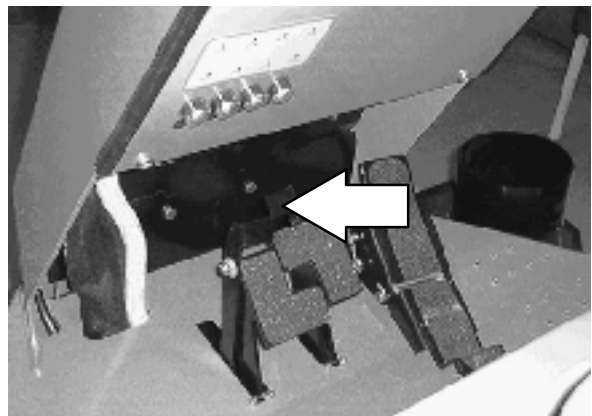

2. Open the bypass door on the bottom of the filter housing by pulling the two latch handles down and rotating them 90°. This will allow debris to fall from the filter housing.

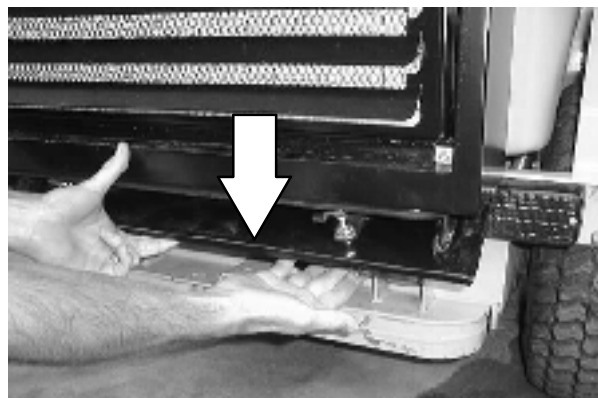

OPERATION

3. Open the latches on the louver panel by pulling the rear of the latch away from the filter housing, and then unhooking the front of the latch from the keeper.
4. Remove dust panel filter.



5. Open the vacuum bag zipper and empty bag through bypass door located at the bottom of the filter panel housing. Close the vacuum bag zipper.



6. Return dust panel filter with the seals toward the filter housing. The filter pleats should be orientated vertically which allow more effective cleaning of the filter. Close the latches.

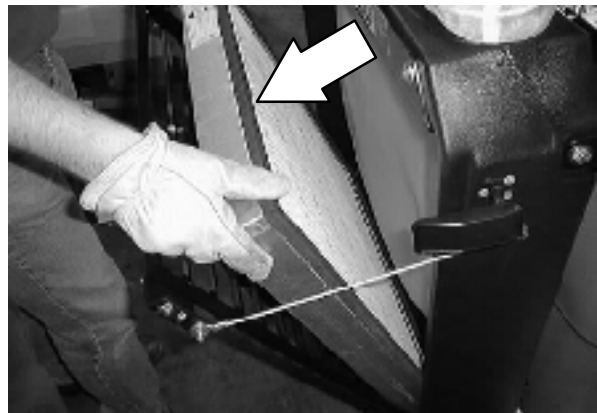

7. Close the bypass door on the bottom of the filter housing.

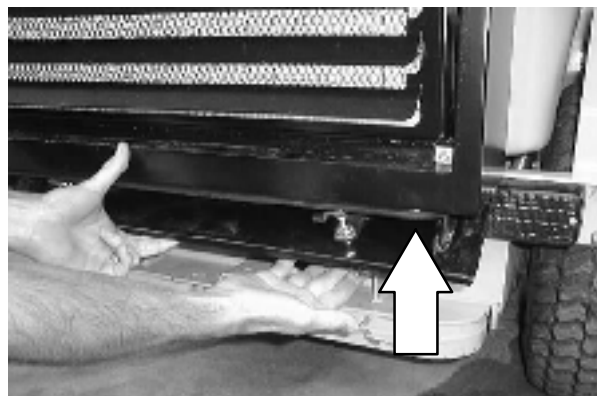

CLEANING THE PANEL FILTER:

The panel filter is a synthetic material that can be washed out with water.

Note: Do not use a high pressure washer as it may tear or otherwise damage the filter media.

To wash the panel filter without removing it from the machine:

1. Open the bypass door on the bottom of the filter housing by pulling the two latch handles down and rotating them 90°. This will allow water to drain from the filter housing.

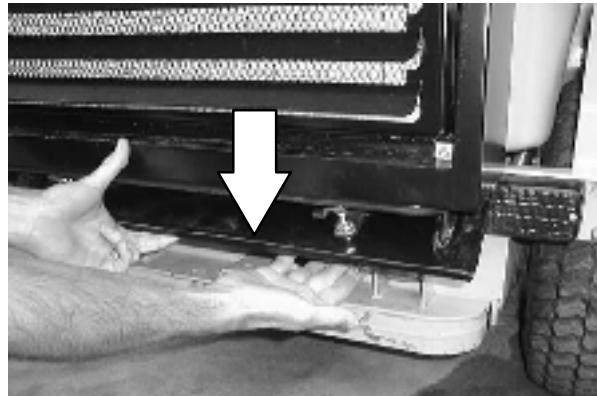

2. Spray the panel out with a garden hose spray nozzle. Dry the panel overnight or by running the vacuum fan until the panel is dry.

Note: Vacuuming debris with a wet panel filter is not recommended and may damage the panel filter.

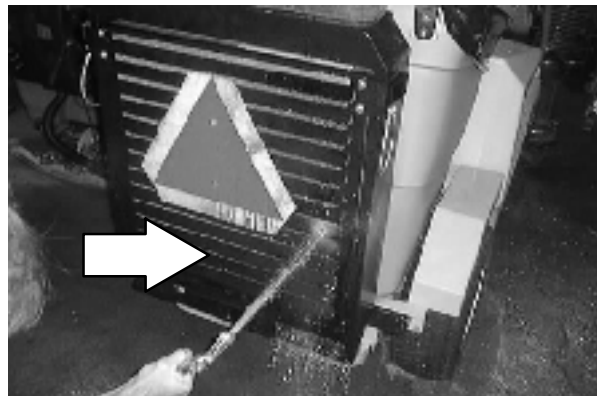

3. If the panel filter becomes clogged during use in the field it can be removed and cleaned by tapping it on the ground. To control dust, first place the filter in a plastic bag.

OPERATION

MACHINE TROUBLESHOOTING

Problem	Cause	Remedy
Machine does not start	Glow plug not warmed up properly	Turn key to warm up glow plug
	Fuel filter plugged	Replace fuel filter
	Fuel pump damaged	Replace fuel pump
Machine propels slowly	Cables not adjusted	Readjust stops or cables
Machine does not propel	Machine not on	Start machine
	Parking brake on	Release parking brake
	Towing valve on	Turn towing valve 90°
Poor vacuum performance	Vacuum head or hose clogged	Remove vacuum head or hose blockage
	Hopper vacuum fan clogged	Clean off fan vacuum screen
	Vacuum head not lowered completely	Lower vacuum head completely
	Vacuum head seals damaged	Replace or repair worn vacuum head seals
	Machine propelling too fast	Slow machine speed
	Vacuum not close enough to debris	Move vacuum closer to debris
	Debris hopper full	Empty debris hopper
	Engine throttle too low	Increase engine throttle
	Vacuum bag (option) clogged	Empty Vacuum bag (option)
	Dust filter bag (option) clogged	Empty dust filter bag (option)
	Panel filter (option) clogged	Clean panel filter (option)
No vacuum power	Hopper Thermo Sentry™ on	Check for fire in hopper
	Solenoid valve not operating	Contact TENNANT service personnel
	Vacuum fan not on	Turn vacuum fan on
	Vacuum fan failure	Contact TENNANT service personnel
	Main vacuum hose gate valve closed	Open main vacuum hose gate valve
Vacuum hose unsupported or too low	Gas cylinders damaged	Contact TENNANT service

Excessive Dusting	Vacuum bag (option) open	Close Vacuum bag
	Panel filter (option) door open	Close panel filter door
	Water dust control (option) not on	Turn on water dust control
	Water dust control (option) water tank empty	Fill water dust control tank
	Water dust control (option) spray nozzle clogged	Clean water dust control spray nozzle

MAINTENANCE

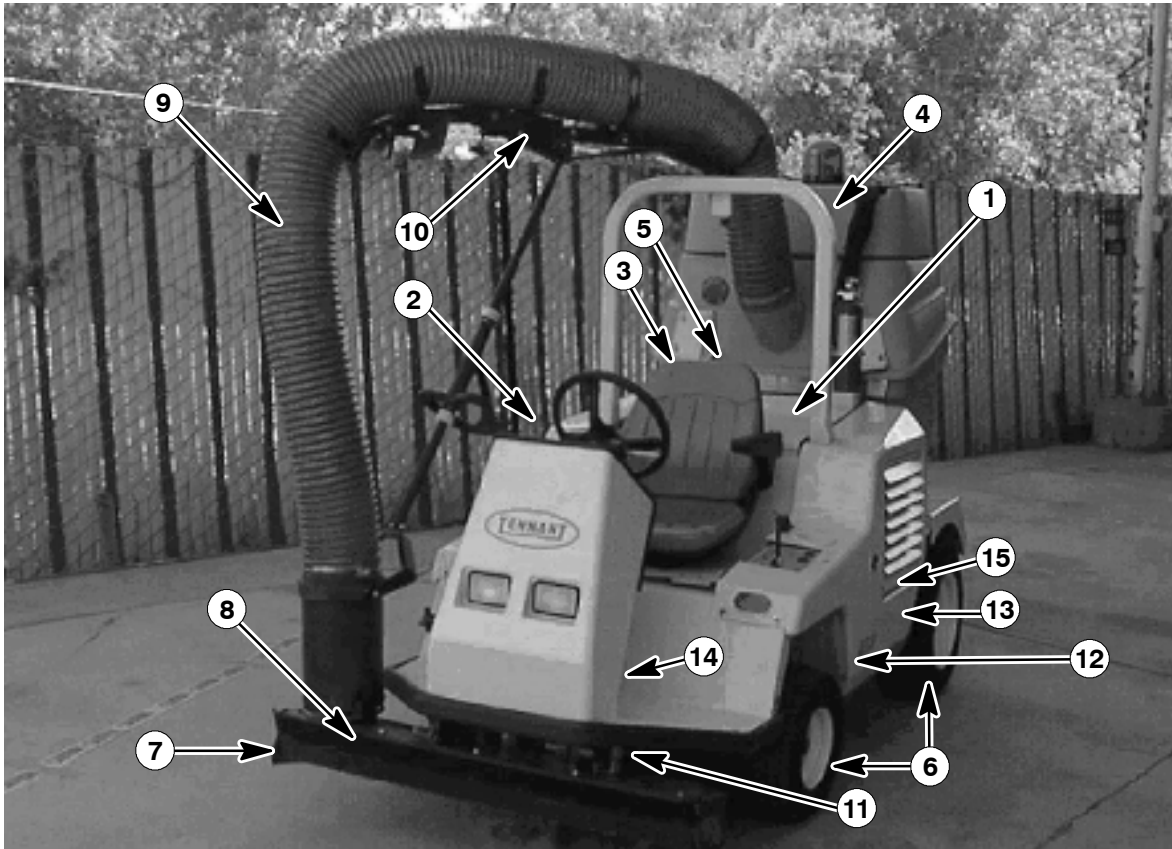

MAINTENANCE CHART

Interval	Key	Description	Procedure	Lubricant/ Fluid	No. of Service Points	
Daily	1	Engine air filter	Check indicator	-	1	
		Engine dust cap	Empty	-	1	
		Engine crankcase	Check oil level	EO	1	
	2	Radiator	Check and clean inlet screen	-	1	
			Check coolant level in overflow reservoir	WG	1	
	10	Vacuum hose support arm	Check for damage and wear	-	3	
			Check gas cylinders for wear	-	2	
	7	Vacuum head skirts (option)	Check for damage and wear	-	1	
	8	Vacuum head (option)	Check for damage, wear, and adjustment	-	1	
			Check for blockage	-	1	
	9	Vacuum hose	Check for damage and blockage	-	1	
	4	Vacuum fan screen	Check for debris and clean	-	1	
			Vacuum bag	Check for debris and clean	-	1
			Dust filter bag (option)	Check for debris and clean	-	1
			Dust panel filter (option)	Check for debris and clean	-	1
Water dust control (option) spray nozzle			Check for debris and adjustment	-	1	

Interval	Key	Description	Procedure	Lubricant/ Fluid	No. of Service Points
50 Hours	5	Fuel lines and clamps	Check for tightness and wear		4
	2	Radiator core	Check and clean	-	2
	3	Hydraulic cooler core	Check and clean	-	1
	6	Tires	Check pressure	-	4
100 Hours	1	Engine crankcase	■ Change oil and filter element	EO	1
		Engine fan belt	Check tension	-	1
		Engine air filter	Replace	-	1
		Hydraulic reservoir	Check fluid level	-	6
	4	Vacuum bag	Check for wear and damage	-	1
		Dust panel filter (option)	Check for wear and damage	-	1
200 Hours	2	Radiator hoses and clamps	Check for tightness and wear	-	2
	11	Steering cylinder	Lubricate steering cylinder	SPL	2
	13	Brakes	Check brake adjustment	-	2
	12	Wheel pivot points	Lubricate pivots	SPL	2
	5	Fuel filter	Replace	-	1
	5	Fuel screen	Clean	-	1
	6	Tires	Check wear and rotate	-	4
	3	Hydraulic hoses	Check for wear and damage	-	All
	1	Battery	■ Clean and tighten battery cable connections	-	1
			Check electrolyte level	DW	1
	14	Directional pedal	Check for wear, lubricate	-	2
	1	Engine door seals	Check for wear	-	4
	4	Water dust control (option) waterlines and clamps	Check for tension and wear	-	6
	-	Windshield wiper blades (option)	Check for wear	-	2
800 Hours	3	Hydraulic reservoir	Replace filler cap	-	1
	-	Hydraulic drive motors	Check for wear and damage	-	1
	2	Cooling system	Flush	WG	1
	6	Wheels	■ Check wheel nut torque	-	4
1200 Hours	3	Hydraulic fluid filter	* Change filter element	-	All
2400 Hours	3	Hydraulic fluid reservoir	* Replace suction strainer	-	1
			* Change hydraulic fluid	HYDO	1

NOTE: Change the hydraulic fluid, filter, and suction strainer, indicated (), after every 800 hours for machines NOT originally equipped with **TennantTrue** premium hydraulic fluid. (See Hydraulics section).*

LUBRICANT/FLUID

EO Engine oil, API diesel classification CF or better

HYDO . **TennantTrue** premium hydraulic fluid or equivalent

SPL . . . Special lubricant, Lubriplate EMB grease (TENNANT part no. 01433-1)

WG . . . Water and permanent-type ethylene glycol anti-freeze, -34° C (-30° F)

DW Distilled water

Note: Also check procedures indicated (■) after the first 50-hours of operation.

Note: More frequent intervals may be required in extremely dusty conditions.

LUBRICATION

A. STEERING CYLINDER

The steering cylinder has two grease fittings. Lubricate with Lubriplate EMB grease (TENNANT part no. 01433-1) after every 200 hours of operation.

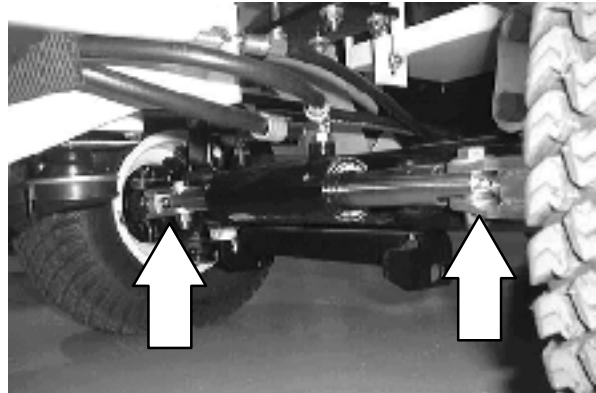

B. WHEEL PIVOTS POINTS

The wheel pivots points have two grease fittings. Lubricate with Lubriplate EMB grease (TENNANT part no. 01433-1) after every 200 hours of operation.

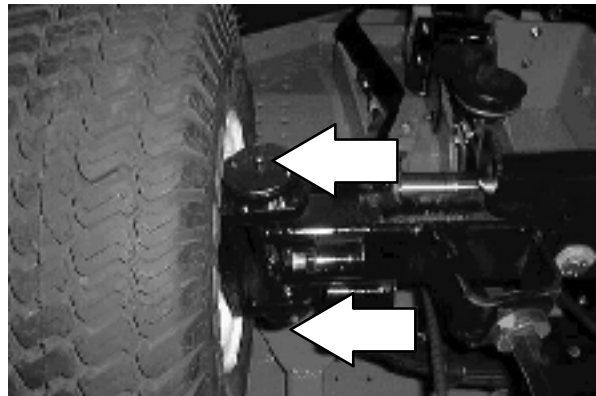

C. ENGINE

Check the engine oil level daily. The engine oil dipstick can be accessed by lifting up the engine cover. Change the engine oil and oil filter after every 100 hours of machine operation.

 **WARNING: Moving fan blades.**
Keep away.

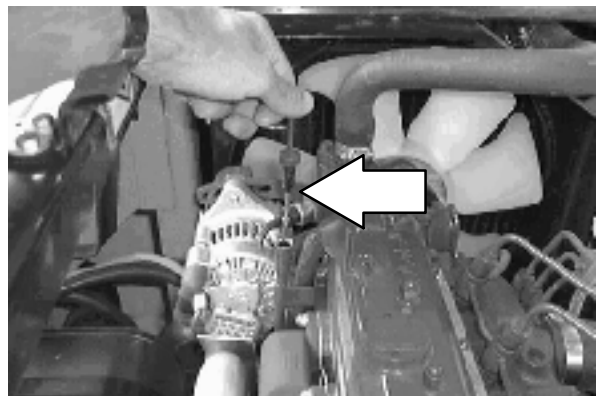

HYDRAULICS

HYDRAULIC FLUID RESERVOIR

The reservoir is located on the left side of the machine next to the engine.

A filler cap is mounted on top of the reservoir. It has a built in breather and fluid level dipstick. Replace the cap after every 800 hours of operation.

Check the hydraulic fluid level at *operating temperature* every 100 hours. The dipstick is marked with full and add markings to indicate the level of hydraulic fluid in the reservoir. Cold fluid level is mid-point of add and full lines.

Lubricate the filler cap gasket with a film of hydraulic fluid before putting the cap back on the reservoir.

ATTENTION! Do not overfill the hydraulic fluid reservoir or operate the machine with a low level of hydraulic fluid in the reservoir. Damage to the machine hydraulic system may result.

Drain and refill the hydraulic fluid reservoir with new **TennantTrue** premium hydraulic fluid after every 2400 hours of operation. Machines have a blue colored drop (left photo) on the hydraulic fluid label if originally equipped with **TennantTrue** premium hydraulic fluid.



TennantTrue Fluid



Previous Fluid

*NOTE: Change the hydraulic fluid, filter, and suction strainer after every 800 hours for ALL machines that have NOT consistently used **TennantTrue** premium hydraulic fluid or equivalent.*

The reservoir has a built-in strainer outlet that filters hydraulic fluid before it enters the system. Replace the strainer after every 2400 hours of operation.

MAINTENANCE

The hydraulic fluid filter is located in front of the hydraulic reservoir near the rear of the engine compartment. Replace the filter element after every 1200 hours of operation or if the clogged hydraulic filter light remains on. Check the hydraulic fluid level and refill as needed.



HYDRAULIC FLUID

There are two fluids available for different temperature ranges:

TennantTrue premium hydraulic fluid (Extended Life)			
Part number	Ambient temperature	ISO Grade	Capacity
1057710	above 7° C (45° F)	100	3.8 L (1 gal)
1057711	above 7° C (45° F)	100	19 L (5 gal)
1057707	below 7° C (45° F)	32	3.8 L (1 gal)
1057708	below 7° C (45° F)	32	19 L (5 gal)

If using a locally-available hydraulic fluid, be sure the specifications match the Tennant hydraulic fluid specifications. Substitute fluids can cause premature failure of hydraulic components.

ATTENTION! Hydraulic components depend on system hydraulic fluid for internal lubrication. Malfunctions, accelerated wear, and damage will result if dirt or other contaminants enter the hydraulic system.

HYDRAULIC HOSES

Check the hydraulic hoses every 200 hours of operation for wear or damage.

Fluid escaping at high pressure from a very small hole can be almost invisible, and can cause serious injuries.

See a doctor at once if injury results from escaping hydraulic fluid. Serious infection or reaction can develop if proper medical treatment is not given immediately.

**FOR SAFETY: When Servicing Machine,
Use Cardboard To Locate Leaking
Hydraulic Fluid Under Pressure.**

If you discover a fluid leak, contact your mechanic/supervisor.

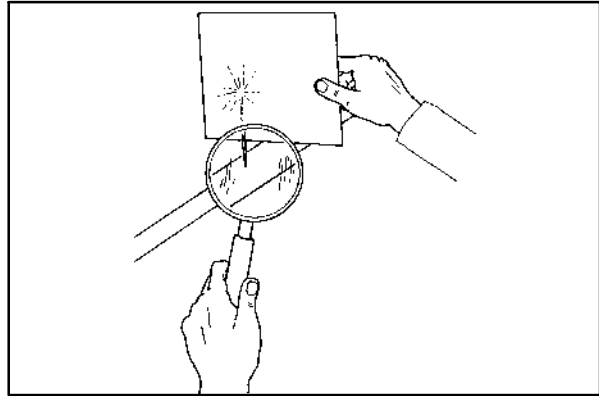

00002

ENGINE

COOLING SYSTEM

Check the radiator coolant level daily in the overflow reservoir. Use clean water mixed with a permanent-type, ethylene glycol antifreeze to a -34°C (-30°F) rating. Add coolant to the overflow reservoir.

FOR SAFETY: When Servicing Machine, Avoid Contact With Hot Engine Coolant.

Check the radiator hoses and clamps every 200 hours of operation. Tighten the clamps if they are loose. Replace the hoses and clamps if the hoses are cracked, harden, or swollen.

Check the inlet screen for debris daily. Blow or rinse all dust, which may have collected on the screen, opposite the direction of normal air flow.

Check the radiator and hydraulic cooler for debris every 50 hours of operation. Spray the radiator with compressed air or a pressure washer from the inside, opposite the direction of normal air flow. Be careful not to bend the cooling fins when cleaning or rinsing off the radiator or hydraulic cooling system. Clean thoroughly to prevent the fins becoming encrusted with dust. Clean the radiator and cooler only after the radiator has cooled to avoid cracking.

FOR SAFETY: When Servicing Machine, Wear Eye And Ear Protection When Using Pressurized Air Or Water.

Flush the radiator and the cooling system every 800 hours of operation, using a dependable cleaning compound.

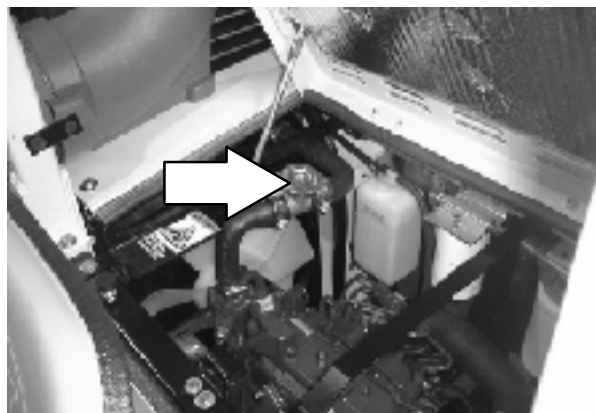

AIR FILTER INDICATOR

The air filter indicator shows when to replace the air filter element. Check the indicator daily. The indicator's red line will move as the air filter element fills with dirt. Do not replace the air filter element until the red line reaches 5 kPa (20 in H₂O) and the "SERVICE WHEN RED" window is filled with red. The indicator's red line may return to a lower reading on the scale when the engine shuts off. The red line will return to a correct reading after the engine runs for a while.

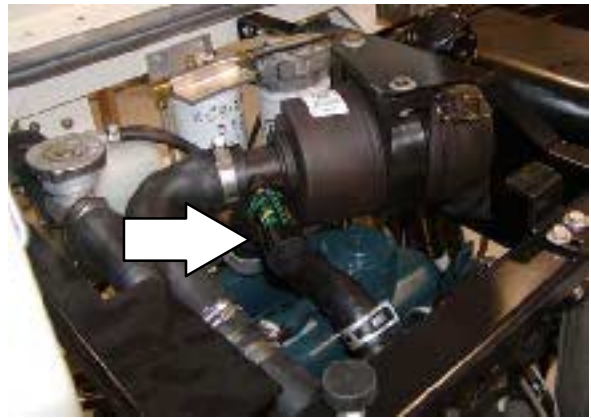

Reset the air filter indicator by pushing the reset button on the end of the indicator after replacing the air filter element.

AIR FILTER

The engine air filter housing has a dust cap and a dry cartridge-type air filter element. Empty the dust cap daily. Replace the dust cap if the rubber is worn.

The air filter element must be replaced whenever it is damaged or when the air filter indicator shows a restriction. The air filter cannot be cleaned.

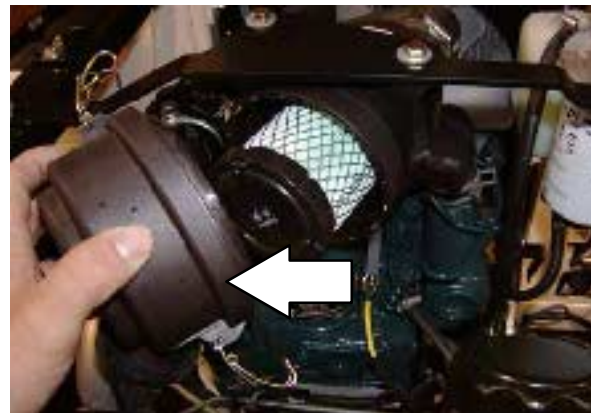

Replace the air filter element only when the *air filter indicator* shows restriction in the air intake system. Do not remove the air filter element from the housing unless it is restricting air flow.

After the air filter is replaced, carefully clean the end cap and the interior of the housing with a damp cloth. Clean the housing sealing surfaces.

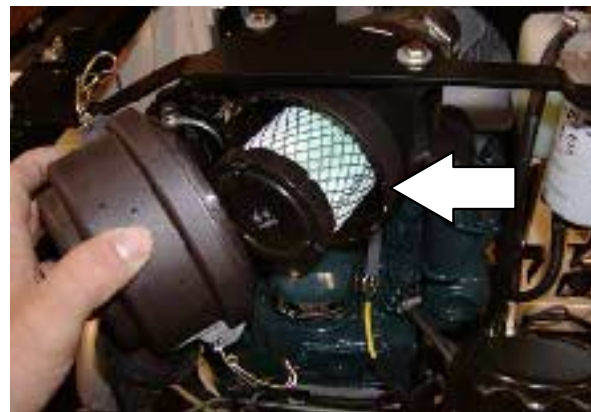

MAINTENANCE

FUEL FILTER

The fuel filter cartridge filters impurities from the fuel. It is located at the rear of the engine compartment.

Replace the fuel filter element every 200 hours of operation.

FOR SAFETY: When Servicing Machine, Keep Flames And Sparks Away From Fuel System Service Area. Keep Area Well Ventilated.

Check the fuel screen on the end of the fuel line in the fuel tank for debris every 200 hours.



FUEL LINES

Check the fuel lines every 50 hours of operation. If the clamp band is loose, apply oil to the screw of the band, and securely tighten the band.

Made of rubber, the fuel lines may become worn out whether the engine has been used much or not. Replace the fuel lines and hose clamps every two years.

FOR SAFETY: When Servicing Machine, Keep Flames And Sparks Away From Fuel System Service Area. Keep Area Well Ventilated.

If the fuel lines and hose clamps are found worn or damaged before two years' time, replace or repair them at once. Bleed the fuel system after replacement of any of the fuel lines. When the fuel lines are not installed, plug both ends with clean cloth or paper to prevent dirt from entering the lines. Dirt in the lines can cause fuel injection pump malfunction.

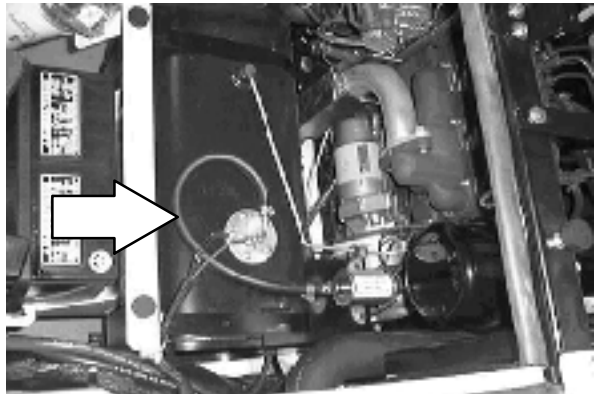

4 POST ROPS WIPER BLADES (OPTION)

Check the windshield wiper blades for wear every 200 hours of operation. Replace when necessary.

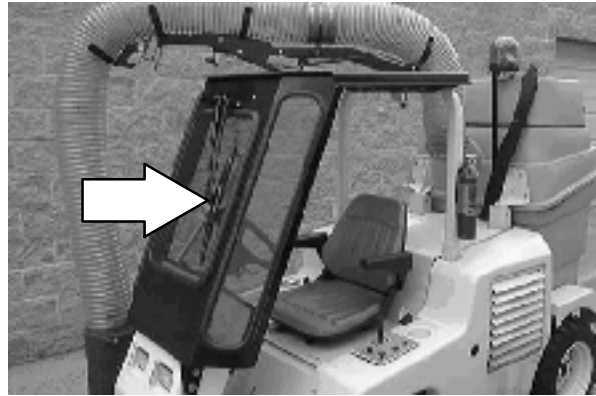

BATTERY

The battery is located under the operator's seat and can be accessed by lifting the seat up.

After the first 50 hours of operation, and every 200 hours after that, clean and tighten the battery connections.

Check the electrolyte level every 200 hours of operation. Only add distilled water.

**FOR SAFETY: When Servicing Machine,
Avoid Contact With Battery Acid.**

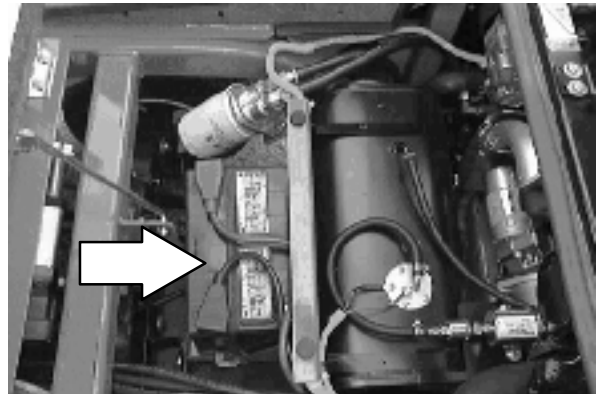

BELTS

ENGINE BELT

The engine fan belt is driven by the engine crankshaft pulley and drives the alternator pulley. Proper belt tension is 10 mm (0.40 in) from a force of 4 to 5 kg (8 to 10 lb) applied at the mid-point of the longest span.

Check and adjust the belt tension every 100 hours of operation.

 **WARNING: Moving Belt And Fan Blades. Keep Away.**

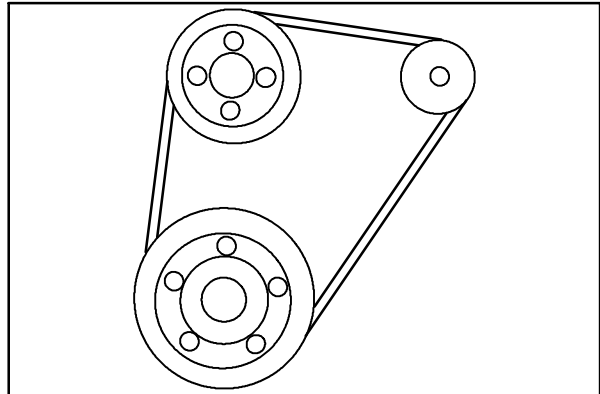

SKIRTS AND SEALS

DOOR SEALS

Seals are located along the edges of the engine compartment and the engine access doors.

Check the seals for wear or damage every 200 hours of operation.

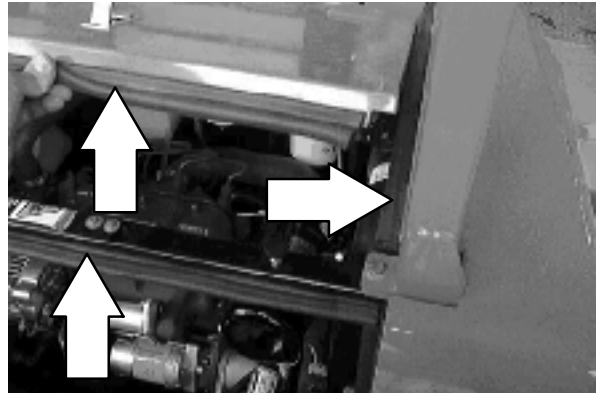
**VACUUM HEAD SKIRTS (OPTION)**

The vacuum head skirts are located on the bottom of the vacuum head.

Check the skirts for wear or damage daily.

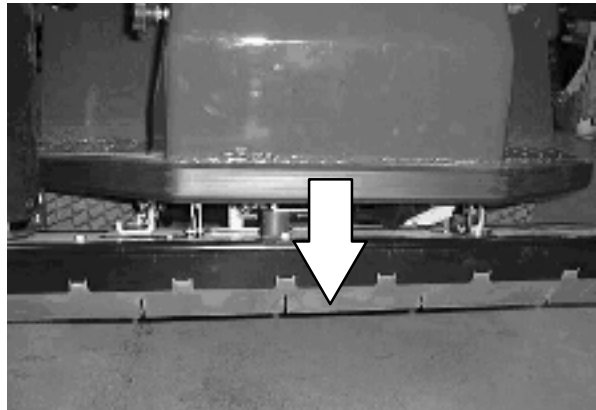

BRAKES AND TIRES

SERVICE BRAKES

The cable actuated service brakes are located on both rear wheels. The cables can be adjusted at the front end or at the rear wheel. Check the brake adjustment after every 200 hours of operation.

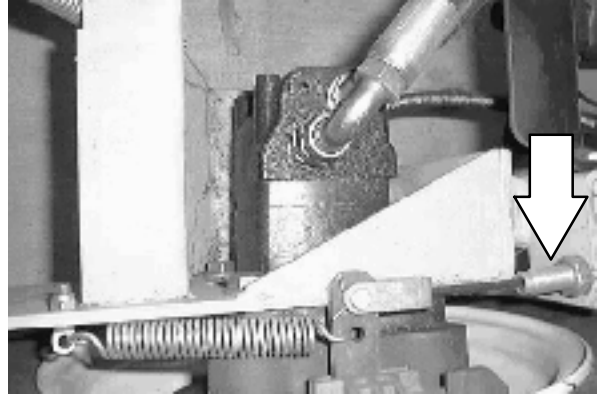

PARKING BRAKE

The parking brakes are set with the *parking brake pedals*. The parking brakes lock the service brakes in place. The parking brakes are adjusted with the service brakes.

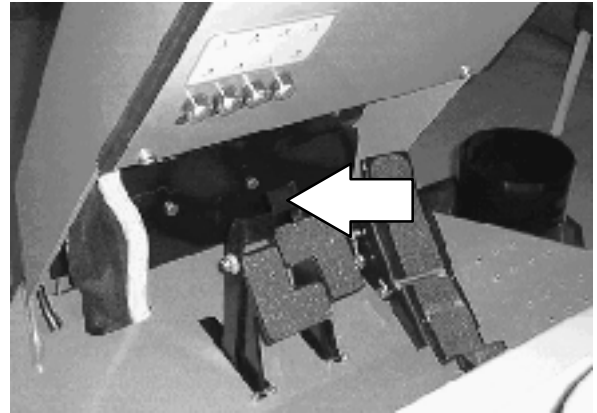

TIRES

The standard front and rear machine tires are pneumatic. Check the tire pressure after 50 hours of operation and after every 800 hours of operation.

The proper front tire air pressure is 152 kpa (22 psi).

The proper rear tire air pressure is 124 kpa (18 psi).



The proper rear traction tire (option) air pressure is 48 kpa (7 psi)



FRONT WHEEL

Torque the front wheel nuts in a star pattern twice to 126-154 Nm (90-110 ft. lbs) after every 100 hours of operation.

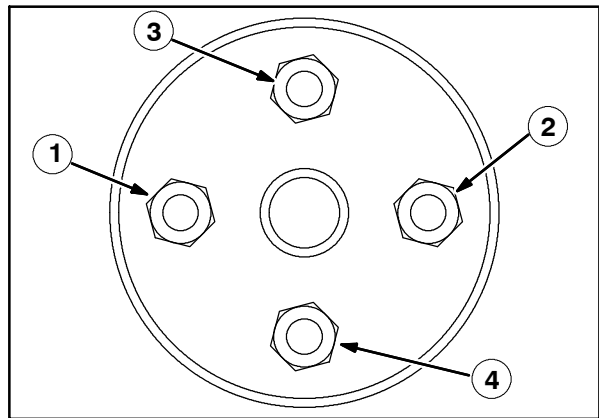

REAR WHEEL

Torque the rear wheel nuts in a star pattern twice to 126-154 Nm (90-110 ft. lbs) after every 100 hours of operation.

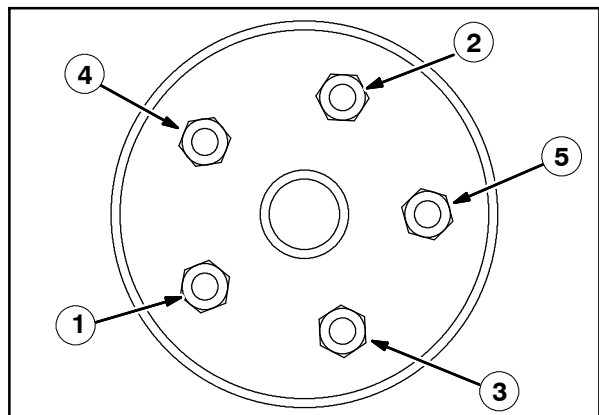

VACUUM SYSTEM

VACUUM BAG

The vacuum bag is located on the back of the debris hopper. Check the vacuum bag for debris and damage daily.

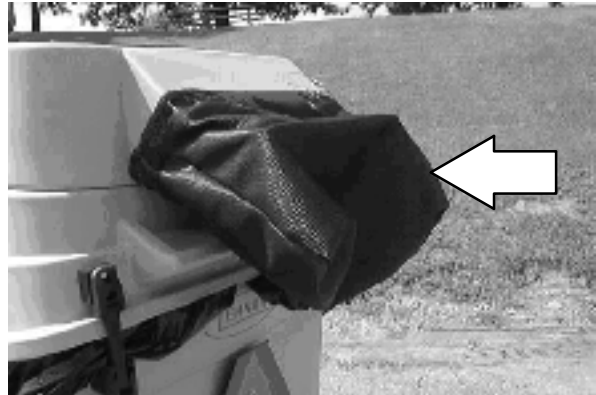

DUST PANEL FILTER (OPTION)

The dust panel filter is located inside the louver panel on the dust filter panel housing. Check the dust filter panel every time you empty the vacuum bag.

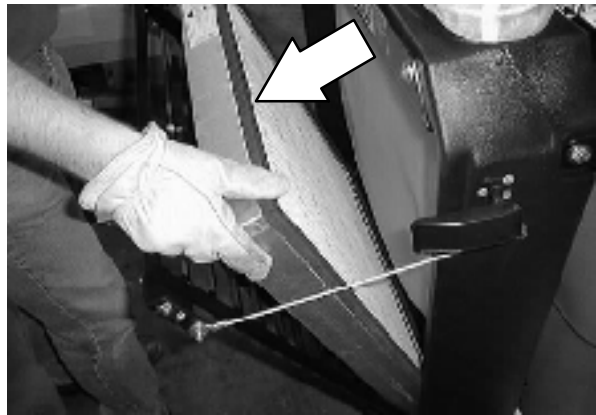

DUST FILTER BAG (OPTION)

The dust filter bag is located on the back of the debris hopper. Check the dust filter bag for debris and damage daily.



VACUUM FAN

The vacuum fan is located in the top half of the debris hopper. Check the fan screen for debris every time you empty the hopper.

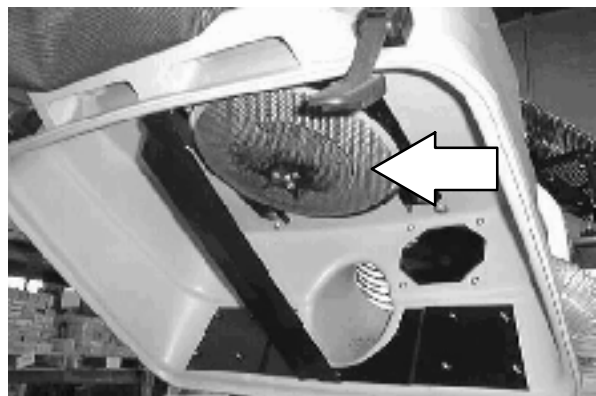

**VACUUM WAND w/ 15 FOOT EXTENSION
(OPTION)**

Check the vacuum wand for blockage and damage daily.



Remove plug from push/pull gate valve and check for blockage and damage daily.

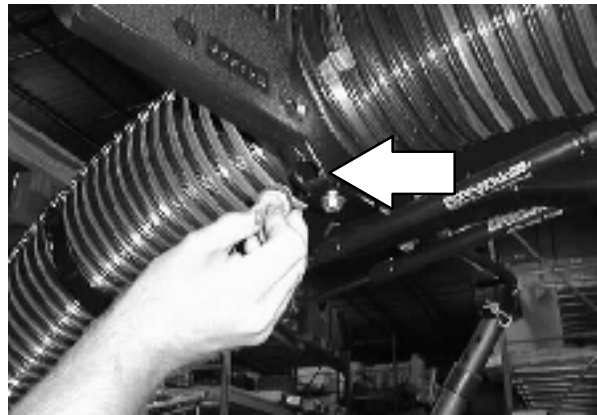

VACUUM HEAD (OPTION)

Check the vacuum head for blockage and damage daily.

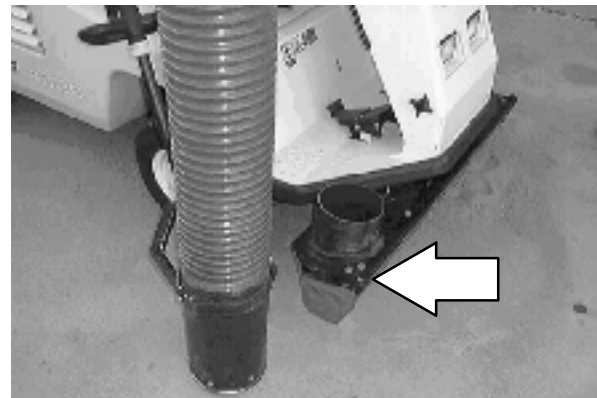

MAINTENANCE

VACUUM HOSE AND SUPPORT ARM

Check the vacuum hose for blockage and damage daily. Wash the hose out with water to remove sand and/or dirt buildup if necessary.

Check the gas spring supports for proper support every 200 hours of operation.

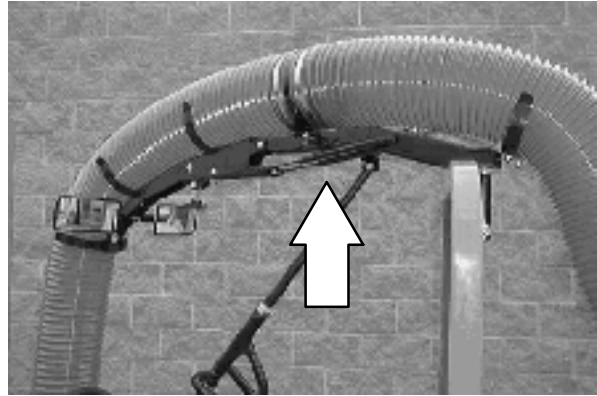

TO CHECK GAS SPRING SUPPORTS FOR PROPER EXTENSION:

1. Turn the hose support adjustment knob counterclockwise until the arm is raised to the maximum height.
2. Bounce the end of the hose down and allow it to rise without any interference. The end of the hose should rest approximately 102 mm to 153 mm (4 in to 6 in) off the ground when it comes to rest.

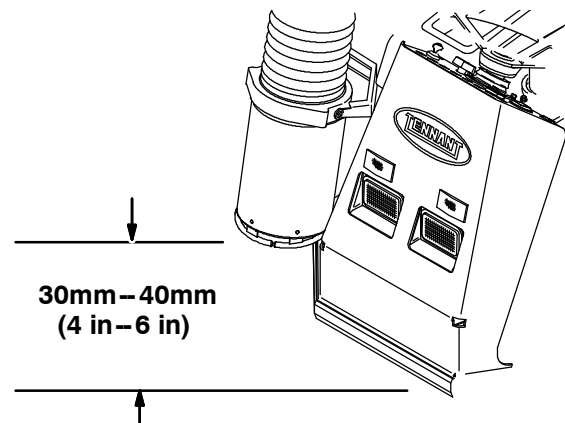

3. Check the center to center distance on the gas spring. If the distance is less than 400 mm (15.75 in), the gas springs may need replacing.

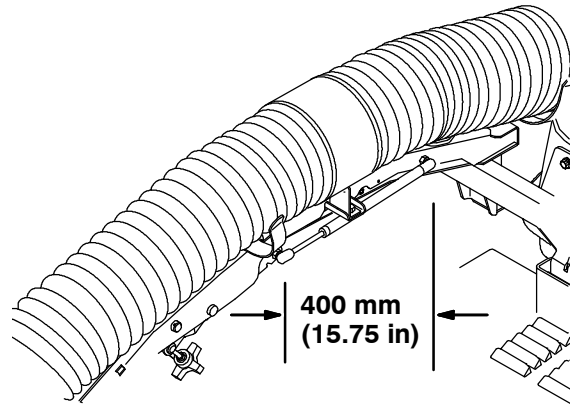

4. The vacuum hose may stretch over time. When the center to center distance on the gas springs is correct, but the hose is still less than 102 mm (4 in) off the ground, the hose may be cut.

MAINTENANCE

WATER DUST CONTROL (OPTION)

SPRAY NOZZLE

Check the spray nozzle daily for debris and adjustment. Spray the vacuum fan housing out with a garden hose daily to keep the debris canister nozzle clean.

FOR SAFETY: Wear eye and ear protection if using pressurized air or water.

If the spray nozzle becomes blocked or clogged, it will need to be removed and cleaned.

CLEANING AND ADJUSTING THE SPRAY NOZZLE

1. Stop the machine, set the parking brake and turn off the machine power.

FOR SAFETY: Before leaving or servicing machine, stop on level surface, set the parking brake, turn off machine and remove key.

2. Turn the plastic nozzle head 1/4 turn counterclockwise and pull straight out to remove it.

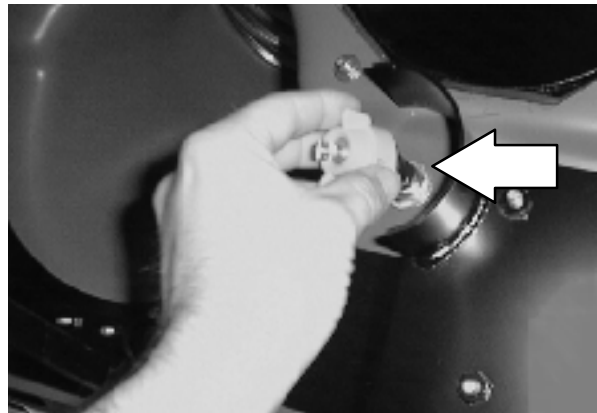

3. Remove and clean the spray nozzle filter screen.

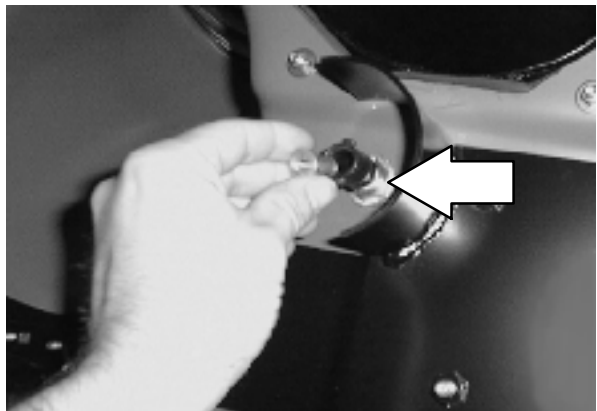

4. Use a piece of fine stripped electrical wire to remove any blockage from the spray nozzle.
5. Replace the filter screen and reassemble the spray nozzle. Press the spray nozzle head back into position, and secure with a 1/4 clockwise turn.
6. Turn the machine power on. Press the vacuum fan switch on.
7. Press the water dust control switch on.
8. Use a standard screwdriver to turn the spray nozzle head and adjust the spray pattern while the nozzle is spraying.
9. The adjusted debris canister spray nozzle should spray over the vacuum hose opening.

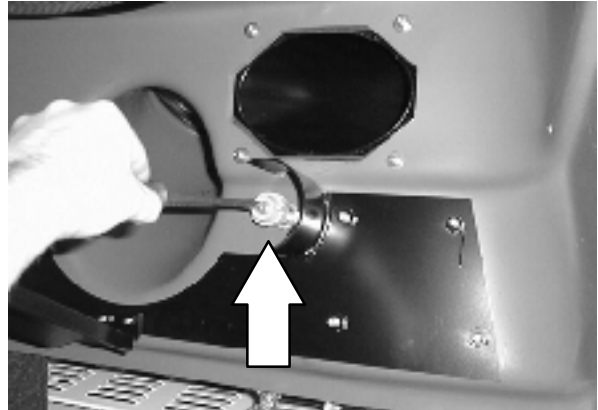
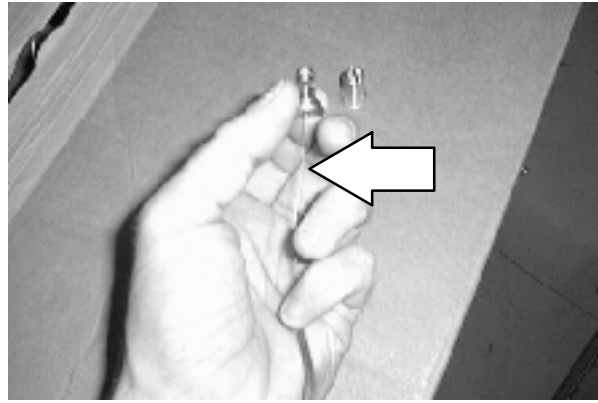

WATER TANK

The water tank holds up to 30 L (8 gal) of water for the dust control system.

The tank should be drained before storing the machine for an extended period of time.



Check the water lines and clamps for damage, tension and wear every 200 hours.

DRAINING THE WATER TANK

1. Stop the machine, set the parking brake and turn off the machine power.

FOR SAFETY: Before leaving or servicing machine, stop on level surface, set the parking brake, turn off machine and remove key.

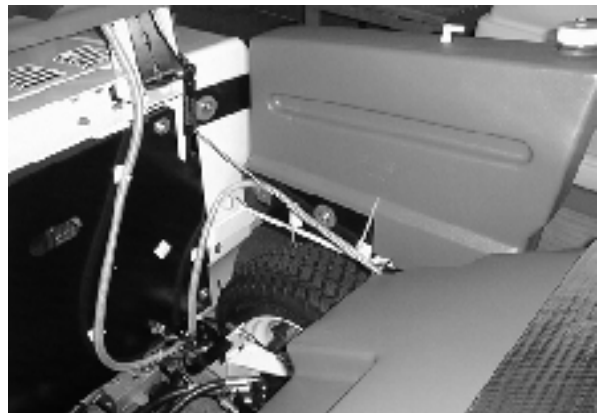

MAINTENANCE

2. Turn the plastic nozzle head 1/4 turn counterclockwise and pull straight out to remove it.

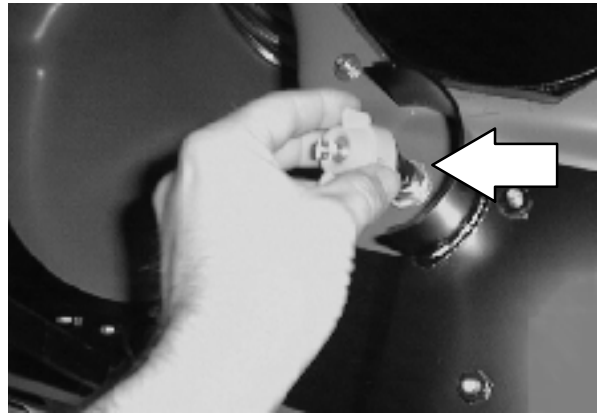

3. Remove the spray nozzle filter screen.

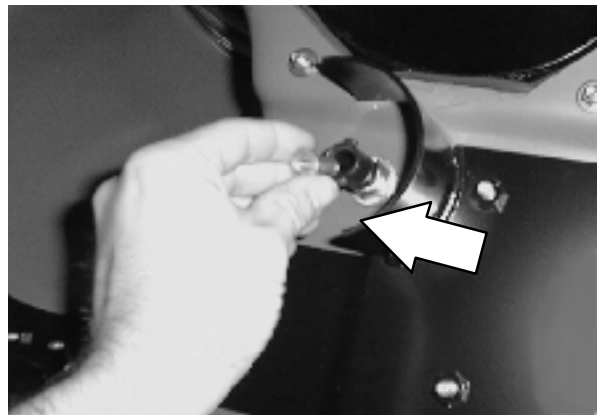

4. Turn the machine power on. Press forward on the water dust control switch to turn on the water dust control.
5. Allow the pump to operate until all of the water drains out of the water tank.
6. Press backwards on the water dust control switch to turn the water dust control switch off.
7. Turn the machine power off.
8. Replace the filter screen and spray nozzle head on the machine.

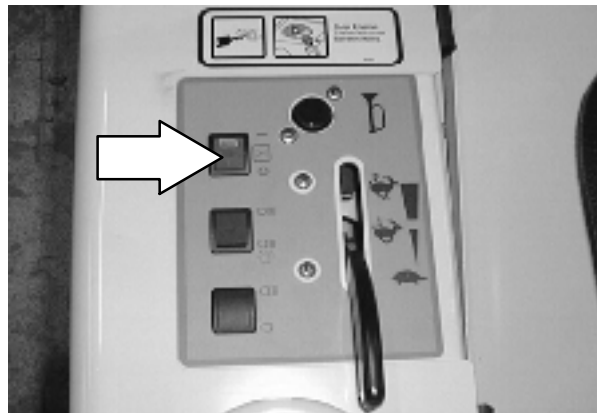

PUSHING, TOWING, AND TRANSPORTING THE MACHINE

PUSHING OR TOWING THE MACHINE

If the machine becomes disabled, it can be pushed from the front or rear, but towed only from the front.

The propelling pump has a bypass valve to prevent damage to the hydraulic system when the machine is being pushed or towed. This valve allows a disabled machine to be moved for a *very short distance* and at a speed to not exceed 1.6 kp/h (1 mph). The machine is NOT intended to be pushed or towed a long distance or at a high speed.

ATTENTION! Do not push or tow machine for a long distance and without using the bypass valve, or the machine hydraulic system may be damaged.

Turn the bypass valve 90° from the normal position before pushing or towing the machine. **The illustration shows the bypass valve in the pushing or towing position.**

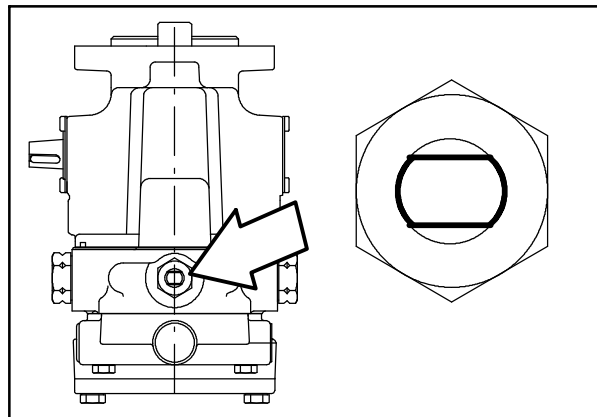
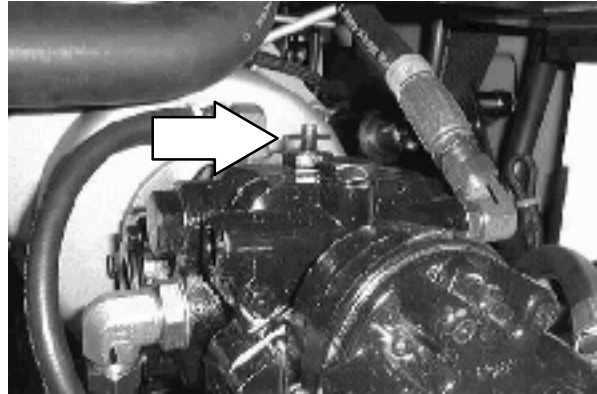

TRANSPORTING THE MACHINE

1. Position the rear of the machine at the loading edge of the truck or trailer.

FOR SAFETY: Use truck or trailer that will support the weight of the machine.

NOTE: Empty the hopper before transporting the machine.

2. If the loading surface is not horizontal or is higher than 380 mm (15 in) from the ground, use a winch to load machine.

If the loading surface is horizontal AND is 380 mm (15 in) or less from the ground, the machine may be driven onto the truck or trailer.

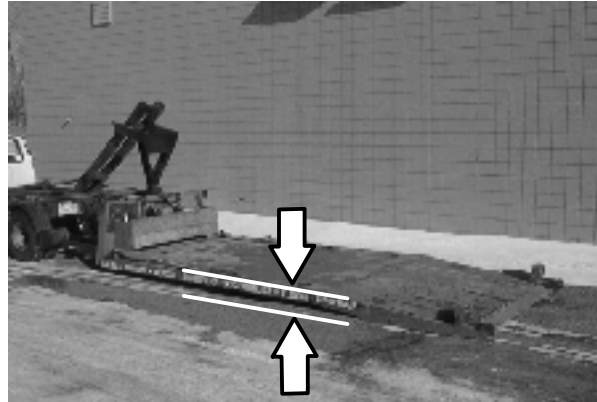

3. To winch the machine onto the truck or trailer, attach the winching chains to the rear tie down locations. The rear tie-down locations are through the rear holes of the frame.

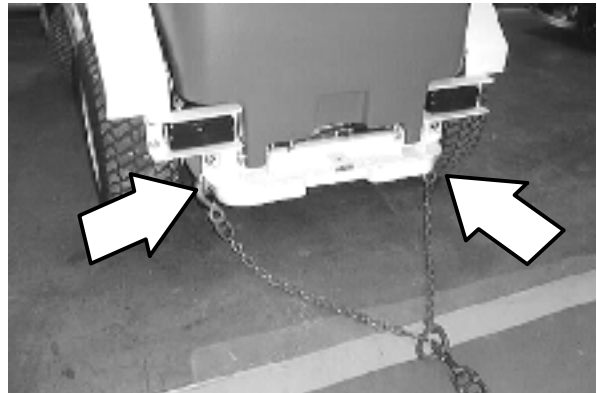

4. Turn the bypass valve 90° from the normal position before winching the machine onto the truck or trailer. See *PUSHING OR TOWING THE MACHINE* section of this manual. Make sure the machine is centered.

FOR SAFETY: When loading machine onto truck or trailer, use winch. Do not drive the machine onto the truck or trailer unless the loading surface is horizontal AND is 380 mm (15 in) or less from the ground.

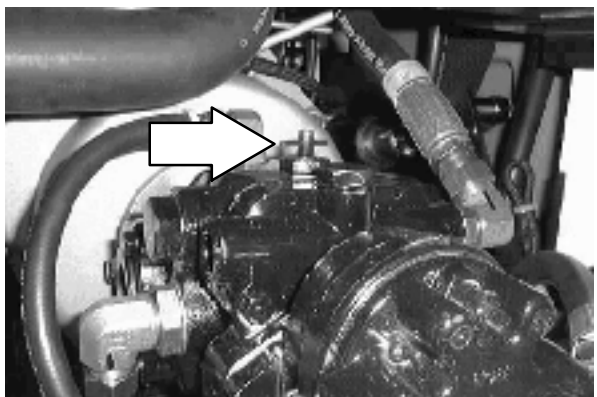

5. Position the machine onto the truck or trailer as far as possible. If the machine starts to veer off the centerline of the truck or trailer, stop and turn the steering wheel to center the machine.

- Set the parking brake, lower the vacuum head and block the machine tires. Tie down the machine to the truck or trailer before transporting.

If the machine does not have the optional tie down bracket, tie the front end down with a tie strap over the floor of the machine.

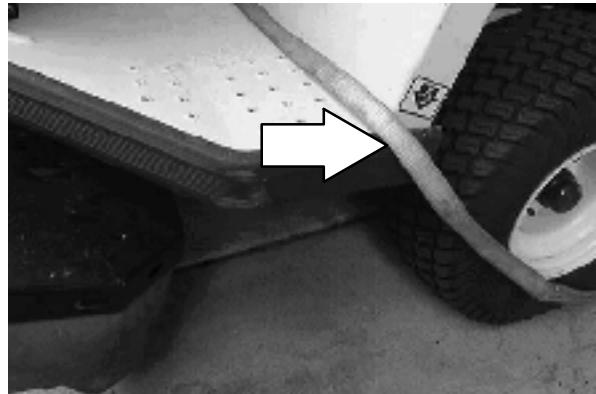

If the machine does have an optional tie down bracket, tie down the machine to the truck or trailer with it.

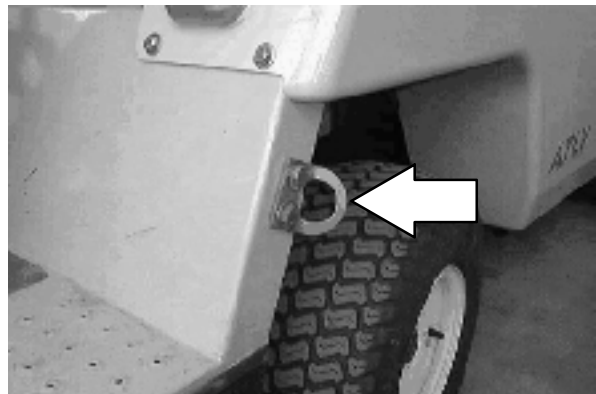

The rear tie-down locations are through the rear holes of the frame.

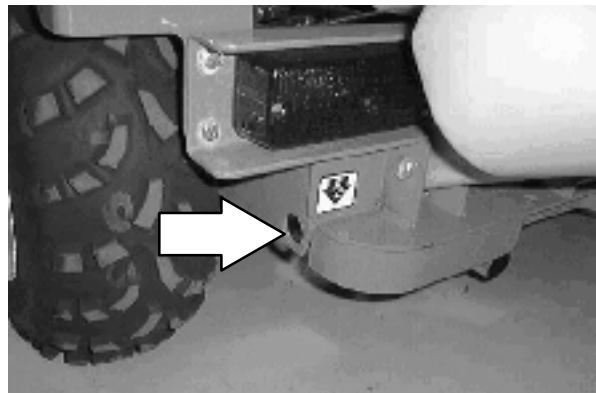

- If the loading surface is not horizontal or is higher than 380 mm (15 in) from the ground, use a winch to unload machine.

If the loading surface is horizontal AND is 380 mm (15 in) or less from the ground, the machine may be driven off the truck or trailer.

FOR SAFETY: When unloading machine off truck or trailer, use winch. Do not drive the machine off the truck or trailer unless the loading surface is horizontal AND 380 mm (15 in) or less from the ground.

MAINTENANCE

MACHINE JACKING

Empty the hopper before jacking the machine. You can jack up the machine for service at the designated locations. Use a hoist or jack that will support the weight of the machine.

Always stop the machine on a flat, level surface and block the tires before jacking up the machine.

The front jacking locations are on the frame near the front tires.

FOR SAFETY: When Servicing Machine, Block Machine Tires Before Jacking Machine Up.

FOR SAFETY: When Servicing Machine, Jack Machine Up At Designated Locations Only. Block Machine Up With Jack Stands.

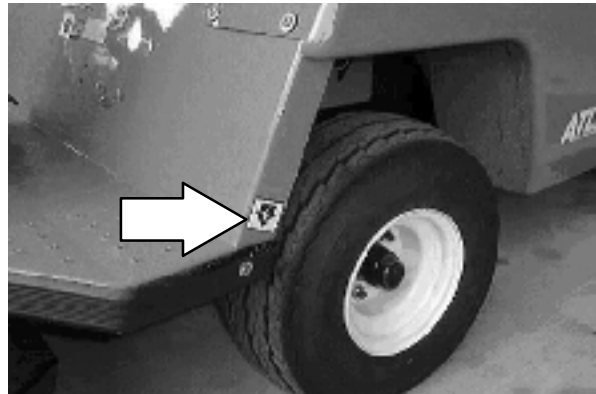

The rear jacking locations are below the rear bumper.

FOR SAFETY: When Servicing Machine, Block Machine Tires Before Jacking Machine Up.

FOR SAFETY: When Servicing Machine, Jack Machine Up At Designated Locations Only. Block Machine Up With Jack Stands.

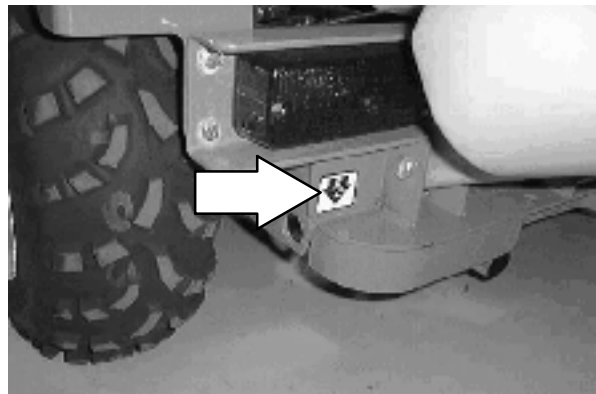

STORING MACHINE

Before storing the machine for an extended period of time, the machine needs to be prepped to lessen the chance of rust, sludge, and other undesirable deposits from forming. Contact TENNANT service personnel.

SPECIFICATIONS

SPECIFICATIONS

GENERAL MACHINE DIMENSIONS/CAPACITIES

Item	Dimension/capacity
Length	2590 mm (102 in)
Width	1680 mm (46 in)
Height	2113 mm (83 in)
Track	965 mm (38 in)
Wheelbase	1320 mm (52 in)
Hopper weight capacity	68 kg (150 lb)
Hopper volume capacity	416 L (110 gal)
Water dust control tank capacity (option)	30 L (8 gal)
GVWR	910 kg (2600 lb)
Axle rating (front and rear)	680 kg (1500 lb)
Vibration level at steering wheel does not exceed	2.5m/s ²
Vibration level at operator seat does not exceed	0.5m/s ²

GENERAL MACHINE PERFORMANCE

Item	Measure
Maximum forward speed	26 kmh (16 mph)
Maximum reverse speed	8 kmh (5 mph)
Minimum isle turn	4064 mm (160 in)
Minimum turning radius	457 mm (18 in)
Maximum rated climb and descent angle	12° / 21% Empty or Full hopper

STEERING

Type	Power source	Emergency steering
Front wheels, hydraulic cylinder, steering rod	Hydraulic accessory pump	Manual

HYDRAULIC SYSTEM

System	Capacity	Fluid Type
Hydraulic reservoir	19 L (5 gal)	ISO Grade 100 - above 7° C (45°F)
Hydraulic total	21 L (5.5 gal)	ISO Grade 32 - below 7° C (45°F)

POWER TYPE

Engine	Type	Ignition	Cycle	Aspiration	Cylinders	Bore	Stroke
Kubota	Piston	Diesel	4	Natural	3	78 mm (3.07 in)	78.5mm (3.09 in)
	Displacement		Net power, governed			Net power, maximum	
	1.1 L (60.9 cu in)		20.9 kw (28 hp) @ 3000 rpm Turbo engine-28.0 kw (38 hp)@ 3000			20.9 kw (28 hp) @ 3000 rpm Turbo engine-28.0 kw (38 hp)@ 3000	
	Fuel		Cooling system			Electrical system	
	Diesel Fuel tank: 31.42 L (8.3 gal) low sulfur fuel content less than 500ppm only		Water/ethylene glycol antifreeze			12 V nominal	
			Total: 4 L (1 gal)			30 A alternator	
						12V Battery - 730 cca	
	Idle speed, no load		Governed speed, under load				
	1200 rpm		3000 rpm maximum				
	Engine lubricating oil with filter						
5.2 L (5.5 qt) API diesel classification CF or better							

BRAKING SYSTEM

Type	Operation
Service brakes	Cable actuated disc brakes, one per each rear wheel
Parking brake	Utilize service brakes on rear wheels, cable actuated

TIRES

Location	Type	Size	Ply Rating	Pressure
Front (2)	Pneumatic	216 mm (8.5 in) x 457 mm (18 in)	4 Ply	152 kPa (22 psi)
Rear (2)	Pneumatic	216 mm (8.5 in) x 584 mm (23 in)	4 Ply	124 kPa (18 psi)
Rear (2) (Optional)	Pneumatic Traction	216 mm (8.5 in) x 584 mm (23 in)	4 Ply	48 kPa (7 psi)

SPECIFICATIONS

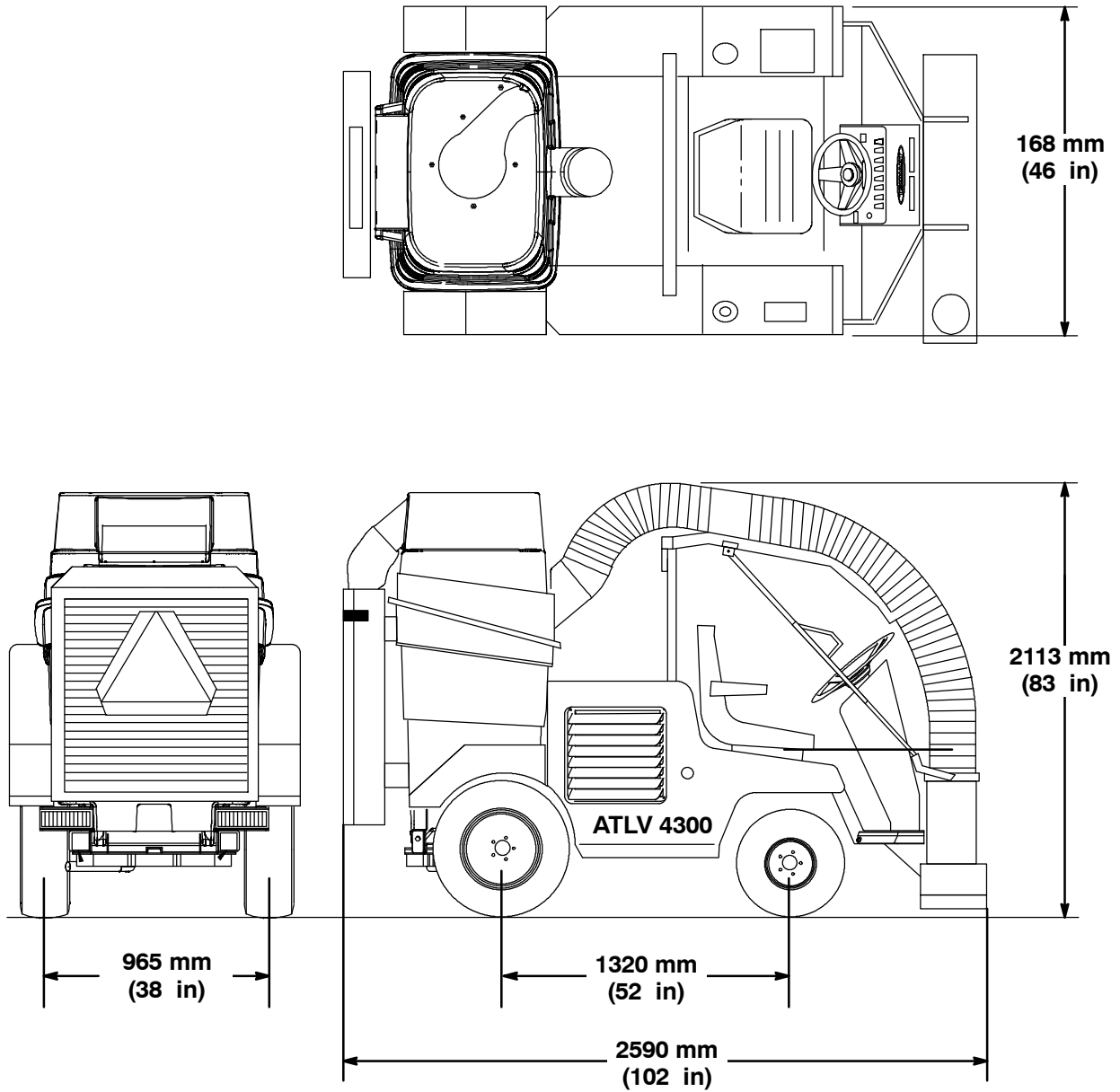

MACHINE DIMENSIONS

A

Air filter, 73
 Element, 73
 Replacing, 73–75
 Air filter indicator, 73

B

Bags
 Dust filter bag (option), 55–57, 80
 Hopper liner bag, 50–52
 Vacuum bag, 46–50, 80

Belts, 76
 Engine fan belt, 76

Brake pedals, 19

Brakes
 Parking, Adjustment, 78
 System specifications, 93

Bypass valve, 87

C

Capacities, 92

Caps
 Engine air filter, 73
 Hydraulic filler, 69

Charging system light, 14

Circuit breakers, 18

Controls
 Brake pedal, 19
 Charging system light, 14
 Circuit breakers, 18
 Directional pedal, 20
 Engine oil pressure light, 14
 Engine temperature light, 13
 Fuel level gauge, 13
 Fuse, 18
 Glow plug light, 15
 Hopper Tilt Bracket, 24
 Horn Button, 17
 Hourmeter, 13
 Hydraulic filter bypass light, 15
 Ignition switch, 11
 Latches, 25
 Levers, Steering wheel tilt, 11
 Operating lights switch, 16
 Operating/Hazard lights switch, 16
 Operation, 11
 Parking brake pedals, 19
 Parking break light, 15
 Rear view mirrors, 24
 Seat Belt, 17
 Steering wheel, 11

Symbols, 8–10
 Thermo Sentry warning light, 14
 Throttle lever, 17
 Vacuum fan switch, 12
 Vacuum head adjustment knob, 24
 Vacuum head switch, 12
 Vacuum hose support arm, 23
 Vacuum wand handle, 22
 Vacuum wand option, 57, 81
 Water dust control switch, 16
 Worklight switch, 16

Controls and Instruments, 9–11

D

Deluxe suspension seat, Adjustment, 21

Dimensions, 92

Dimensions, Machine, 94

Directional pedal, 20

Door, Engine, Latch, 25

Door seals, 77

Dust filter bag, Installation, 55

Dust filter bag (option), 55, 80

Dust panel filter (option), 80

E

Electrical
 Battery, 75
 Circuit breakers, 18
 Fuse, 18
 Ignition switch, 11

Emptying the hopper, 49–51

Emptying the vacuum bag, 46–50

Engine, 72
 Air filter, 73
 Replacing, 73–75
 Air filter dust cap, 73
 Air filter element, 73
 Air filter indicator, 27, 73
 Cooling system, 72
 Fan belt, 76
 Fuel filter, 74
 Fuel lines, 74
 Lubrication, 68
 Oil, 68
 Oil Pressure, Light, 14
 Specifications, 93

Engine oil pressure light, 14

Engine temperature light, 13

F

Fence line attachment , Installation, 59
Fence line attachment (option), 59
Filters
 Air filter, 73
 Dust filter bag (option), 55–57, 80
 Dust panel filter (option), 80
 Fuel filter, 74
 Hydraulic fluid filter, 70
 Panel filter kit (option), 61
Four post ROPS and weather shield, Operation,
 52–54
Front wheel, Torque, 79
Fuel filter, 74
Fuel level, 27
Fuel level gauge, 13
Fuel system, Fuel lines, 74
Fuse, 18

G

Gas spring supports, 82
 Adjustment, 82
Gauges, Fuel level , 13
Glow plug light, 15
GVWR, 6, 35, 92

H

Hazard lights, 16
Hopper , Tilt Bracket, 24
Hopper Tilt Bracket, 24
Horn button, 17
Hourmeter, 13
How the machine works, 26
Hydraulic
 Hoses, 71
 System specifications, 92
Hydraulic filter bypass light, 15
Hydraulic fluid, 70
Hydraulic fluid reservoir, 69
Hydraulic hoses, 71
Hydraulics, 69–71
 Filler cap, 69
 Fluid, 70
 Fluid filter, 70
 Fluid level, 69
 Reservoir, 69

I

Ignition switch, 11

J

Jack points, 90

K

Knobs, Vacuum head adjustment knob, 24

L

Latches, 25
 Engine door, 25
 Filter dust panel, 25
 Hopper, 25
 Hydraulic cooler, 26
 Vacuum bag quick release , 25
Lever, Turn signal , 12
Levers
 Steering wheel tilt, 11
 Throttle, 17
Lights
 Charging system, 14
 Engine oil pressure, 14
 Engine Temperature light, 13
 Glow plug, 15
 Headlights, 16
 Hydraulic filter bypass light, 15
 Operating , 16
 Operating/Hazard, 16
 Parking break , 15
 Signals, 16
 Thermo Sentry warning , 14
Lubrication, 68
 Engine, 68
 Wheel pivots points, 68

M

Machine components, 7
Machine dimensions, 94
Machine jacking, 90
Machine leaks, 26
Machine tie down location, 89
Maintenance, 66
 Air filter, 73
 Dust cap, 73
 Battery, 75
 Brakes, 78
 Cooling system, 72

Door seals, 77
 Dust filter bag (option), 80
 Dust panel filter (option), 80
 Engine, 72
 Engine belt, 76
 Flushing system, 72
 Fuel filter, 74
 Fuel lines, 74
 Hydraulic hoses, 71
 Inlet screen, 72
 Intervals, 66–68
 Steering cylinder, 68
 Parking brakes, 78
 Radiator hoses and clamps, 72
 Recommended, 6
 Service brakes, 78
 Storing machine, 90
 Support arm, 82
 Tires, 78–79
 Vacuum bag, 80
 Vacuum fan, 80
 Vacuum head, 81
 Vacuum head skirts, 77
 Vacuum hose, 82
 Vacuum system, 80
 Water dust control (option), 84
 Maintenance chart, 66–68

O

Operating lights, 16
 Operation, 6–58
 Emptying the hopper, 49–51
 Emptying the vacuum bag, 46–50
 Machine troubleshooting, 64
 On inclines, 37
 Over curbs, 38–39
 Post-operation checklist, 45
 Seat Belt, 17
 Starting the machine, 31–33
 Stop vacuuming, 42
 Stopping the machine, 44–46
 Vacuum bag, 46–50
 Vacuuming, 35–36, 39–42
 Operation on inclines, 37
 Operation over curbs, 38–39
 Operator Responsibility, 6
 Operator seat, 21
 Options, 52–58
 Deluxe suspension seat, 21
 Dust filter bag, 55, 80
 Dust panel filter, 80
 Fence line attachment, 59
 Four post ROPS and weather shield
 Operation, 52–54
 Windshield wiper, 52–54

Hydraulic filter bypass light, 15
 Operating/Hazard lights, 16
 Panel filter kit, 61
 Parking break light, 15
 ROPS, Wiper blades, 75
 Thermo Sentry warning light, 14
 Turn signal lever, 12
 Vacuum head
 Operation, 54–56
 Skirts, 77
 Vacuum head adjustment knob, 24
 Vacuum head switch, 12
 Vacuum wand, 57, 81
 Water dust control, 53, 84
 Water dust control switch, 16
 Worklight switch, 16

P

Panel filter kit (option), 61
 Cleaning, 63
 Emptying vacuum bag, 61
 Parking brake pedal, 19
 Parking break light, 15
 Pedals
 Brake, 19
 Directional, 20
 Parking brake, 19
 Post-operation checklist, 45
 Pre-operation checklist, 26–29
 Preheat, Glow plug, 15
 Pushing machine, 87
 Pushing or towing the machine, 87
 Pushing, towing, and transporting machine, 87

R

Radiator
 Coolant level, 72
 Coolant type, 72
 Exterior, 72
 Hoses, 72
 Rear view mirrors, 24
 Rear wheel, Torque, 79

S

Safety
 Labels, 5
 Precautions, 3–5
Safety element, 73
Seals, 77–79
Seat
 Adjustment, 21
 Deluxe Operators, 21
 Operator, 21
Seat Belt, 17
Skirts, 77
Specifications, 92–93
 Braking system, 93
 GVWR, 92
 Hydraulic system, 92
 Machine capacities, 92
 Machine dimensions, 92
 Machine performance, 92
 Power type, 93
 Steering, 92
 Tires, 93
Spray nozzle, 84
 Cleaning and adjusting the spray nozzle, 84
Starting the machine, 31–33
Steering, Specifications, 92
Steering cylinder, Lubrication, 68
Steering wheel, 11
Steering wheel tilt lever, 11
Stop vacuuming, 42
Stopping the machine, 44–46
Storing machine, 90
Support arm, 23
Switches
 Headlights, 16
 Ignition, 11
 Operating lights, 16
 Operating/Hazard lights, 16
 Vacuum fan, 12
 Vacuum head, 12
 Water dust control, 16
 Worklight, 16

T

Thermo Sentry warning light, 14
Throttle lever, 17
Tie down location, 89
Tires, 78–79
 Specifications, 93

Towing machine, 87
Transporting machine, 87
Transporting the machine, 88
Travel speed, 92
Troubleshooting, 64
Turn signal lever, 12
Turning radius, 92

V

Vacuum bag, 80
 Quick release strap latch, 25
Vacuum bag (For machines below serial number 001070), 46–48
Vacuum bag (For machines with serial number 001070 or above), 48–50
Vacuum fan switch, 12
Vacuum head, Adjustment, 54–56
Vacuum head (option), Operation, 54–56
Vacuum head adjustment knob, 24
Vacuum head skirts, 77
Vacuum head switch, 12
Vacuum hose, Removal from vacuum head, 22
Vacuum hose , Support arm, 23
Vacuum hose support arm, 23
 Adjustment, 23
Vacuum system, 80–81
Vacuum wand, Handle, 22
 Adjustment, 22
Vacuum wand (option), 57, 81
Vacuum wand handle, 22
Vacuum wand operation, 57
Vacuuming, 35–36, 39–42
Vacuuming and hose information, 35–36

W

- Water dust control (option), 53, 84
 - Filling the water tank, 53
 - Spray nozzle, 84
 - Water tank, 85
- Water dust control switch, 16
- Water tank, 85
 - Draining the water tank, 85
- Weather shield, 52–54
- Weight limit, 6, 35, 92
- Wheel pivots, Lubrication points, 68
- Wheels, Pivot points, Lubrication, 68
- Wiper blades, 75
- Worklight switch, 16

